

KENWOOD

TH-D72A/ TH-D72E



144/440 MHz FM DUAL BANDER/
144/430 MHz FM DUAL BANDER

INSTRUCTION MANUAL

144/440 MHz FM DOUBLE BANDE/
144/430 MHz FM DOUBLE BANDE

MODE D'EMPLOI

DOBLE BANDA DE 144/440 MHz EN FM/
DOBLE BANDA DE 144/430 MHz EN FM

MANUAL DE INSTRUCCIONES

Only basic operations are explained in this instruction manual.
For a detailed explanation on the operations, refer to the PDF file
supplied on the CD-ROM.

Seules les fonctions de base sont expliquées dans ce mode
d'emploi. Pour le détail sur les autres opérations, reportez-vous
au fichier PDF à votre disposition sur le CD-ROM.

En este manual de instrucciones solamente se explican las
operaciones básicas. Si desea obtener una descripción detallada
de las operaciones, consulte el archivo PDF correspondiente
incluido en el CD-ROM.

Kenwood Corporation

© B62-2235-10 (K, E)
09 08 07 06 05 04 03 02 01

CE 0682 Ⓢ

144/440 MHz FM DUAL BANDER/
144/430 MHz FM DUAL BANDER

TH-D72A/ TH-D72E

INSTRUCTION MANUAL

Kenwood Corporation

ENGLISH

NOTIFICATION

This equipment complies with the essential requirements of Directive 1999/5/EC.

The use of the warning symbol ⓘ means the equipment is subject to restrictions of use in certain countries.

This equipment requires a licence and is intended for use in the countries as below.

AT	BE	DK	FI	FR	DE	GR	IS
IE	IT	LI	LU	NL	NO	PT	ES
SE	CH	GB	CY	CZ	EE	HU	LV
LT	MT	PL	SK	SI	BG	RO	

THANK YOU

We are grateful you decided to purchase this **Kenwood** FM transceiver. **Kenwood** always provides Amateur Radio products which surprise and excite serious hobbyists. This transceiver is no exception. **Kenwood** believes that this product will satisfy your requirements for both voice and data communications.

The models listed below are covered by this manual.

TH-D72A: 144/440 MHz FM Dual Bander (The Americas)

TH-D72E: 144/430 MHz FM Dual Bander (Europe)

FEATURES

This transceiver has the following main features:

- A built-in GPS receiver unit.
- A built-in 5,000 point GPS Logger.
- A built-in TNC which conforms to the AX.25 protocol. With a portable computer, it allows you to easily enjoy Packet operation.
- Includes a program for dealing with data formats supported by Automatic Packet Reporting System (APRS®).
- Contains a total of 1000 Memory channels to program frequencies and other various data. Each Memory channel can be named using up to 8 alphanumeric characters.
- Continuous Tone Coded Squelch System (CTCSS) or Digital Coded Squelch (DCS) rejects unwanted calls from other stations.

WRITING CONVENTIONS FOLLOWED IN THIS MANUAL

The writing conventions described below have been followed to simplify instructions and avoid unnecessary repetition.

Instruction	Action
Press [KEY].	Momentarily press KEY.
Press [KEY] (1s).	Press and hold KEY for 1 second or longer.
Press [KEY1], [KEY2].	Press KEY1 momentarily, release KEY1, then press KEY2.
Press [F], [KEY].	Press the F key to enter Function mode, then press KEY to access its secondary function.
Press [KEY] + Power ON.	With the transceiver power OFF, press and hold KEY while turning the transceiver power ON.

Information on Disposal of Old Electrical and Electronic Equipment and Batteries (applicable for EU countries that have adopted separate waste collection systems)



Products and batteries with the symbol (crossed-out wheeled bin) cannot be disposed of as household waste.

Old electrical and electronic equipment and batteries should be recycled at a facility capable of handling these items and their waste byproducts. Contact your local authority for details in locating a recycle facility nearest to you. Proper recycling and waste disposal will help conserve resources whilst preventing detrimental effects on our health and the environment.

NOTICES TO THE USER

One or more of the following statements may be applicable:

FCC WARNING

This equipment generates or uses radio frequency energy. Changes or modifications to this equipment may cause harmful interference unless the modifications are expressly approved in the instruction manual. The user could lose the authority to operate this equipment if an unauthorized change or modification is made.

INFORMATION TO THE DIGITAL DEVICE USER REQUIRED BY THE FCC

This equipment has been tested and found to comply with the limits for a Class B digital device, pursuant to Part 15 of the FCC Rules. These limits are designed to provide reasonable protection against harmful interference in a residential installation.

This equipment generates, uses and can generate radio frequency energy and, if not installed and used in accordance with the instructions, may cause harmful interference to radio communications. However, there is no guarantee that the interference will not occur in a particular installation. If this equipment does cause harmful interference to radio or television reception, which can be determined by turning the equipment off and on, the user is encouraged to try to correct the interference by one or more of the following measures:

- Reorient or relocate the receiving antenna.
- Increase the separation between the equipment and receiver.
- Connect the equipment to an outlet on a circuit different from that to which the receiver is connected.
- Consult the dealer for technical assistance.

WHEN CONDENSATION OCCURS INSIDE THE TRANSCEIVER

Condensation may occur inside the transceiver in such a case where the room is warmed using a heater on cold days or where the transceiver is quickly moved from a cold room to a warm room. When condensation occurs, the microcomputer and/or the transmit/receive circuits may become unstable, resulting in transceiver malfunction. If this happens, turn OFF the transceiver and just wait for a while. When the condensation droplets disappear, the transceiver will function normally.



ATTENTION: (USA only)

The RBRC Recycle seal found on **Kenwood** lithium-ion (Li-ion) battery packs indicates **Kenwood's** voluntary participation in an industry program to collect and recycle Li-ion batteries after their operating life has expired. The RBRC program is an alternative to disposing Li-ion batteries with your regular refuse or in municipal waste streams, which is illegal in some areas.

For information on Li-ion battery recycling in your area, call (toll free) 1-800-8-BATTERY (1-800-822-8837).

Kenwood's involvement in this program is part of our commitment to preserve our environment and conserve our natural resources.

This product contains a CR Coin Cell Lithium Battery which contains Perchlorate Material – special handling may apply.

See www.dtsc.ca.gov/hazardouswaste/perchlorate

PRECAUTIONS

- Do not charge the transceiver and battery pack when they are wet.
- Ensure that there are no metallic items located between the transceiver and the battery pack.
- Do not use options not specified by **Kenwood**.
- If the die-cast chassis or other transceiver part is damaged, do not touch the damaged parts.
- If a headset or headphone is connected to the transceiver, reduce the transceiver volume. Pay attention to the volume level when turning the squelch off.
- Do not place the microphone cable around your neck while near machinery that may catch the cable.
- Do not place the transceiver on unstable surfaces.
- Ensure that the end of the antenna does not touch your eyes.
- When the transceiver is used for transmission for many hours, the radiator and chassis will become hot. Do not touch these locations when replacing the battery pack.
- Do not immerse the transceiver in water.
- Always switch the transceiver power off before installing optional accessories.
- For safety reasons, we recommend that the AC adapter (for the battery charger) be connected to an easily accessible AC socket.



WARNING

Turn the transceiver power off in the following locations:

- In explosive atmospheres (inflammable gas, dust particles, metallic powders, grain powders, etc.).
- While taking on fuel or while parked at gasoline service stations.
- Near explosives or blasting sites.
- In aircrafts. (Any use of the transceiver must follow the instructions and regulations provided by the airline crew.)
- Where restrictions or warnings are posted regarding the use of radio devices, including but not limited to medical facilities.
- Near persons using pacemakers.



CAUTION

- Do not disassemble or modify the transceiver for any reason.
- Do not place the transceiver on or near airbag equipment while the vehicle is running. When the airbag inflates, the transceiver may be ejected and strike the driver or passengers.
- Do not transmit while touching the antenna terminal or if any metallic parts are exposed from the antenna covering. Transmitting at such a time may result in a high-frequency burn.
- If an abnormal odor or smoke is detected coming from the transceiver, switch the transceiver power off immediately, remove the battery pack from the transceiver, and contact your **Kenwood** dealer.
- Use of the transceiver while you are driving may be against traffic laws. Please check and observe the vehicle regulations in your area.
- Do not expose the transceiver to extremely hot or cold conditions.



- Do not carry the battery pack (or battery case) with metal objects, as they may short the battery terminals.
- When operating the transceiver in areas where the air is dry, it is easy to build up an electric charge (static electricity). When using a earphone accessory in such conditions, it is possible for the transceiver to send an electric shock through the earphone and to your ear. We recommend you use only a speaker/microphone in these conditions, to avoid electric shocks.
- Do not swing the transceiver around while holding onto the strap. Doing so may cause injury to other persons and damage to the transceiver.

Information concerning the battery pack:

The battery pack includes flammable objects such as organic solvent. Mishandling may cause the battery to rupture producing flames or extreme heat, deteriorate, or cause other forms of damage to the battery. Please observe the following prohibitive matters.



- **Do not disassemble or reconstruct battery!**
The battery pack has a safety function and protection circuit to avoid danger. If they suffer serious damage, the battery may generate heat or smoke, rupture, or burst into flame.
- **Do not short-circuit the battery!**
Do not join the + and – terminals using any form of metal (such as a paper clip or wire). Do not carry or store the battery pack in containers holding metal objects (such as wires, chain-necklace or hairpins). If the battery pack is short-circuited, excessive current will flow and the battery may generate heat or smoke, rupture, or burst into flame. It will also cause metal objects to heat up.
- **Do not incinerate or apply heat to the battery!**
If the insulator is melted, the gas release vent or safety function is damaged, or the electrolyte is ignited, the battery may generate heat or smoke, rupture, or burst into flame.
- **Do not leave the battery near fire, stoves, or other heat generators (areas reaching over 80°C/ 176°F)!**
If the polymer separator is melted due to high temperature, an internal short-circuit may occur in the individual cells and the battery may generate heat or smoke, rupture, or burst into flame.
- **Do not immerse the battery in water or get it wet by other means!**
If the battery's protection circuit is damaged, the battery may charge at extreme current (or voltage) and an abnormal chemical reaction may occur. The battery may generate heat or smoke, rupture, or burst into flame.
- **Do not charge the battery near fire or under direct sunlight!**
If the battery's protection circuit is damaged, the battery may charge at extreme current (or voltage) and an abnormal chemical reaction may occur. The battery may generate heat or smoke, rupture, or burst into flame.
- **Use only the specified charger and observe charging requirements!**
If the battery is charged in unspecified conditions (under high temperature over the regulated value, excessive high voltage or current over regulated value, or with a remodeled charger), it may overcharge or an abnormal chemical reaction may occur. The battery may generate heat or smoke, rupture, or burst into flame.

**DANGER**

- **Do not pierce the battery with any object, strike it with an instrument, or step on it!**
This may break or deform the battery, causing a short-circuit. The battery may generate heat or smoke, rupture, or burst into flame.
- **Do not jar or throw the battery!**
An impact may cause the battery to leak, generate heat or smoke, rupture, and/or burst into flame. If the battery's protection circuit is damaged, the battery may charge at an abnormal current (or voltage), and an abnormal chemical reaction may occur. The battery may generate heat or smoke, rupture, or burst into flame.
- **Do not use the battery pack if it is damaged in any way!**
The battery may generate heat or smoke, rupture, or burst into flame.
- **Do not solder directly onto the battery!**
If the insulator is melted or the gas release vent or safety function is damaged, the battery may generate heat or smoke, rupture, or burst into flame.
- **Do not reverse the battery polarity (and terminals)!**
When charging a reversed battery, an abnormal chemical reaction may occur. In some cases, an unexpected large amount of current may flow upon discharging. The battery may generate heat or smoke, rupture, or burst into flame.
- **Do not reverse-charge or reverse-connect the battery!**
The battery pack has positive and negative poles. If the battery pack does not smoothly connect with a charger or operating equipment, do not force it; check the polarity of the battery. If the battery pack is reverse-connected to the charger, it will be reverse-charged and an abnormal chemical reaction may occur. The battery may generate heat or smoke, rupture, or burst into flame.
- **Do not touch a ruptured and leaking battery!**
If the electrolyte liquid from the battery gets into your eyes, wash your eyes with fresh water as soon as possible, without rubbing your eyes. Go to the hospital immediately. If left untreated, it may cause eye-problems.

**WARNING**

- **Do not charge the battery for longer than the specified time!**
If the battery pack has not finished charging even after the regulated time has passed, stop it. The battery may generate heat or smoke, rupture, or burst into flame.
- **Do not place the battery pack into a microwave or high pressure container!**
The battery may generate heat or smoke, rupture, or burst into flame.
- **Keep ruptured and leaking battery packs away from fire!**
If the battery pack is leaking (or the battery emits a bad odor), immediately remove it from flammable areas. Electrolyte leaking from battery can easily catch on fire and may cause the battery to generate smoke or burst into flame.
- **Do not use an abnormal battery!**
If the battery pack emits a bad odour, appears to have different coloring, is deformed, or seems abnormal for any other reason, remove it from the charger or operating equipment and do not use it. The battery may generate heat or smoke, rupture, or burst into flame.

CONTENTS

PREPARATION.....	1
SUPPLIED ACCESSORIES	1
INSTALLING THE ANTENNA.....	1
INSTALLING THE BATTERY PACK	2
INSTALLING ALKALINE BATTERIES.....	2
INSTALLING THE BELT CLIP.....	3
CHARGING THE PB-45L BATTERY PACK	4
BATTERY LIFE.....	5
CONNECTING TO A CIGARETTE LIGHTER SOCKET	6
CONNECTING TO A REGULATED POWER SUPPLY.....	7
CONNECTING TO A PC	7
GETTING ACQUAINTED	8
KEY AND CONTROL KNOB OPERATIONS.....	8
DISPLAY.....	12
BASIC OPERATIONS	14
SWITCHING THE POWER ON/ OFF	14
ADJUSTING THE VOLUME	14
ADJUSTING THE SQUELCH	15
SELECTING AN OPERATION BAND	15
SELECTING DUAL BAND MODE/ SINGLE BAND MODE	16
SELECTING A FREQUENCY BAND.....	16
SELECTING AN OPERATING MODE.....	17
FREQUENCY DIRECT ENTRY.....	19
TRANSMITTING	20
BACKLIGHT	21
MONITOR.....	21
SETUP OPERATION.....	22
MENU MODE	23
MENU MODE	23
MENU ACCESS	23
MENU CONFIGURATION	24
CHARACTER ENTRY	33
OPTIONS	35
MEMORY CONTROL PROGRAM MCP-4A	35
MAINTENANCE	36
GENERAL INFORMATION.....	36
SERVICE	36
SERVICE NOTE	36
CLEANING	36
TROUBLESHOOTING.....	37
SPECIFICATIONS.....	41

For a detailed explanation on transceiver operation, refer to the PDF file supplied on the CD-ROM.

Operation	File name (TH-D72_)
CONTENTS	00_CONTENTS_E.pdf
OPERATING THROUGH REPEATERS	01_REPEATER_E.pdf
MEMORY CHANNELS	02_MEMORY CHANNEL_E.pdf
SCAN	03_SCAN_E.pdf
CTSSS/ DCS/ CROSS TONE	04_CTCSS_DCS_CROSS TONE_E.pdf
DUAL TONE MULTI-FREQUENCY (DTMF)	05_DTMF_E.pdf
EchoLink®	06_EchoLink_E.pdf
OTHER OPERATIONS	07_OTHER OPERATIONS_E.pdf
GPS	08_GPS_E.pdf
PACKET	09_PACKET_E.pdf
APRS®	10_APRS_E.pdf
TRANSCEIVER RESET	11_RESET_E.pdf
SKY COMMAND II	12_SKY COMMAND_E.pdf
WEATHER ALERT (TH-D72A ONLY)	13_WEATHER ALERT_TH-D72A_E.pdf
WIRELESS REMOTE (TH-D72A ONLY)	14_WIRELESS_TH-D72A_E.pdf

Note: The Operations file is available in PDF file format. To read the file, you must use Adobe® Reader®.

PREPARATION

SUPPLIED ACCESSORIES

After carefully unpacking the transceiver, identify the items listed in the table below. We recommend you keep the box and packaging for shipping.

Item	Comments	Quantity	
		TH-D72A	TH-D72E
Antenna		1	1
Li-ion battery pack	PB-45L: 1800 mAh	1	1
Wall charger		1	1
AC power cable	for the wall charger	–	2
Belt hook		1	1
USB cable	A - Mini B type	1	1
Warranty card		1	1
Instruction manual	English/ French/ Spanish	1	1
	Italian/ German/ Dutch	–	1
CD-ROM	For a detailed explanation on transceiver operations	1	1

INSTALLING THE ANTENNA

Hold the supplied antenna by its base, then screw it into the connector on the top panel of the transceiver until secure.

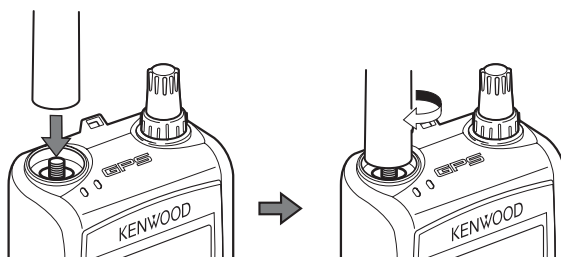

INSTALLING THE BATTERY PACK

Note: Because the battery pack is provided uncharged, you must charge the battery pack before using it with the transceiver. To charge the battery pack, refer to “CHARGING THE PB-45L BATTERY PACK” (page 4).

- 1 Unlock (open) the safety catch located at the bottom of the battery pack.
- 2 Match the guides of the battery pack with the corresponding grooves on the upper rear of the transceiver, then firmly press the battery case to lock it in place.

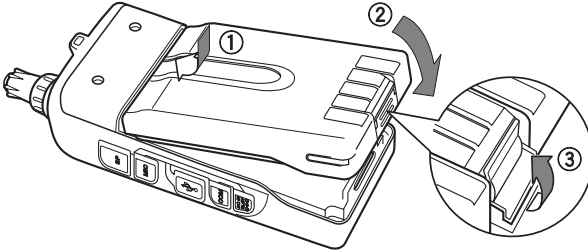

- 3 Flip the safety catch into place to prevent accidentally pressing the release latch and removing the battery pack.
- 4 To remove the battery pack, lift the safety catch, then press the release latch to unlock the battery pack. Lift the battery pack away from the transceiver.

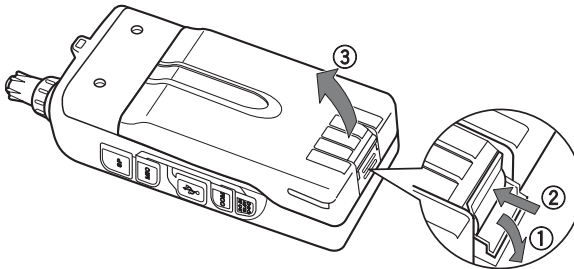

INSTALLING ALKALINE BATTERIES

- 1 To open the optional BT-15 battery case lid, press the release lever on the top of the battery case, then pull the cover up.

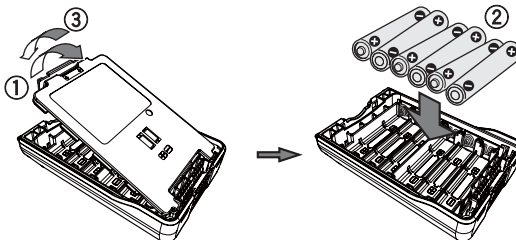

- 2 Insert (or remove) six AAA (LR03) Alkaline batteries.
 - When removing the Alkaline batteries from the battery case, pull up on the batteries from the positive (+) terminal.

- Be sure to match the battery polarities with those marked in the bottom of the battery case.
- 3 Align the two tabs at the bottom of battery case, then close the cover until the locking tabs on top click.
 - 4 To install the battery case onto (or remove it from) the transceiver, follow steps 1 to 3 of "INSTALLING THE BATTERY PACK".
 - When using the BT-15, set the "Battery Type" to "Alkaline", in Menu No. 112 (page 24). If it is set to "Lithium", the battery capacity indicator (page 22) will not show the correct initial value. When using the battery pack, return the setting to "Lithium".

Note:

- ◆ When carrying the battery case while using a battery pack, place the battery case in the BT-15 carrying pouch.
 - ◆ Do not use Manganese batteries or Rechargeable batteries in place of Alkaline batteries.
 - ◆ Remove all batteries from the case when it is not expected to be in use for several months.
 - ◆ To lift the battery pack safety catch, use a piece of hardened plastic or metal, such as a screwdriver, that is no more than 6 mm wide and 1 mm thick. It is imperative that you place the implement under only the lip of the safety catch so that you do not damage the release latch.
-

INSTALLING THE BELT CLIP

If desired, you can install the supplied belt clip to the transceiver.

- 1 Loosely insert the two supplied screws into the holes on the back panel of the transceiver.

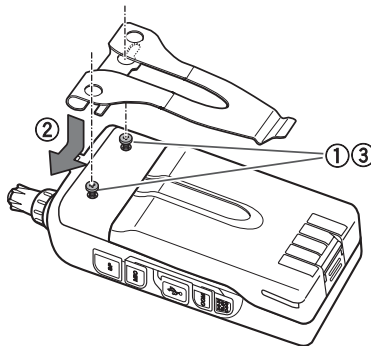

- 2 Slide the belt hook into position, under the screws.
- 3 Tighten the screws until secure.

Note: When the belt hook is not attached to the transceiver, remove the screws from the transceiver to avoid scratching other materials.

CHARGING THE PB-45L BATTERY PACK

The battery pack can be charged after it has been installed onto the transceiver. (The battery pack is provided uncharged for safety purposes.)

- 1 Confirm that the transceiver power is OFF.
 - While charging the battery pack, leave the transceiver power OFF.
- 2 Insert the charger plug into the DC IN jack of the transceiver.

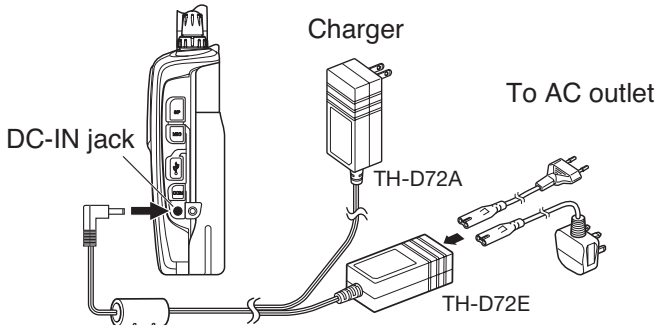

- 3 Plug the charger into an AC wall outlet.
 - Charging starts and the two TX-RX LEDs on the top panel light orange.
- 4 It takes approximately 8 hours to charge an empty PB-45L Li-ion battery pack. After 8 hours, remove the charger plug from the transceiver DC-IN jack.
 - When charging completes, the LEDs turn off.
- 5 Unplug the charger from the AC wall outlet.

Note:

- ◆ Never leave the battery pack in direct sunlight.
- ◆ The transceiver becomes warm while charging the battery pack.
- ◆ While the battery pack is charged, the ambient temperature must be within 0°C ~ 40°C (32°F ~ 104°F). Otherwise, charging does not start. If the transceiver senses that the temperature is more than 60°C (140° F) during charging, the transceiver stops charging.
- ◆ Before recharging the battery pack, use the battery pack until the transceiver stops receiving.
- ◆ Do not plug the charger into the DC IN jack for more than 24 hours.
- ◆ Unplug the charger as soon as possible after the charging period is over.
- ◆ After the battery pack is charged, do not unplug and plug the charger into the AC outlet again. Unplugging the charger will reset the charging timer and the battery pack will be charged again. This could result in over-charging.
- ◆ If the battery pack is recharged repeatedly before the battery pack is not fully used, the memory effect (the battery pack will not allow the charger to recharge the battery to more than a certain voltage level) may occur. In this case, turn the transceiver ON until it stops receiving in order to discharge the battery pack, then recharge the battery pack as normal.
- ◆ When the battery is installed on the transceiver and you are using an optional rapid battery charger, do not charge the battery from the DC-IN Jack. Charging the battery from the DC-IN Jack may result in overcharging the battery which can result in the shortening of the battery life cycle.
- ◆ If the battery pack is not used for a long time, the battery pack capacity temporarily decreases. In this case, charge the battery and use the battery pack until the transceiver stops receiving. Repeat this procedure several times. The battery pack should recover its capacity.
- ◆ If the charger is plugged into the DC IN jack before the battery pack is attached, turn the transceiver power ON and then OFF again to initiate charging.

- ◆ Exceeding the specified charge period shortens the useful life of the PB-45L battery pack.
- ◆ The provided charger is designed to charge only the PB-45L battery pack. Charging other models of battery packs may damage the charger and battery pack.
- ◆ Do not transmit while charging.
- ◆ When not in use, store the battery pack in a cool and dry place.
- ◆ Before charging the battery pack, ensure that the safety catch is firmly closed.
- ◆ Attention should be drawn to the environmental aspects of battery disposal.
- ◆ It takes approximately 3 hours to charge the PB-45L with the optional KSC-32.

Charger Error

- While charging, if a problem is detected in the battery, the LED will light or a beep will sound, to indicate the problem.
- If a charging error occurs when the power is turned on, charging is cancelled, a beep sounds, and “Charge Error” appears on the display.
- If a charging error occurs when the power is turned off, charging is cancelled and the TX-RX LED flashes orange.
- The following conditions create charging errors:
 - A short in the battery is detected.
 - Overvoltage in the battery is detected.
 - The charge timer is exceeded (the battery has deteriorated).
- When a charge error occurs, no key other than [⏻] will function.

BATTERY LIFE

Before you operate the transceiver outside using a battery pack, it is important to know how long the battery pack will last. The operating times listed in the table below are measured under the following cyclic conditions:

TX: 6 seconds, RX: 6 seconds, Stand-by: 48 seconds

We recommend you carry extra battery packs with you, in case the battery pack becomes depleted.

Battery Type	Output Power	Operating Time/ Hours (Approx.)
PB-45L (7.4 V)	H	6
	L	12
	EL	15
BT-15 (9 V)	H	1.5
	L	6
	EL	8

Note: Internal resistance levels differ, depending on the battery, so when using Alkaline batteries there are times when the actual operating time may be shorter than normal.

CONNECTING TO A CIGARETTE LIGHTER SOCKET

To connect the transceiver to the cigarette lighter socket in your vehicle, use an optional PG-3J Cigarette Lighter cable.

When the PG-3J is connected to the cigarette lighter plug, the transceiver automatically starts charging the PB-45L battery pack. While you operate the transceiver, it charges the PB-45L battery pack in the background.



CAUTION

To connect with an external 24 V power source via a DC-DC converter, only use the optional PG-3J Cigarette Lighter cable.

Using the PG-2W DC cable in this situation may cause a fire.

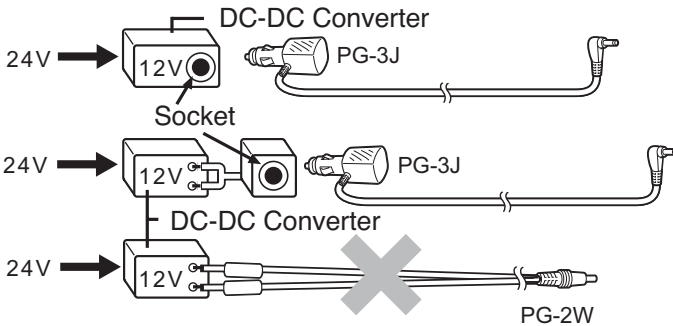

Note:

- ◆ Do not use the PG-2W to connect directly to a vehicle battery (12 V). Extensive voltage could result in damaging the transceiver.
- ◆ If the input voltage exceeds approximately 17.5 V, the transceiver automatically turns OFF.

CONNECTING TO A REGULATED POWER SUPPLY

To connect the transceiver to an appropriate regulated DC power supply, use an optional PG-2W DC cable.

- 1 Confirm that the power of both the transceiver and the DC power supply is OFF.
- 2 Connect the optional PG-2W DC cable to the DC power supply; the red lead to the positive (+) terminal, and the black lead to the negative (-) terminal.

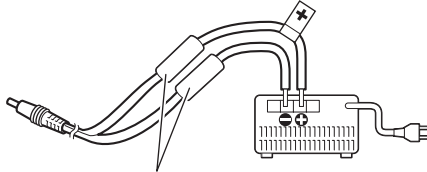

Fuses (3 A)

- 3 Connect the barrel plug on the DC cable to the DC IN jack of the transceiver.
 - While a DC power supply is connected with the DC IN jack, the transceiver automatically initiates charging the PB-45L battery pack.

Note:

- ◆ If the DC power supply voltage is below 12.0 V DC, you may not be able to charge the PB-45L battery pack.
 - ◆ The supply voltage must be between 12.0 V and 16.0 V to prevent damaging the transceiver. If the input voltage exceeds approximately 17.5 V, the transceiver automatically turns OFF.
-

CONNECTING TO A PC

The USB connector allows you to directly connect to a computer by using a supplied USB cable.

- Download the virtual COM port driver from the URL listed below.

http://www.kenwood.com/i/products/info/amateur/software_download.html

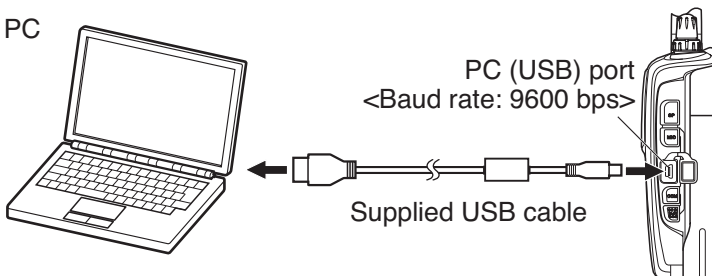

Depending on the usage condition of the USB apparatus, saved content may be lost. Kenwood does not take responsibility for damages or lost content.

GETTING ACQUAINTED

KEY AND CONTROL KNOB OPERATIONS

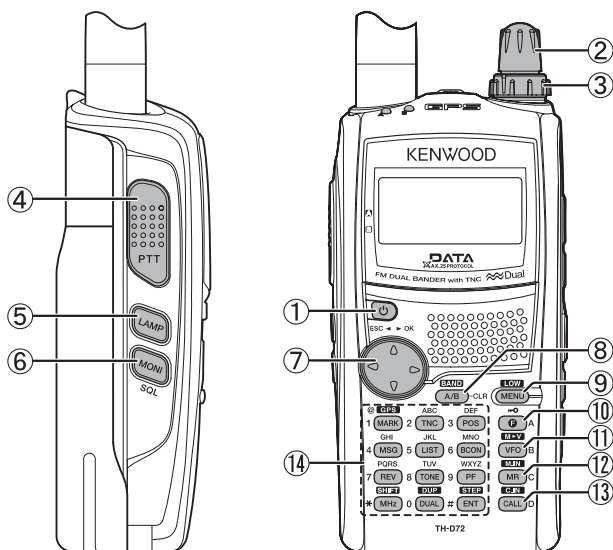

① [P] Power

Press [P] to turn the transceiver power ON and OFF.

② Tuning Control

Rotate the **Tuning** control to select an operating frequency, Memory channel, Menu number, setting value and change the scan direction, etc.

③ VOL Control

Rotate the **VOL** control to adjust the speaker volume.

④ [PTT]

Press and hold [PTT], then speak into the microphone to transmit.

⑤ [LAMP]

Press [LAMP] to illuminate the display and keys.

Press [F], [LAMP] to keep the light ON continuously.

⑥ [MONI]

Press and hold [MONI] to unmute the speaker in order to monitor signals. Release [MONI] to return to normal operation.

Press [F], [MONI] to enter the Squelch level adjustment mode.

⑦ **[▲], [▼]**

Press **[▲]** or **[▼]** to select an operating frequency, Memory channel, Menu number, setting value or to change the scan direction, etc.

The **[▲]/[▼]** keys function in the exact same way as the **Tuning** control. These keys change frequencies, memory channels, or other selections, depending on the current transceiver mode.

[▶ OK]

Press **[▶ OK]** to move to the next step or to complete the setting in various selection modes such as Function Select or Menu mode.

[ESC ◀]

Press **[ESC ◀]** to move back to the previous step or to quit the setting in various selection modes such as Function Select or Menu mode.

⑧ **[A/B]**

Press **[A/B]** to select operation band A or B.

Press **[F], [A/B]** to select a frequency band.

⑨ **[MENU]**

Press **[MENU]** to enter Menu mode.

Press **[F], [MENU]** to cycle the transmit output power between: High Power → Low Power → Economic Low Power.

⑩ **[F]**

Press **[F]** to enter Function mode.

Press **[F] (1s)** to turn the transceiver key lock function ON and OFF.

⑪ **[VFO]**

Press **[VFO]** to enter VFO mode, then press **[▲]/[▼]** or rotate the **Tuning** control to select an operating frequency.

Press **[F], [VFO]** to copy the current Memory channel or Call channel to the VFO (memory shift).

⑫ **[MR]**

Press **[MR]** to enter Memory Channel mode, then press **[▲]/[▼]** or rotate the **Tuning** control to select a Memory channel.

Select a Memory channel, then press **[F], [MR]** to store the current operating frequency in the Memory channel.

⑬ **[CALL]**

Press **[CALL]** to select the Call channel.

Press **[F], [CALL]** to store the current operating frequency to the Call channel.

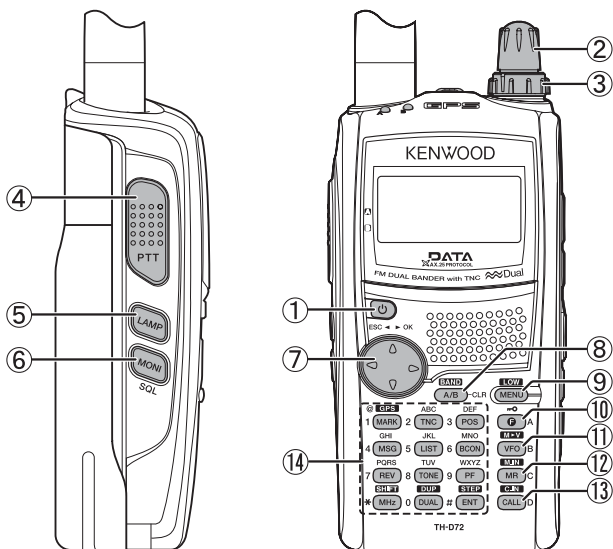

⑭ 12 Keypad

[MARK] (1)

Press **[MARK]** to display the Mark Way point list.

Press **[MARK] (1s)** to enter the Mark Way point registration mode.

Press **[F], [MARK]** to turn the internal GPS function ON or OFF.

[TNC] (2)

Press **[TNC]** to turn the built-in TNC ON and the APRS (or NAVITRA) mode ON.

- Each time you press **[TNC]**, the mode cycles through the following: APRS (or NAVITRA) mode ON ⇒ PACKET mode ON ⇒ TNC OFF.
- When the built-in TNC turns on, “OPENING TNC” appears on the display.
- During “OPENING TNC” appears on the display, the mode cannot be changed.

Press **[F], [TNC]** to turn the Tracking Log function ON or OFF.

[POS] (3)

Press **[POS]** to display your “My position” (using the internal GPS) or to enter the Position registration mode (not using the internal GPS) <APRS>.

Press **[F], [POS]** to enter the My Weather mode <APRS>.

[MSG] (4)

Press **[MSG]** to display the Message list.

Press **[F], [MSG]** to enter the New Message input mode <APRS>.

[LIST] (5)

Press **[LIST]** to display the Station list.

Press **[F]**, **[LIST]** to display the DX Cluster list **<APRS>**.

[BCON] (6)

Press **[BCON]** to enter the Beacon Transmit mode (When TX Beacon method is Manual) or turn the Beacon function ON or OFF (When TX Beacon method is other than Manual) **<APRS>**.

Press **[F]**, **[BCON]** to enter the Quick Beacon mode **<APRS>**.

[REV] (7)

Press **[REV]** to turn the Reverse function ON or OFF.

Press **[REV] (1s)** to turn the Automatic Simplex Checker ON.

Press **[F]**, **[REV]** to enter the Voice Alert function setup mode **<APRS>**.

[TONE] (8)

Press **[TONE]** to turn the Tone function ON.

- Each time you press **[TONE]**, the function cycles through the following: Tone ON ➔ CTCSS ON ➔ DCS ON ➔ Cross Tone ON ➔ OFF.
- Additionally, when APRS is ON and Voice Alert is configured, Voice Alert ON is added to the above cycle.

Press **[F]**, **[TONE]** to enter the Tone frequency, CTCSS frequency, DCS code, or Cross Tone setup mode.

Press **[F]**, **[TONE] (1s)** to start the Tone frequency ID, CTCSS frequency ID, or DCS code ID scan.

[PF] (9)

Press **[PF]** to activate its programmed function. The default function is “Weather Channel” (TH-D72A)/ “Memory Name < > Frequency” (TH-D72E).

[MHz] (✖)

Press **[MHz]** to enter the MHz mode.

Press **[MHz] (1s)** to start the MHz scan.

Press **[F]**, **[MHz]** to enter Offset Direction setup mode.

- Each time you press **[F]**, **[MHz]**, the offset direction cycles through the following: plus (+) direction ➔ minus (-) direction ➔ -7.6 MHz (TH-D72E only) ➔ OFF.

[DUAL] (0)

Press **[DUAL]** to switch the Single band mode and Dual band mode.

Press **[F]**, **[DUAL]** to turn the Full duplex function ON or OFF.

[ENT] (#)







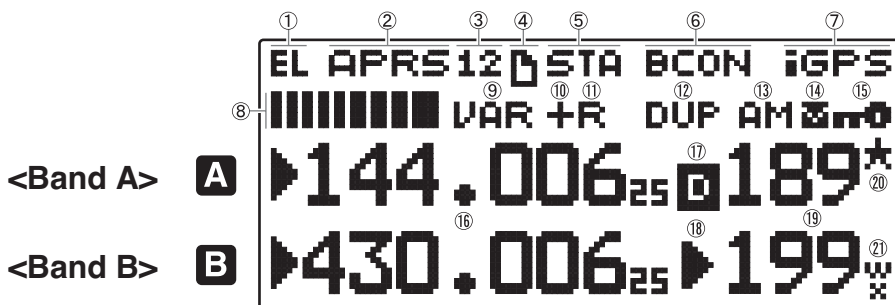

Press **[ENT]** to enter Frequency or Channel number entry mode.

Press **[F]**, **[ENT]** to enter Frequency step setup mode.

DISPLAY



Indicator		Description
①	EL	Appears while using Economic low output power.
	L	Appears while using Low output power.
	H	Appears while using High output power.
②	APRS	Appears when the Beacon type is set to “APRS”.
	NAVITRA	Appears when the Beacon type is set to “NAVITRA”.
	PACKET	Appears while using Packet mode.
③	12	Appears when the packet transfer rate is set to 1200 bps.
	96	Appears when the packet transfer rate is set to 9600 bps.
④	D	Appears when a message is received.
⑤	STA	Appears while in Stand-by (Packet mode)
⑥	CON	Appears while Connected (Packet mode)
	BCON	Appears when the Beacon function is ON.
⑦	GPS	Appears when the external GPS is ON. Blinks while positioning.
	iGPS	Appears when the internal GPS is ON. Blinks while positioning.
	iZZ	Appears while the internal GPS save mode is activated.
	iLOG	Appears when the Track Log is ON.
	WXI	Appears when the Weather Instrument is ON.
	iG&W	Appears when the internal GPS and Weather Instrument is ON.
⑧	■■■■■■■	Performs as an S meter when receiving a signal and displays the selected power level while transmitting.

Indicator		Description
⑨		Appears when the Tone function is ON.
	CT	Appears when the CTCSS function is ON.
	DCS	Appears when the DCS function is ON.
	T/C	Appears when the Cross tone setting is “TONE/CTCSS”.
	D/C	Appears when the Cross tone setting is “DCS/CTCSS”.
	T/D	Appears when the Cross tone setting is “TONE/DCS”.
	D/O	Appears when the Cross tone setting is “DCS/Off”.
	VA	Appears when Voice Alert is set to “On”.
	VAR	Appears when Voice Alert is set to “RX Only”.
⑩	+	Appears when the Shift function is set to plus.
	-	Appears when the Shift function is set to minus.
	=	Appears when the Shift function is set to -7.6 MHz.
⑪	R	Appears when the Reverse function is ON.
		Appears when the ASC function is ON. Blinks when the ASC function is performing an OK check.
⑫	DUP	Appears while in Full Duplex mode.
⑬	AM	Appears while in AM mode.
		Appears while in Narrow FM mode.
⑭		Appears when the VOX function is ON.
⑮		Appears when the Key Lock function is ON.
⑯	144.006₂₅	Displays the operating frequency.
⑰		Appears while using the Internal data band.
⑱		Appears when the selected channel is not registered while in Memory Input mode.
		Appears when the selected channel is registered while in Memory Input mode.
⑲	189	Displays the Memory channel number.
⑳	★	Appears when the Memory Channel Lockout function is ON.
㉑		Appears when Weather Alert is ON. Blinks when receiving a signal. (TH-D72A only)

BASIC OPERATIONS

SWITCHING THE POWER ON/ OFF

Press the **[PWR]** (**1s**) to switch the transceiver ON.

- The power on message momentarily appears on the display.

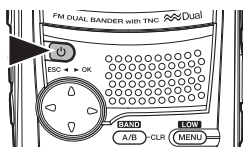

- If the transceiver power on password has been activated {Menu No.100}, you must first enter your password before you can operate the transceiver.

Press the **[PWR]** (**1s**) again to switch the transceiver OFF.

Note: While using APRS, in order to prevent Packet miss-decoding, access Menu No. 110 and set the Battery Saver to "Off" or "0.03".

ADJUSTING THE VOLUME

Rotate the **VOL** control to increase the volume and counterclockwise to decrease the volume.

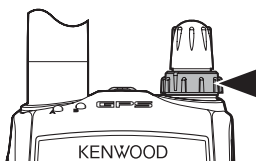

Note:

- ◆ Some functions of this transceiver, such as the beep, have their own volume settings. Adjust those settings to your desired values.
- ◆ Access Menu No. 121 to set the volume balance between Band A and B.

ADJUSTING THE SQUELCH

Squelch is used to mute the speaker when no signals are present. With the squelch level set correctly, you will hear sound only while actually receiving a signal. The higher the squelch level selected, the stronger the signals must be in order to hear them. You can set the squelch level separately for Band A and B.

1 Press [F], [MONI].

- The squelch level appears on the display.

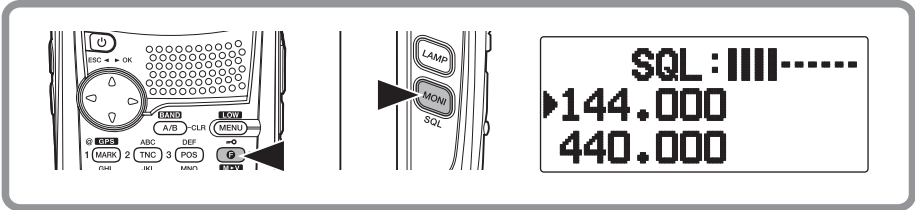

2 Press [▲]/[▼] or rotate the **Tuning** control of your selected band, when no signals are present, and select the squelch level at which the background noise is just eliminated.

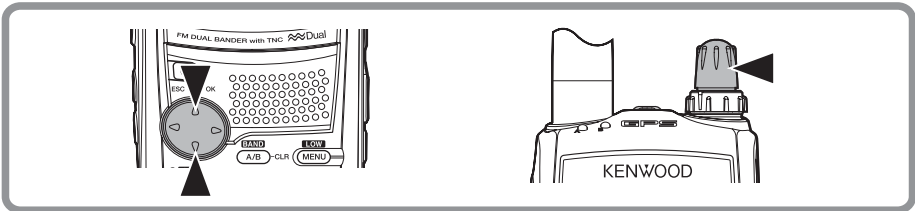

SELECTING AN OPERATION BAND

Press [A/B] to select operating band A or B.

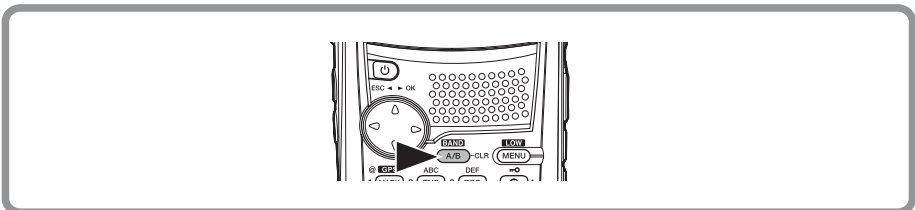

SELECTING DUAL BAND MODE/ SINGLE BAND MODE

You can switch the transceiver between dual band operation and single band operation.

- 1 Select your desired band (A or B).
- 2 Press **[DUAL]**.
 - Each time you press **[DUAL]**, the transceiver switches between Single band mode and Dual band mode.

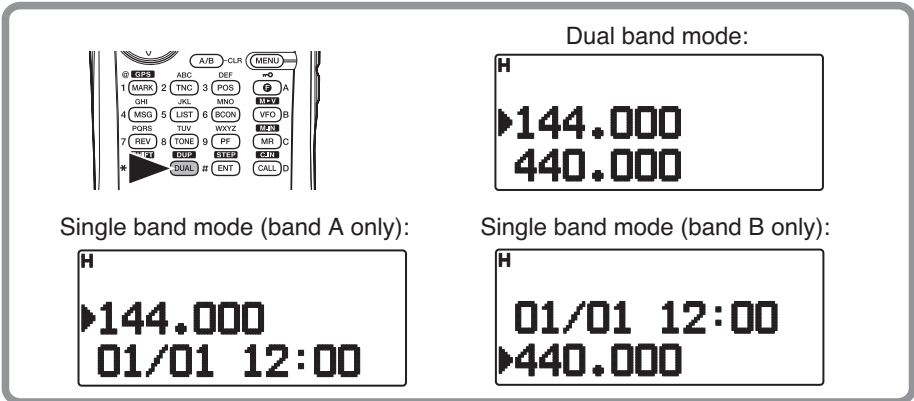

SELECTING A FREQUENCY BAND

You can change the frequency bands for bands A and B.

- 1 Select your desired band (A or B).
- 2 Press **[F]**, **[A/B]**.

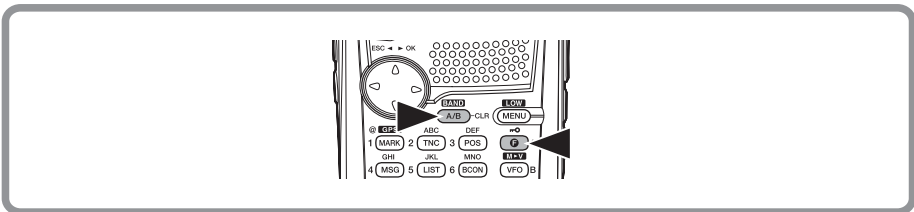

- Each time you press **[F]**, **[A/B]**, you cycle to the next frequency band.
 - Band A: 144 ⇒ 430/440 ⇒ 144 (MHz).
 - Band B: 118 ⇒ 144 ⇒ 300 ⇒ 430/440 ⇒ 118 (MHz).

Note: The TH-D72E uses the 430 MHz band and the TH-D72A uses the 440 MHz band.

- When masking a band, you are restricted to using only the selectable band.
- When receiving 2 signals on the same band, the image interference, sensitivity, etc., performance will decrease.

Frequency ranges:

- 118 MHz: Band B 118 ~ 135.995 MHz
- 144 MHz: 136 ~ 173.995 MHz
- 300 MHz: Band B 320 ~ 399.995 MHz
- 430/440 MHz: Band A 410 ~ 470 MHz, Band B 400 ~ 523.995 MHz

SELECTING AN OPERATING MODE

There are 3 operating modes available to choose from: VFO mode, Memory Channel mode, and Call Channel mode.

VFO Mode

VFO mode allows you to manually change the operating frequency.

- 1 Press **[VFO]** to enter VFO mode.
- 2 Rotate the **Tuning** control to select your desired operating frequency.

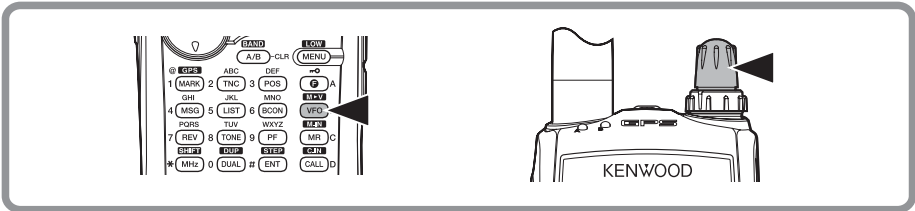

- You can also select a frequency by using the **[▲]/[▼]** keys.
- The default step frequency for the **Tuning** control varies according to the model and operating band:

Model	144 MHz	430/440 MHz
TH-D72A	5 kHz	25 kHz
TH-D72E	12.5 kHz	25 kHz

- To adjust the frequency by a larger amount, press **[MHz]** to enter MHz mode, then rotate the **Tuning** control to adjust the frequency in steps of 1 MHz. Press **[MHz]** again to exit MHz mode and adjust the frequency using the normal step frequency.

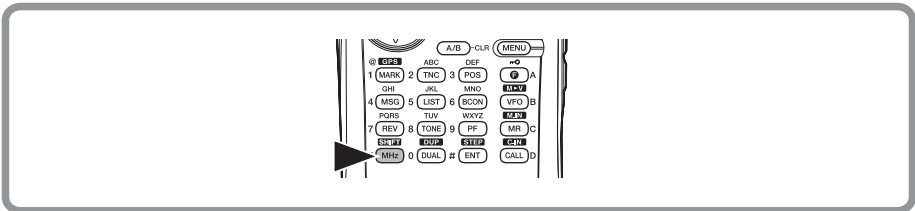

Memory Channel Mode

Memory Channel mode allows you to quickly select a frequently used frequency and related data which you have stored in the memory channel.

- 1 Press **[MR]** to enter Memory Channel mode.
 - The Memory channel number appears on the display.

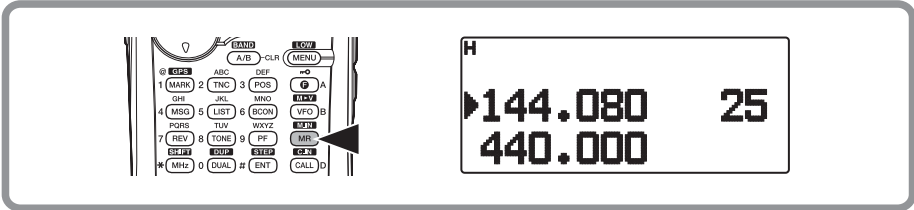

- 2 Rotate the **Tuning** control to select your desired Memory channel.

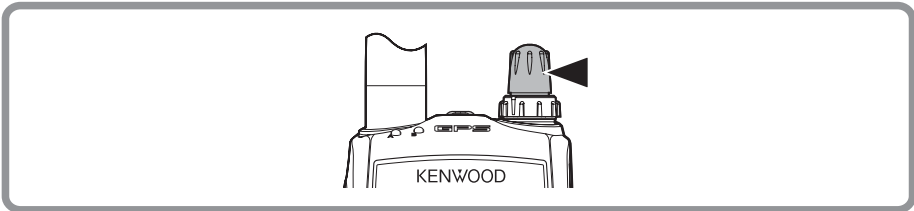

- You can also select a Memory channel by using the **[▲]/[▼]** keys.

Call Channel Mode

Call Channel mode allows you to quickly select a preset channel to allow immediate calls on that frequency. The Call channel can be conveniently used as an emergency channel within your group.

- 1 Press **[CALL]** to enter Call Channel mode.
 - “C” appears on the display.
 - If the frequency of the operating band is less than 300 MHz, the VHF CALL channel is used for recall. If the frequency is over 300 MHz, the UHF CALL channel is used for recall.

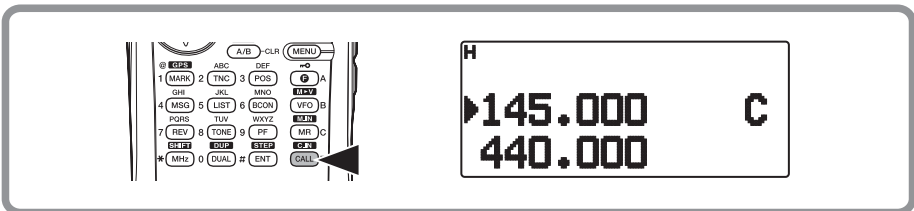

- 2 Press **[CALL]** again, the transceiver will return to the previous status (VFO mode or Memory Channel mode) before entering CALL mode.

FREQUENCY DIRECT ENTRY

If the desired operating frequency is far from the current frequency, using the keypad is the quickest way to change the frequency.

- 1 Press **[A/B]** to select band A or B, then press **[VFO]** or **[CALL]**.
- 2 Press **[ENT]**.
 - The Direct Frequency Entry display appears.

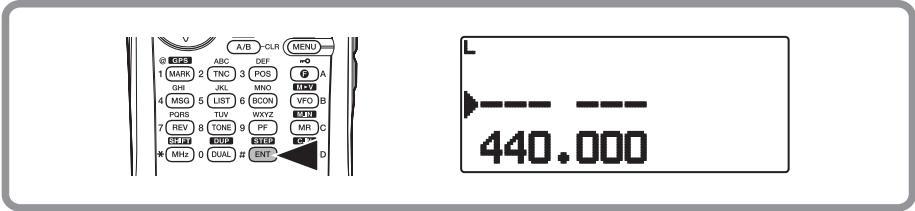

- 3 Press the numeric keys (**[0]** ~ **[9]**) to enter your desired frequency.
- 4 To set the entered frequency, press **[ENT]** or **[VFO]**.
 - Pressing **[ENT]** before entering all of the digits will set the remaining digits to 0.
 - Pressing **[VFO]** before entering all of the digits will leave the remaining digits at their previous values.
 - Entering all digits for a frequency will automatically set the frequency without pressing **[ENT]** or **[VFO]**.
 - In step 3, after entering 1 ~ 3 digits, pressing **[MHz]** will set the digits above the MHz value.

For example, when the displayed current frequency is 432.250:

- 1 Press **[ENT]** ⇒ --- ---
- 2 Press **[4]** ⇒ 4 --- ---
- 3 Press **[MHz]** ⇒ 4 3 4. ---

TRANSMITTING

- 1 Select your desired band and frequency/channel.
- 2 Press and hold the microphone **[PTT]** switch and speak into the microphone to transmit.
 - The TX-RX LED lights red for the selected transmit band and the RF power meter appears on the display. The RF power meter shows the relative transmission output power you selected.

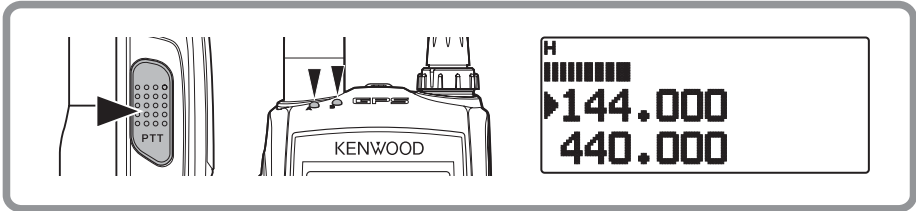

- “H”, “L”, or “EL” appear on the display, depending on the output power you have selected.
 - Speak into the microphone in your normal voice, while keeping the microphone approximately 5 cm (2 inches) from your mouth. Speaking too close to the microphone or too loudly may increase distortion and reduce intelligibility of your signal at the receiving station.
 - Your station’s transmit signal can be received when the receive frequency is 3 times the transmit frequency.
Example: Transmit frequency is 146.000 MHz and receive frequency is 438.000 MHz.
- 3 When you finish speaking, release the **[PTT]** switch.

Note: When the transceiver overheats because of ambient high temperature or continuous transmission, the protective circuit may function to lower the transmit output power.

Selecting an Output Power

Selecting a low transmit power is a wise method to reduce battery consumption, if communication is still reliable. You can program separate transmit power settings for band A and B.

Press **[F]**, **[MENU]** to select high (default), low, or economic low power (lowest).

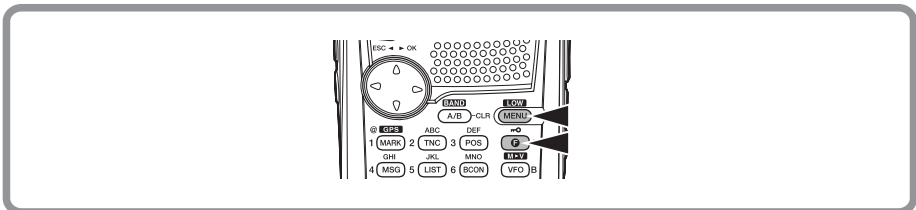

- “H”, “L”, or “EL” appears to show the current selection.

- When the RF power meter is H, all 9 points are displayed. When it is L, 5 points are displayed, and when it is EL, 2 points are displayed.

BACKLIGHT

Press **[LAMP]** to illuminate the display and keys.

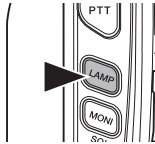

- If no other key is pressed, the light turns OFF approximately 5 seconds after releasing **[LAMP]**.
- Press any key (including **[PTT]**) other than **[LAMP]** while the display and keys are lit to restart the 5-second timer.
- Press **[LAMP]** while the display and keys are lit to immediately turn the light OFF.

Press **[F]**, **[LAMP]** to keep the light ON continuously.

- The light remains ON until you press **[F]**, **[LAMP]** again.

Note:

- ◆ You can set the Display lighting time in Menu No. 101.
 - ◆ Press any key other than **[LAMP]** to change the lighting setting (Menu No. 102).
-

MONITOR

When you are receiving while the squelch function is ON, weak signals may become intermittent.

If the CTCSS or DCS function is ON, you may want to disable the squelch function temporarily to monitor the current channel activities.

- 1 Press and hold **[MONI]**.

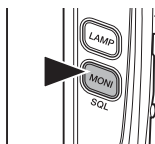

- The speaker is unmuted and you can monitor the signals.

- 2 Release **[MONI]** to return to normal operation.

SETUP OPERATION

Function Select Mode

Press **[F]** to enter Function Select mode. In this mode you can scroll F-0 through F-# by pressing **[▲]/[▼]** or rotate the **Tuning** control. After accessing the desired function, press **[▶OK]**, then press **[▲]/[▼]** or rotate the **Tuning** control to select the desired parameter.

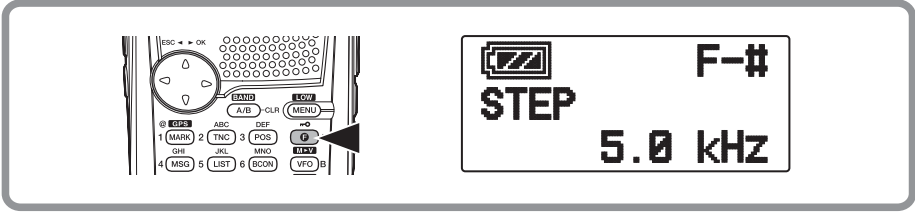

Pressing **[F]**, **[0] ~ [9]** or **[*]**, **[#]** is a much simpler method. For example, pressing **[F]**, **[*]** switches the Shift function ON or OFF. (Refer to the keypad explanations on pages 10 ~ 11.)

Note: You can verify the battery capacity while in Function Select mode.



Full



Medium



Low



Very Low (recharge)

Menu Mode

Press **[MENU]** to enter Menu mode. In this mode you can access the desired menu item by pressing **[▲]/[▼]** or rotate the **Tuning** control and **[▶OK]** or entering digits directly from the keypad (0 ~9, A, B, C, D, E (*),and F (#) only). For further information, refer to “MENU MODE” {page 23}.

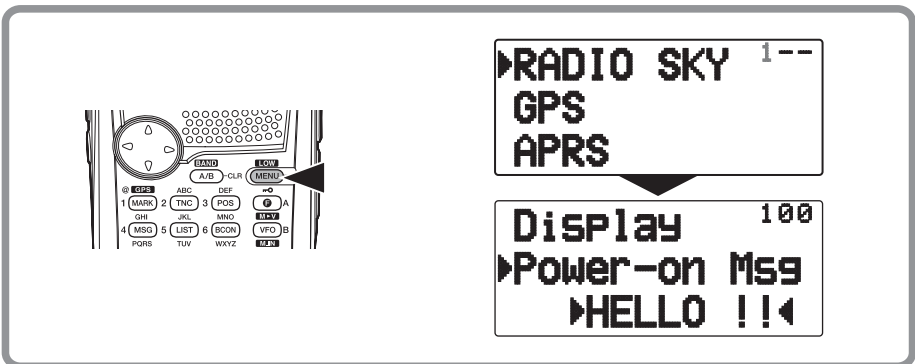

MENU MODE

Many functions on this transceiver are selected or configured through the Menu instead of physical controls. Once you become familiar with the Menu system, you will appreciate the versatility it offers.

MENU ACCESS

- 1 Press **[MENU]** to access the Menu.
 - The setup category name appears on the display.



The LCD display shows the menu category selection screen. The text on the screen is: ▶RADIO SKY 1-- (top line), GPS (second line), and APRS (third line). The number '1--' is in the top right corner.

- 2 Press **[▲]/[▼]** or rotate the **Tuning** control to select your desired category.
- 3 Press **[▶OK]** to set the category.
 - The Menu name and number appear on the display.

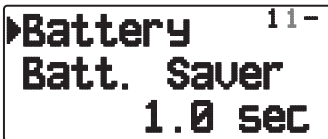

The LCD display shows the menu item selection screen. The text on the screen is: ▶Battery 11- (top line), Batt. Saver (second line), and 1.0 sec (third line). The number '11-' is in the top right corner.

- 4 Press **[▲]/[▼]** or rotate the **Tuning** control to select your desired Menu.
- 5 Press **[▶OK]** to set the Menu.

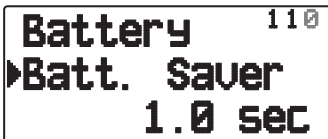

The LCD display shows the menu item selection screen. The text on the screen is: Battery 110 (top line), ▶Batt. Saver (second line), and 1.0 sec (third line). The number '110' is in the top right corner.

- 6 Press **[▲]/[▼]** or rotate the **Tuning** control to select your desired value for the Menu.



The LCD display shows the menu item selection screen. The text on the screen is: Battery 111 (top line), ▶Batt. Saver (second line), and 2.0 sec (third line). The number '111' is in the top right corner.

- 7 Press **[▶OK]** to set the selected value.
- 8 Repeat steps 2 to 7 to set up additional Menus.
- 9 Press **[MENU]** to exit Menu mode.

MENU CONFIGURATION

RADIO - Display			
No.	Display	Description	Setting Values
100	Power-on Msg	Power-on message edit	Up to 8 characters
101	Lamp timer	Display lighting time	2 ~ 5 ~ 10 sec
102	Lamp Control	Display lighting control	Manual/ Auto
103	Contrast	Display contrast	Level 1 ~ 8 ~ 16

RADIO - Battery			
No.	Display	Description	Setting Values
110	Batt. Saver	Battery saver time	Off/ 0.03/ 0.2/ 0.4/ 0.6/ 0.8/ 1.0/ 2.0/ 3.0/ 4.0/ 5.0 sec
111	APO	Auto power off time	Off/ 15/ 30/ 60 min
112	Battery Type	Battery type select	Lithium/ Alkaline

RADIO - Audio			
No.	Display	Description	Setting Values
120	Balance	Band A/B volume balance	5 step
121	Key Beep	Key Beep sound	RADIO & GPS/ RADIO Only/ GPS Only/ Off

RADIO - TX/RX			
No.	Display	Description	Setting Values
130	Prog. VFO	Programmable VFO setup	Varies with the selected frequency band
131	Modulation	Modulation/demodulation mode	AM/ FM/ NFM
132	VHF AIP	VHF band AIP	Off/ On
133	UHF AIP	UHF band AIP	Off/ On
134	VOX	VOX on/off	Off/ On
135	VOX Gain	VOX gain level	Gain 0 ~ 4 ~ 9
136	VOX Delay	VOX delay time	250/ 500/ 750/ 1000/ 1500/ 2000/ 3000 ms
137	VOX on Busy	VOX on busy	Off/ On
138	Beat Shift	Beat shift	Type 1 ~ 8
139	TX Inhibit	TX inhibit	Off/ On
13A ¹	WX Alert	Weather alert	Off/ On
13B ¹	Auto WX Scan	Auto weather channel scan time	Off/ 15/ 30 / 60 min

RADIO - Memory			
No.	Display	Description	Setting Values
140	Name	Memory channel name input	Up to 8 characters
141	Name <> Freq	Name display select	Name/ Freq
142	Lockout	Memory channel lockout	Off/ On
143	Recall Method	Memory channel recall method	All Bands/ Current Band
144	Group Name	Memory group name input	Up to 8 characters
145	Group Link	Memory group link registration	Up to 10 digits (0 ~ 9)
146	EchoLink Mem	EchoLink memory setup	Up to 8 characters for EchoLink memory name Up to 8 digits for DTMF code

RADIO - Scan			
No.	Display	Description	Setting Values
150	Scan Resume	Scan resume method	Time/ Carrier/ Seek
151	Time Restart	Time operate restart time	1 ~ 5 ~ 10 (sec)
152	Car. Restart	Carrier operate restart time	1 ~ 2 ~ 10 (sec)

RADIO - Repeater			
No.	Display	Description	Setting Values
160	Offset Freq	Offset frequency	0.00 ~ 0.60 ~ 29.95 (MHz)
161	Auto Offset	Auto repeater offset	Off/ On
162	CALL Key	CALL key function	Call/ 1750Hz
163	1750Hz Hold	1750Hz Hold	Off/ On

RADIO - DTMF			
No.	Display	Description	Setting Values
170	Memory	DTMF memory	Up to 8 characters for DTMF memory name Up to 16 digits for DTMF code
171	Speed	DTMF memory transmission speed	50/ 100/ 150 ms
172	Pause	DTMF pause code time	100/ 250/ 500/ 750/ 1000/ 1500/ 2000 ms
173	Hold	Hold	Off/ On

RADIO - Lock			
No.	Display	Description	Setting Values
180	Keys & Freq.	Key lock type	Key Lock/ F.Lock/ Key & F.Lock
181	DTMF Keys	DTMF key lock	Off/ On
182	Mic PF Keys	Mic PF key	Off/ On

RADIO - Auxiliary			
No.	Display	Description	Setting Values
190	PF Key	PF key programmable function value	See explanation
191	PF1 (Mic)	Microphone PF1 key programmable function value	
192	PF2 (Mic)	Microphone PF2 key programmable function value	
193	PF3 (Mic)	Microphone PF3 key programmable function value	
194	Date	Date	See explanation
195	Time	Clock time	
196	Time Zone	Time zone	+ 14:00 ~ UTC ~ - 14:00
197	Packet Band	Internal TNC data band type (PACKET)	A-BAND/ B-BAND/ A:TX B:RX/ A:RX B:TX
198	Cursor Shift	Cursor Shift	Off/ 1/ 1.5/ 2 sec
199	Reset	Reset	VFO Reset/ Partial Reset/ Full Reset
19A	Power-on PWD	Power on password	Off/ On

GPS - Int. GPS			
No.	Display	Description	Setting Values
200	Operating Mode	Internal GPS operating mode	Normal/ GPS Only
201	Batt. Saver	Battery saver time	Off/ 1/ 2/ 4/ 8/ Auto
202	PC Output	GPS data output to PC	Off/ On

GPS - Setup			
No.	Display	Description	Setting Values
210	Datum	Datum	WGS-84/ TOKYO
211	Sentence	Sentence	\$GPGGA/ \$GPGLL/ \$GPRMC/ \$GPVTG/ \$GPZDA/ \$GPGSA/ \$GPGSV
212	SBAS	Satellite base augmentation system	Off/ On

GPS - Track Log			
No.	Display	Description	Setting Values
220	Clear All Data	Clear all data	Yes/ No
221	Wrap When Full	Wrap when memory full	Off/ On

GPS - Log Setup			
No.	Display	Description	Setting Values
230	Record Method	Record method	Time/ Distance/ Beacon
231	Interval	Interval time	2 ~ 10 ~ 1800 sec
232	Distance	Distance	0.01 ~ 9.99 (mi/ km/ nm)

GPS - Target Pt.			
No.	Display	Description	Setting Values
240	*1	Number select	1 ~ 5
241	Name	Name entry	Up to 9 characters
242	N (S)	Latitude entry	-
243	E (W)	Longitude entry	-

APRS - Basic Set			
No.	Display	Description	Setting Values
300	My Callsign	Call sign entry	Up to 9 characters
301	Beacon Type	Beacon type	APRS/ NAVITRA
302	APRS Lock	APRS lock	Off/ On/ On & PTT/ On & TNC/ On & PTT & TNC

APRS - Int. TNC			
No.	Display	Description	Setting Values
310	Data Band	Internal data band type	A-Band/ B-Band/ A:TX B:RX/ A:RX B:TX
311	Data Speed	Data communications speed	1200/ 9600 bps

APRS - Int. TNC2			
No.	Display	Description	Setting Values
320	DCD Sense	DCD sense type	D or RxD Band/ Both Bands/ Ignore DCD
321	TX Delay	TX delay time	100/ 150/ 200/ 300/ 400/ 500/ 750/ 1000 ms

APRS - COM Port			
No.	Display	Description	Setting Values
330	Baud Rate	COM port Baud rate speed	2400/ 4800/ 9600 bps
331	Input	COM port input type	Off/ GPS/ Weather (PeetBros) / Weather (Davis)
332	Output	COM port output	Off/ Waypoint

APRS - Waypoint			
No.	Display	Description	Setting Values
340	Format	Way point format	NMEA/ MAGELLAN/ KENWOOD
341	Length	Way point name length	6-Char ~ 9-Char
342	Output	Way point output type	All/ Local/ Filtered

APRS - PC Port			
No.	Display	Description	Setting Values
350	Output	COM port output	Off/ On

APRS - MyPosition			
No.	Display	Description	Setting Values
360	✖1	Number select	1 ~ 5
361	Name	Name entry	Up to 8 characters
362	N (S)	Latitude entry	–
363	E (W)	Longitude entry	–

APRS - BeaconInfo			
No.	Display	Description	Setting Values
370	Speed	Speed information	Off/ On
371	Altitude	Altitude information	Off/ On
372	Pos. Ambiguity	Position ambiguity mode	Off/ 1-Digit ~ 4-Digit

APRS - Comment			
No.	Display	Description	Setting Values
380	Position Comment	Position Comment	Off Duty/ Enroute/ In Service/ Returning/ Committed/ Special/ PRIORITY/ CUSTOM 0 ~ CUSTOM 6/ EMERGENCY!

APRS - StatusText			
No.	Display	Description	Setting Values
390	✖1	Number select	1 ~ 5
	TX Rate	Status text TX rate	Off/ 1/1 ~ 1/8
	Text	Text	Up to 48 characters

APRS - QSY(FREQ)			
No.	Display	Description	Setting Values
3A0	QSY in Status	QSY in Status	Off/ On
3A1	Tone/Narrow	Tone/ Narrow	Off/ On
3A2	Shift/Offset	Shift/ Offset	Off/ On

APRS - Pkt.Filter			
No.	Display	Description	Setting Values
3B0	Position Limit	Position limit	Off/ 10 ~ 2500 (mile/ km)
3B1	Filter Type	Filter Type	See explanation

APRS - Icon			
No.	Display	Description	Setting Values
3C0	KENWOOD	Icon	See explanation
3C1	Symbol	Symbol	
3C2	Table	Table	

APRS - TX Beacon			
No.	Display	Description	Setting Values
3D0	Method	Method	Manual/ PTT/ Auto/ SmartBeaconing
3D1	Initial Interval	Initial interval time	0.2/ 0.5/ 1/ 2/ 3/ 5/ 10/ 20/ 30 min

APRS - Algorithm			
No.	Display	Description	Setting Values
3E0	Decay Algorithm	Decay algorithm	Off/ On
3E1	Prop.Pathing	Proportional pathing	Off/ On

APRS - SmartBcon1			
No.	Display	Description	Setting Values
3F0	Low/High Speed	Low speed/ High speed setting	Low speed: 2 ~ 05 ~ 30 High speed: 2 ~ 70 ~ 90
3F1	Slow Rate	Low speed transmission interval time	1 ~ 30 ~ 100 min
3F2	Fast Rate	High speed transmission interval time	10 ~ 120 ~ 180 sec

APRS - SmartBcon2			
No.	Display	Description	Setting Values
3G0	Turn Angle	Driving direction change, minimum value setting	5 ~ 28 ~ 90 deg
3G1	Turn Slope	Driving direction change, additional value setting	1 ~ 26 ~ 255 (10deg/speed)
3G2	Turn Time	Minimum time delay between each beacon transmission	5 ~ 30 ~ 180 sec

APRS - PacketPath			
No.	Display	Description	Setting Values
3H0	Type	Packet path type	New-N/ Relay/ Region/ Others
3H1	Wide1-1 / Relay / ABBR / Others	Wide1-1 / Relay / ABBR / Others	Off/ On (Wide1-1,Relay) , Up to 5 characters (ABBR), Up to 79 characters (Others)
3H2	Total Hops	Total Hops	0 ~ 2 ~7

APRS - Network			
No.	Display	Description	Setting Values
3I0	APRS [APK003]	APRS (APK003)	check
3I1	Altnet []	Altnet	Up to 6 characters

APRS - WX Station			
No.	Display	Description	Setting Values
3J0	TX	Weather TX	Off/ On
3J1	TX Interval	Weather TX interval time	5/ 10/ 30 / 60 min

APRS - Digipeat			
No.	Display	Description	Setting Values
3K0	Digipeat(MyCall)	Digipeat function	Off/ On

APRS - UIcheck			
No.	Display	Description	Setting Values
3L0	Time	UI check time	0 ~ 28 ~ 250 sec

APRS - Uldigipeat			
No.	Display	Description	Setting Values
3M0	Uldigi	Uldigi	Off/ On
3M1	Aliases	Aliases	Up to 9 characters x 4

APRS - Uiflood			
No.	Display	Description	Setting Values
3N0	Uiflood	Uiflood	Off/ On
3N1	Alias	Alias	Up to 5 characters
3N2	Substitution	Substitution	ID/ NOID/ FIRST

APRS - Ultrace			
No.	Display	Description	Setting Values
3O0	Ultrace	Ultrace	Off/ On
3O1	Alias	Alias	TEMP/ Up to 5 characters

APRS - Phrases			
No.	Display	Description	Setting Values
3P0	User Phrase	User phrases	Up to 32 characters x 8 phrases

APRS - Auto-Reply			
No.	Display	Description	Setting Values
3Q0	Reply	Auto message reply	Off/ On
3Q1	Reply To	Reply to	* / Up to 9 characters

APRS - Reply MSG			
No.	Display	Description	Setting Values
3R0	Text	Auto message reply text	Up to 50 characters

APRS - Group Fitr			
No.	Display	Description	Setting Values
3S0	Message	Message group	ALL, QST, CQ, KWD/ Up to 9 characters x 6 codes
3S1	Bulletin (BLN)	Bulletin (BLN) group	Up to 4 characters x 6 groups

APRS - Sound			
No.	Display	Description	Setting Values
3T0	RX Beep	RX Beep	All/ All New/ Mine/ Message Only/ Off
3T1	TX Beep (Beacon)	TX Beep (Beacon)	Off/ On
3T2	Special Call	Special call	Up to 9 characters

APRS - Display			
No.	Display	Description	Setting Values
3U0	Display Area	Display Area	Entire Disp/ Entire Always/ One Line
3U1	Interrupt Time	Interrupt Time	3/ 5/ 10 sec/ Infinite
3U2	Cursor Control	Cursor Control	Followed/ Fixed

APRS - Units 1			
No.	Display	Description	Setting Values
3V0	Speed, Distance	Speed/ Distance	mi/h, mile/ km/h, km/ knots, nm
3V1	Altitude, Rain	Altitude/ Rain	feet, inch/ m, mm
3V2	Temperature	Temperature	°F/ °C

APRS - Units 2			
No.	Display	Description	Setting Values
3W0	Position	Position format	dd° mm. mm' / dd° mm' ss. s"
3W1	Grid format	Grid format	Maidenhead Grid/ SAR Grid (CONV)/ SAR Grid (CELL)

APRS - NAVITRA GP			
No.	Display	Description	Setting Values
3X0	Group Mode	Group mode	Off/ On
3X1	Group Code	Group code	000/ 3 characters

APRS - NAVITRA MS			
No.	Display	Description	Setting Values
3Y0	Message	Message text	Up to 20 characters x 5 messages

SKY - SkyCommand			
No.	Display	Description	Setting Values
500	CMD Callsign	Commander call sign	Up to 9 characters
501	TRP Callsign	Transporter call sign	Up to 9 characters
502	Tone Freq.	Tone frequency	Frequency
503	Sky Command	SKY command	Off/ Commander/ Transporter

¹ Available only for the TH-D72A.

Note: Default settings are subject to change.

CHARACTER ENTRY

Certain menus require you to enter characters, such as the power on message and memory names. When character entry is required, a cursor will appear on the display.

1 Press **[▶OK]**.

- The cursor will blink.



2 Press **[▲]/[▼]** or rotate the **Tuning** control to select your desired character.

3 Press **[▶OK]** to set the selected character.

- The cursor will move to the next digit.



- You can move the cursor to the left or right by pressing **[ESC ◀]** or **[▶OK]**.
- You can delete the selected character by pressing **[A/B (CLR)]**.
- Press and hold **[LAMP]** and then press **[▲]/[▼]** or rotate the **Tuning** control to select your desired letter type.

4 Repeat steps 2 and 3 to enter the remaining characters.

- Press **[MENU]** to register the entered characters.

Auto Cursor Shift

Auto Cursor Shift will automatically shift the cursor to the next character after a character has been entered. This function lets you set up the time delay after character entry for the automatic cursor shift. If this function is set to OFF, you must manually shift the cursor by pressing **[▶OK]**.

1 Enter Menu mode and access Menu 198.

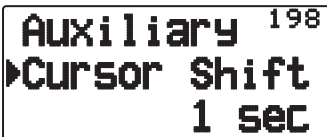

2 Set the desired shift time to Off (manual shift), 1, 1.5, or 2 sec.

Keypad Character Entry

The keypad can also be used to enter characters. Refer to the table below for characters corresponding to keypad.

- When using a character selection method (such as with the keypad or encoder), the characters will differ depending on the character entry type (for example, call sign entry and memory name entry, etc).

Key	Character Display (with each press of the key)								
1	@	/	.	-	_	:	1	,	+
2	a	b	c	2	A	B	C		
3	d	e	f	3	D	E	F		
4	g	h	i	4	G	H	I		
5	j	k	l	5	J	K	L		
6	m	n	o	6	M	N	O		
7	p	q	r	s	7	P	Q	R	S
8	t	u	v	8	T	U	V		
9	w	y	z	z	9	W	X	Y	Z
0	Space	0							
*	Not used								
#	?	!	'	.	,	-	/	&	#
	%	()	<	>	;	:	"	@

OPTIONS

The following options are available for use with this transceiver:

- | | | | |
|----------|-------------------------------|------------|------------------------|
| • PB-45L | Li-ion battery pack | • HMC-3(G) | Headset |
| • BT-15 | Battery case | • KHS-21 | Headset |
| • KSC-32 | Rapid charger | • KHS-29F | Headset |
| • SMC-32 | Speaker microphone | • EMC-7 | Clip microphone |
| • SMC-33 | Speaker microphone | • PG-3J | Cigarette lighter cord |
| • EMC-3 | Clip microphone with earphone | • PG-2W | DC cable |
| | | • PS-60 | DC Power Supply |

Note: Optional accessories for use with this transceiver may change, post-production. (New options may become available and/or current options may be discontinued.) Please refer to the options catalog(s) for applicable transceivers.

MEMORY CONTROL PROGRAM MCP-4A

The following functions can be set only by using the MCP-4A software:

- Power on password value
- Bitmap setting of the Power ON graphic

Using the MCP-4A software, you can:

- View memory channel groups
- Save/load settings
- Read exported TravelPlus for Repeaters™ files issued from the ARRL™
(There are some version restrictions; refer to the help text of the MCP-4A.)
- Export memory and various settings in html

(TravelPlus for Repeaters is a trademark of ARRL.)

To download the MCP-4A software, go to:

http://www.kenwood.com/i/products/info/amateur/software_download.html

Note: This URL may change without notice.

Using the MCP-4A Software

- 1 Follow the directions of the installer to install the software.
- 2 Set up the PC COM port.
- 3 The transceiver data is read from the MCP-4A software.
- 4 Select your desired settings, then write the data to the transceiver.

MAINTENANCE

GENERAL INFORMATION

This product has been factory aligned and tested to specification before shipment. Attempting service or alignment without factory authorization can void the product warranty.

SERVICE

When returning this product to your dealer or service center for repair, pack it in its original box and packing material. Include a full description of the problem(s) experienced. Include your telephone number along with your name and address in case the service technician needs to contact you; if available, also include your fax number and e-mail address. Don't return accessory items unless you feel they are directly related to the service problem.

You may return this product for service to the authorized **Kenwood** dealer from whom you purchased it, or any authorized **Kenwood** service center. Please do not send subassemblies or printed circuit boards; send the complete product. A copy of the service report will be returned with the product.

SERVICE NOTE

If you desire to correspond on a technical or operational problem, please make your note legible, short, complete, and to the point. Help us help you by providing the following:

- Model and serial number of equipment
- Question or problem you are having
- Other equipment in your station pertaining to the problem



CAUTION

Do not pack the equipment in crushed newspapers for shipment! Extensive damage may result during rough handling or shipping.

Note:

- ◆ Record the date of purchase, serial number and dealer from whom this product was purchased.
- ◆ For your own information, retain a written record of any maintenance performed on this product.
- ◆ When claiming warranty service, please include a photocopy of the bill of sale or other proof-of-purchase showing the date of sale.

CLEANING

To clean the case of this product, use a neutral detergent (no strong chemicals) and a damp cloth.

TROUBLESHOOTING

The problems described in this table are commonly encountered operational malfunctions and are usually not caused by circuit failure.

Problem	Probable Cause	Corrective Action
Nothing appears on the display when the transceiver is switched ON, or the display is blinking ON and OFF.	<ol style="list-style-type: none"> 1 The battery pack is discharged. 2 The DC cable or connection is bad. 3 The power supply fuse is open (blown). 	<ol style="list-style-type: none"> 1 Recharge the battery pack or replace the battery. 2 Replace the cable. 3 Investigate the cause for the open fuse and replace the fuse.
Most keys and the Tuning control do not function.	<ol style="list-style-type: none"> 1 One of the Lock functions is ON. 2 The transceiver is in Channel Display mode. 	<ol style="list-style-type: none"> 1 Unlock all of the Lock functions. 2 With the transceiver power OFF, press [PTT] + [A/B] + Power ON to exit Channel Display mode.
You cannot select the exact desired frequency using the Tuning control.	Programmable VFO frequency range is too narrow.	Expand the frequency range in Menu No. 130 (Prog.VFO).
Memory channels cannot be selected by turning the Tuning control or by pressing [▲]/[▼] .	No data has been stored in any Memory channel.	Store data in some Memory channels.
The receiving sound volume is weak even if the signal is strong.	The receiving station may be operating in narrow band FM bandwidth.	Access Menu No. 131 (Modulation) to select "NFM".
Turning the VOL control does not allow you to hear audio.	The selective call function (CTCSS or DCS) is ON.	Turn OFF the selective call function.

Problem	Probable Cause	Corrective Action
You cannot transmit by pressing the PTT switch.	<ol style="list-style-type: none"> 1 You selected a frequency outside the allowable range. 2 You selected a transmit offset that places the transmit frequency outside the limit. 3 TX inhibit is ON. 4 The battery pack voltage is too low to transmit. 	<ol style="list-style-type: none"> 1 Select a frequency within the allowable transmit frequency range. 2 Select a proper offset direction or offset frequency. 3 Access Menu No. 139 (TX inhibit) and select "Off". 4 Charge or replace the battery pack.
Repeater cannot be accessed.	<ol style="list-style-type: none"> 1 Wrong tone frequency is selected. 2 Wrong offset frequency is selected. 3 Wrong shift direction is selected. 	<ol style="list-style-type: none"> 1 Select a proper repeater access tone. 2 Access Menu No. 160 (Offset Freq) and select an appropriate offset frequency. 3 Try other shift directions.
DTMF tone cannot be transmitted.	DTMF Lock is ON.	Access Menu No. 181 (DTMF Keys) and select "Off".
Repeater does not accept your DTMF tones.	DTMF tone transmission duration is too short.	Access Menu No. 171 (Speed) and select "150 ms".
You cannot transmit by pressing [PTT] .	<ol style="list-style-type: none"> 1 You selected a frequency outside the allowable range. 2 You selected a transmit offset that places the transmit frequency outside the limit. 3 TX inhibit is ON. 4 The battery pack voltage is too low to transmit. 	<ol style="list-style-type: none"> 1 Select a frequency within the allowable transmit frequency range. 2 Select a proper offset direction or offset frequency. 3 Access Menu No. 139 (TX inhibit) and select "Off". 4 Change or replace the battery pack.

Problem	Probable Cause	Corrective Action
Transceiver transmits without pressing [PTT] .	VOX function is ON.	Access Menu No. 134 (VOX) and select "Off".
The transceiver switches OFF for no apparent reason.	The Automatic Power OFF (APO) function is ON.	Access Menu No. 111 (APO) and select your desired time length or "Off".
The Scan function does not resume scanning after the transceiver detects a signal.	You have selected "Seek" for Menu No. 150 (Scan Resume).	Select either "Time" (Time-Operated) or "Carrier" (Carrier-Operated) for Menu No. 150 (Scan Resume).
Packet operation results in no connects with other stations.	<ol style="list-style-type: none"> 1 The squelch is open. 2 You did not select the same transfer rate as the target station. 	<ol style="list-style-type: none"> 1 Select the correct squelch level so that the squelch is opened only when signals are present. 2 Use HBAUD command to select the appropriate transfer rate.
When transmitting in full duplex mode, another signal is being received at the same time.	You are receiving the transmitted signal of your station.	<p>Change your settings to a transmit frequency that does not receive the signal, or change the receive frequency.</p> <p>Example frequency setting :</p> <p>Transmit frequency of 146.000 MHz and receive frequency of 439.600 MHz</p>
You cannot transmit any APRS data.	<ol style="list-style-type: none"> 1 Beacon is OFF. 2 The squelch is open. 3 The data band is inactive. 4 The built-in TNC is OFF. 5 You selected Packet mode. 	<ol style="list-style-type: none"> 1 Press [BCON] to switch Beacon ON. 2 Select the correct squelch level so that the squelch is opened only when signals are present. 3 If you have blanked the data band, press [A/B] or [DUAL] to active it. 4 Press [TNC] to switch ON the TNC. 5 Press [TNC] twice so that only "APRS" appears.

Problem	Probable Cause	Corrective Action
When using a GPS receiver, you cannot correctly transmit position data.	The GPS receiver did not yet start correct measurement.	Before starting correct measurement, the GPS receiver generates a low-pitch tone every 10 seconds. When starting correct measurement, it generates a high-pitch tone. (If not using the internal GPS receiver, press [F] , [MARK] and select "OFF").
You cannot receive any APRS data.	You did not correctly program a group code.	Access Menu 3S0 and program "APK003".
"MCP ERR" appears on the display. (MCP-4A communications error)	<ol style="list-style-type: none"> 1 Loose cable connection. 2 Your PC may be trying to process too much at once. 3 There are other reasons as to why communications was not possible. 	<ol style="list-style-type: none"> 1 Ensure that the connection between the TH-D72 and the PC is correct. 2 Shut down other software that you may be running. 3 Turn the TH-D72 power source OFF and ON, one time.

Concerning the received frequency display, an unmodulated signal may be received. This is according to the set intrinsic frequency form.

	<A band>	<B band>	
VxU reception	(144 MHz + 49.95 MHz) x 2	– (430 MHz - 45.05 MHz)	= 45.05 MHz, 49.95 MHz
	(144 MHz + 49.95 MHz) x 4	– (430 MHz - 45.05 MHz) x 2	= 45.05 MHz, 49.95 MHz
UxV reception	(430 MHz - 49.95 MHz)	– (144 MHz + 45.05 MHz) x 2	= 45.05 MHz, 49.95 MHz
	(430 MHz - 49.95 MHz) x 2	– (144 MHz + 45.05 MHz) x 4	= 45.05 MHz, 49.95 MHz

GPS setting: 16.369 MHz x n (n = multiple)

SPECIFICATIONS

General					
Frequency range	Band A & B	TH-D72A	TX <VHF>	144 ~ 148 MHz	
			TX <UHF>	430 ~ 450 MHz	
		TH-D72E	TX <VHF>	144 ~ 146 MHz	
			TX <UHF>	430 ~ 440 MHz	
	Band A			RX <VHF>	136 ~ 174 MHz
				RX <UHF>	410 ~ 470 MHz
	Band B			RX <VHF>	118 ~ 174 MHz
				RX <UHF>	320 ~ 524 MHz
Mode			F1D/ F2D/ F3E		
Antenna impedance			50 Ω		
Operating temperature range			-20°C ~ +60°C (-4°F ~ +140°F)		
			with PB-45L	-10°C ~ +50°C (+14°F ~ +122°F)	
Rated voltage	External power supply (DC IN)		DC 12.0 ~ 16.0 V (13.8 V nominal)		
	Battery terminals		DC 5.5 ~ 9.0 V (7.4 V nominal)		
Ground method			Negative		
Frequency stability			Within ±5 ppm (-10°C ~ +50°C)		
Current	Receive with no signals	Single band		Approx. 100 mA	
		Dual band		Approx. 150 mA	
	Battery Saver ON (Single band)			Approx. 30 mA	
	TNC ON with no signals (Single band)			Approx. 135 mA	
	Transmit with H, 13.8 V (DC IN)			Approx. 1.6 A	
	Transmit with H, 7.4 V (PB-45L)			Approx. 2.0 A	
	Transmit with L, 7.4 V (PB-45L)			Approx. 800 mA	
	Transmit with EL, 7.4 V (PB-45L)			Approx. 500 mA	
	GPS only mode			Approx. 60 mA	
Dimensions (W x H x D) ¹		Projections not included	58 x 121.3 x 33.2 mm (2.28 x 4.78 x 1.31 in)		
		Projections included.	58 x 140 x 39.8 mm (2.28 x 5.51 x 1.57 in)		
Weight ²			Approx. 370 g (13.1 oz)		

¹ With Battery pack (PB-45L)

² Antenna, Battery pack (PB-45L) and Belt hook included.

Note:

- ◆ All specifications (General, Transmitter and Receiver) are guaranteed within the amateur radio band.
- ◆ Specifications are subject to change without notice, due to advancements in technology.

Transmitter		
RF power output	H	5 W/ Approx. 2 W (with BT-15)
	L	Approx. 0.5 W
	EL	Approx. 0.05 W
Modulation		Reactance
Maximum frequency deviation		FM: ± 5 kHz, N-FM: ± 2.5 kHz
Spurious radiation (at high transmit power)		Less than -60 dB
Modulation distortion (300 Hz ~ 3 kHz)		Less than 3 %
Microphone impedance		2 k Ω

Receiver		
Circuitry		Double super heterodyne
Intermediate Frequency (IF)	1st IF (Band A/ Band B)	49.95 MHz/ 45.05 MHz
	2nd IF (Band A/ Band B)	450 kHz/ 455 kHz
Sensitivity (12 dB SINAD)	Band A/ Band B	Less than 0.18 μ V/ 0.22 μ V
Squelch sensitivity		Less than 0.13 μ V
Selectivity	-6 dB	More than 11 kHz
	-50 dB	Less than 30 kHz
Audio output (at 8 Ω / 10% distortion)		More than 300 mW (at 7.4 V)

Sensitivity (approx.) <excluding 144, 430/440 MHz band>

Frequency range	Band A	Band B	
	FM: 12 dB SINAD	FM: 12 dB SINAD	AM: 10 dB S/N
118 ~ 135.995 MHz	—	0.28 μ V	0.4 μ V
136 ~ 143.995 MHz	0.28 μ V	0.28 μ V	—
TH-D72A: 148 ~ 173.995 MHz TH-D72E: 146 ~ 173.995 MHz	0.22 μ V	0.22 μ V	—
320 ~ 339.995 MHz	—	1.26 μ V	2.24 μ V
340 ~ 379.995 MHz	—	0.56 μ V	1.0 μ V
380 ~ 399.995 MHz	—	0.4 μ V	0.4 μ V
400 ~ 409.995 MHz	—	0.22 μ V	—
410 ~ 429.995 MHz	0.22 μ V	0.22 μ V	—
TH-D72A: 450 ~ 469.995 MHz TH-D72E: 440 ~ 469.995 MHz	0.22 μ V	0.22 μ V	—
470 ~ 499.995 MHz	—	0.4 μ V	—
500 ~ 523.995 MHz	—	1.0 μ V	—