



ELECRAFT® K3S

HIGH-PERFORMANCE

160 – 6 METER TRANSCEIVER

KIT ASSEMBLY MANUAL

Revision B3, June 23, 2017

Copyright © 2017, Elecraft, Inc.

All Rights Reserved

E740259

Contents

Key to Symbols and Text Styles.....	4	Initial Power On Check	54
Introduction.....	5	KREF3 Reference Oscillator	54
Customer Service and Support.....	5	Installing the KSYN3A Synthesizer.....	57
Technical Assistance	5	Loudspeaker, Top Cover and KPA3A Shield.....	60
Preventing Electrostatic Discharge Damage	7	KPA3A Shield	62
How ESD Damage Occurs	7	Installing the KNB3 Noise Blanker	63
Preventing ESD Damage.....	7	Installing the Chassis Stiffener	64
Preparing for Assembly	8	Bottom Cover	64
Overview of the Kit.....	8	Bottom Cover Description	64
Tools and Test Equipment Required.....	10	Bottom Cover Hardware Installation Procedure..	64
Unpacking and Inventory	11	KBPF3A General Coverage Receive Option.....	67
Standoffs	11	KBPF3A Description.....	67
Lock Washers.....	11	KBPF3A Installation Procedure	67
Screws	12	Power Amplifier Jumper Block	67
Assembly	13	Battery BT1	68
Front Panel and DSP	14	Battery BT1 Installation Procedure	68
Front Panel and DSP Description.....	14	Finishing the Enclosure	68
Front Panel Assembly Procedure	14	Fan Opening Cover.....	68
Mounting the Sub Receiver Auxiliary DSP		AUX RF Cable	69
Board.....	23	Bottom Covers.....	69
Installing the KDVR3 Digital Voice Recorder		Top Cover	72
Option.....	25	Test and Calibration.....	74
Mounting the DSP Board Assembly on the		Initial Power Checks.....	74
Front Panel	26	Synthesizer Check	74
RF Board and Chassis	28	Filter Setup	75
RF Board Description	28	Reference Oscillator Calibration	75
RF Board and Chassis Assembly	30	TX Gain Calibration	75
Installing Antenna Connectors on the Rear		Option Modules	76
Panel.....	36	Enable Modules	76
Mount Front Panel Assembly on the Chassis.....	40	KPA3A 100-Watt Amplifier Installation.....	76
Installing the KIO3B Interface.....	42	KRX3A Sub Receiver Installation.....	76
Installing Battery BT1	45	Other Calibration Procedures	76
Installing the KANT3 input module or KAT3A		Wattmeter Calibration (Optional).....	76
antenna tuner	49	S-Meter Calibration (Optional).....	76
Installing the Right Side Panel	50	Appendix A, Illustrated Parts List.....	A1
Resistance Checks	53		

 Elecraft manuals with color images may be downloaded from www.elecraft.com.

Key to Symbols and Text Styles

 Identifies important information.

-100 Characters displayed on the LCD screen

DISP *Tap* switch function (labeled *above* a switch)

AVERAGE *Hold* switch function (labeled *below* a switch; hold for 1/2 sec. to activate)

MENU:Font Typical menu entry

Introduction

This manual will guide you through assembly of your Elecraft K3S transceiver. We're confident that you'll find the K3S easy to build, even if you've had no prior kit-building experience.

Every modern transceiver is complex, and the K3S is no exception. The kit includes nearly 300 individual components, including over a dozen PC boards and a multi-element modular chassis. But the unique design of the K3S eliminates some of the tedious aspects of construction, enabling you to complete assembly in far less time than previous high-performance transceiver kits. Also, virtually all of the alignment is handled in firmware using test capabilities built into the K3S.

If you should have difficulty, you'll have our full support via phone and e-mail. In addition, we hope you'll join our growing and enthusiastic community of owner/builders via the Elecraft reflector.

Further information about the Elecraft K3S, including specifications, installation, and operation instructions, can be found in the Owner's Manual.

Elecraft manuals with color images may be downloaded from www.elecraft.com.

Customer Service and Support

Technical Assistance

You can send e-mail to K3support@elecraft.com and we will respond quickly - typically the same day Monday through Friday. Telephone assistance is available from 9 A.M. to 5 P.M. Pacific time (weekdays only) at 831-763-4211. Please use e-mail rather than calling when possible since this gives us a written record of the details of your problem and allows us to handle a larger number of requests each day.

Repair / Alignment Service (We want to make sure everyone succeeds!)

If necessary, you may return your Elecraft product to us for repair or alignment. (Note: We offer unlimited email and phone support to get your kit running, so please try that route first as we can usually help you find the problem quickly.)

IMPORTANT: You must contact Elecraft before mailing your product to obtain authorization for the return, what address to ship it to and current information on repair fees and turn-around times. (Frequently we can determine the cause of your problem and save you the trouble of shipping it back to us.) Our repair location is different from our factory location. We will give you the address to ship your kit to at the time of repair authorization. *Packages shipped without authorization will incur an additional shipping charge for reshipment to our repair depot.*

Elecraft's 1-Year Limited Warranty

This warranty is effective as of the date of first consumer purchase (or if shipped from factory, date product is shipped to customer). It covers both our kits and fully assembled products. For kits, before requesting warranty service, you should fully complete the assembly, carefully following all instructions in the manual.

Who is covered: This warranty covers the original owner of the Elecraft product as disclosed to Elecraft at the time of order. Elecraft products transferred by the purchaser to a third party, either by sale, gift or other method, who is not disclosed to Elecraft at the time of original order, are not covered by this warranty. If the Elecraft product is being bought indirectly for a third party, the third party's name and address must be provided to Elecraft at time of order to insure warranty coverage.

What is covered: During the first year after date of purchase, Elecraft will replace defective or missing parts free of charge (post-paid). We will also correct any malfunction to kits or assembled units caused by defective parts and materials. Purchaser pays inbound shipping to Elecraft for warranty repair, Elecraft will pay shipping to return the repaired equipment to you by UPS ground service or equivalent to the continental USA and Canada. Alaska, Hawaii and outside U.S. and Canada actual return shipping cost paid by owner.

What is not covered: This warranty does not cover correction of kit assembly errors. It also does not cover misalignment; repair of damage caused by misuse, negligence, or builder modifications; or any performance malfunctions involving non-Elecraft accessory equipment. The use of acid-core solder, water-soluble flux solder, or any corrosive or conductive flux or solvent will void this warranty in its entirety. Also not covered is reimbursement for loss of use, inconvenience, customer assembly or alignment time, or cost of unauthorized service.

Limitation of incidental or consequential damages: This warranty does not extend to non-Elecraft equipment or components used in conjunction with our products. Any such repair or replacement is the responsibility of the customer. Elecraft will not be liable for any special, indirect, incidental or consequential damages, including but not limited to any loss of business or profits.

Preventing Electrostatic Discharge Damage

There is no climate or work location where the components of your K3S are safe from Electrostatic Discharge (ESD) unless you take specific steps to prevent such damage. Many of the components in your K3S can be damaged by static discharges of only a few volts: far too little for you to notice. It is those low-voltage but destructive discharges that easily happen anywhere and under virtually any environmental conditions.

ESD damage may not be apparent at first. The damaged components may not fail completely. Instead, the damage may result in below-normal performance for an extended period of time before you experience a total failure.

How ESD Damage Occurs

Whenever an object containing a static charge touches a circuit in your K3S, current will rush into the circuit until the components reach the same voltage as the source of the static charge. If the voltage or current that passes through a component in your K3S during that brief period exceeds its normal operating specifications, it may be damaged or destroyed.

Preventing ESD Damage

ESD damage cannot occur if there is no voltage difference between the components in your K3S and any object that touches them. That is how anti-static packaging works. Anti-static bags allow the static charge to flow over their surface, so that any part of the bag that touches the components inside are all at the same potential at all times. Anti-static foam keeps the leads of sensitive components at the same potential.

At your work bench, avoiding a dangerous voltage is achieved most easily by tying everything together and connecting them to a common mains safety ground. This includes your K3S, individual boards or other sensitive components as well as everything they may touch at the work table.

Inexpensive static dissipating work mats are readily-available that will steadily and safely drain off any charges built up on parts or circuit boards placed on them. They are supplied with a lead that connects the mat to the common workbench ground. Also, metal cabinets on test equipment used on the bench should be tied together and connected to the common ground.

Most importantly, you must have a way of continuously draining off any static charges that occur on your body. Such charges are easy to create, even while sitting quietly at the work bench. Moving your feet on the floor, shifting position in your chair or even moving your arms so that clothing rubs against itself can all produce destructive static charges. You can discharge yourself by touching an unpainted metal ground, but that will last only until you move in a way that produces a new static charge. The safest technique is to wear a grounded wrist strap with a series 1-megohm resistor that continuously drains off any charges. Such wrist straps are readily-available and inexpensive.

WARNING

DO NOT attach a ground directly to yourself without a current-limiting resistor as this poses a serious shock hazard. A wrist strap must include a 1-megohm resistor to limit the current flow. If you choose to touch an unpainted, metal ground to discharge yourself, do it only when you are not touching any live circuits with your other hand or any part of your body.

We strongly recommend you take the following anti-static precautions (listed in order of importance) to avoid trouble:

- Leave ESD-sensitive parts in their anti-static packaging until you install them. The packaging may be a special plastic bag or the component's leads may be inserted in conductive foam. Parts which are especially ESD-sensitive are identified in the parts list and in the assembly procedures.
- Wear a conductive wrist strap with a series 1-megohm resistor. If you do not have a wrist strap, touch a ground briefly before touching any sensitive parts to discharge your body. Do this frequently while you are working. You can collect a destructive static charge on your body just sitting at the work bench. **DO NOT attach a ground directly to yourself as this poses a serious shock hazard.**
- Use a grounded anti-static mat on your work bench.
- If you choose to use a soldering iron to work on your K3S for any reason, be sure the iron is ESD-safe with a grounded tip tied to the same common ground used by your mat or wrist strap.

Preparing for Assembly

Overview of the Kit

The kit comprises two major assemblies: the main chassis and the front panel. Figure 1 shows an assembled K3S/10 with its top cover removed.

The main chassis is literally built up around the RF circuit board, which fills the entire bottom of the unit of the chassis assembly. Panels are mounted around the RF board using Elecraft's 2D fasteners. These fasteners allow individual removal of any one panel, if needed, to gain access to the inside of the radio for servicing. Very few cables or wires are used in the kit. Most of the other boards and optional accessories plug directly into the RF board or one of the boards mounted on the RF board.

The front panel assembly, including the display and main operator controls, includes the front panel board and the digital signal processing (DSP) board.

There are many options that you can add to the basic K3S/10, such as the 100 watt amplifier module, internal antenna tuner, second receiver, additional crystal I.F. filters, etc. If you purchased these options with your K3S kit, you will find instructions to install them at proper places in the assembly procedure to make getting your complete K3S together and operational in the most efficient manner.

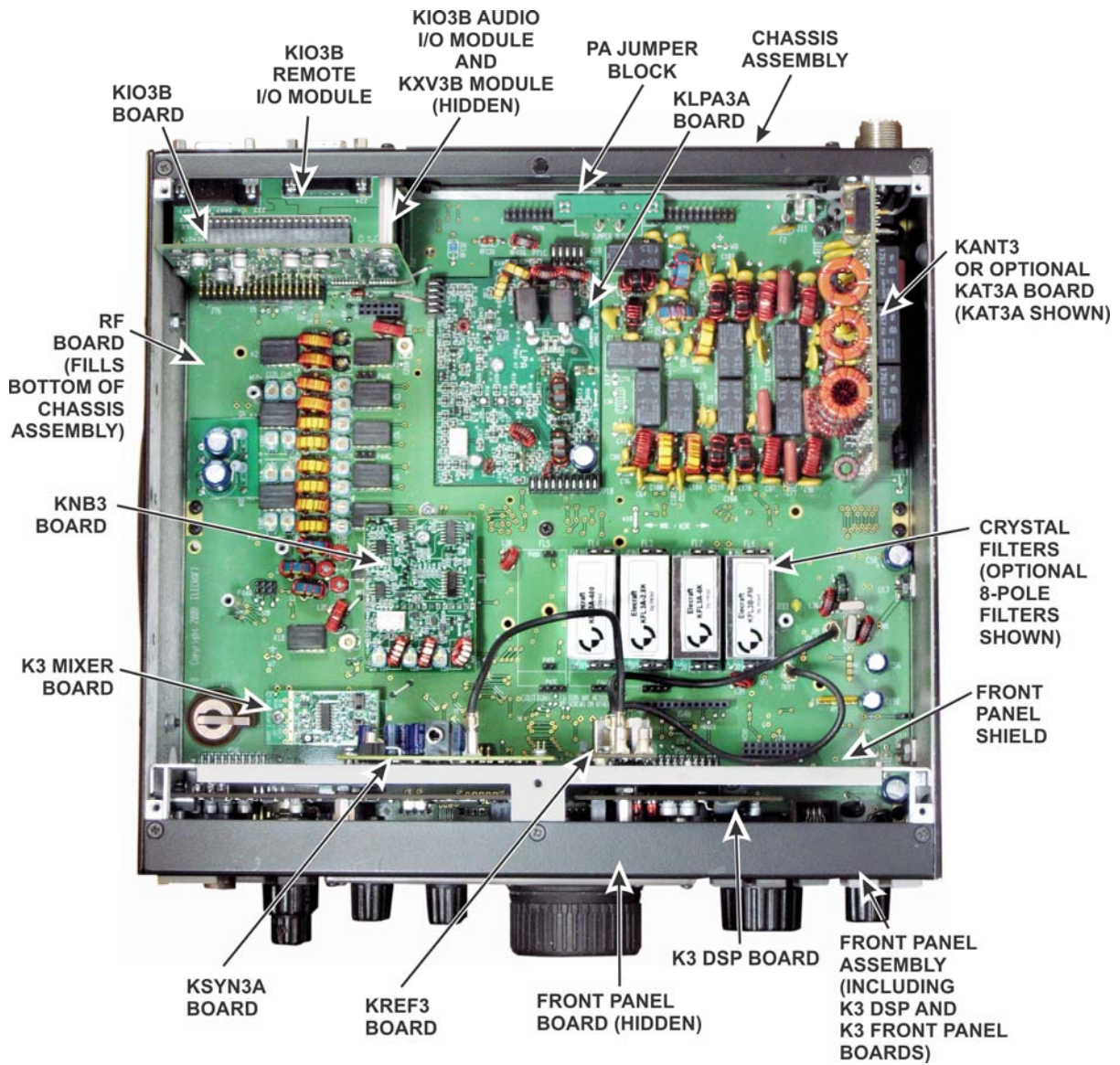

Figure 1. Typical Assembled K3S/10 (Less Top Cover and Chassis Stiffener Bar).

Tools and Test Equipment Required

1. #0 and #1 size Phillips screwdrivers. To avoid damaging screws and nuts, ***do not use a power screwdriver***. Use the screwdriver that best fits the screw in each step.
2. Soft cloth or other surface to lay cabinet panels on to avoid scratching. A clean static-dissipating mat is ideal (see below). ***If using cloth, do not lay circuit boards on it. See Preventing Electrostatic Discharge Damage on page 7.***
3. Pliers or suitable wrenches for tightening 1/4", 3/16" and 1/2" nuts. The 1/2" size is used to tighten nuts on the front panel controls. If available, a deep socket or nut driver is recommended. Pliers or an ordinary wrench can be used, but requires care to avoid damaging the front panel paint.
4. Long nose pliers.
5. Diagonal cutters.
6. Small rule capable of measuring lengths up to 1" (2.5 cm) with an accuracy of at least 1/16" inch (1.6 mm).
7. Digital Multimeter (DMM) for resistance checks.
8. RF 50-ohm, 5 W (minimum) dummy load with low VSWR from 160 meters through 6 meters.
9. Power supply 13.8 VDC nominal (11-15 V) with a cable and Anderson PowerPole® connector. A power cable kit is provided with your K3S if you do not have a suitable cable with the required Anderson PowerPole connector. The power supply must be capable of providing at least 3 Amperes for a K3S/10 and 20 Amperes for a K3S/100. (See *Specifications* in your Owner's manual for more information on power supply recommendations).

The following tools are strongly recommended:

1. ESD wrist strap.
2. Static dissipating work mat.

Optional Equipment:

1. RF Power Meter with accurate readout from 1 mW to 5 watts, minimum.
2. Signal generator with calibrated 50 μ V output at 20 or 40 meters.

In addition, two Allen wrenches, 5/64" (2mm) and .050", are supplied with your kit.

Unpacking and Inventory

CAUTION

Do not handle the circuit boards without anti-static protection! Doing so may damage sensitive components. See *Preventing Electrostatic Discharge Damage* on page 7 for important information before proceeding.

Before starting construction, do a complete inventory, comparing the parts in your kit with the parts list in Appendix A, to familiarize yourself with all of the parts and to ensure the kit is complete. When inventorying, look in the sealed envelopes to identify their contents, but not mix them up. Some screws are very similar in length, but must be used in the correct locations described in the procedure to avoid damaging your K3S. Other screws are stainless steel to be used on the outside of the enclosure. Note that a few extras of some screws, nuts and washers may have been included on purpose.

All dimensions given in the assembly procedure are provided in both US customary (often called English) and metric measurements. The native dimensions of the parts are in US Customary units. Approximate metric equivalents are given to assist those more familiar with that system to identify the correct parts

.Standoffs

A number of threaded standoffs are used. As with the screws and washers, be sure you use the correct size as specified in the text. Standoff lengths are measured from end to end as shown in Figure 2. Standoffs threaded for 2-56 and 4-40 screws are used.

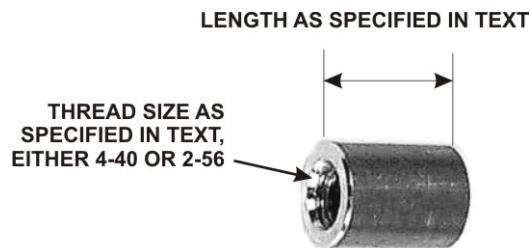

Figure 2. Typical Standoff.

Lock Washers

Two types of lock washers are used in the K3S (see Figure 3). It is important that you use only the type specified and put the washers exactly where indicated. Failing to use the correct type may result in short circuits to nearby circuit traces. Adding washers or placing the washers in the wrong position may cause parts to fail to fit together properly.



Figure 3. Lock Washers.

Screws

A number of different types and sizes of screws and washers are used in the assembly. It is very important that you use the screw specified in each location or your finished K3S may not fit together properly. In some places, using the wrong size screw may damage components. The following various screw types and sizes specified in the text are shown in Figure 5. Images are shown for comparing relative sizes. They are not to scale. The lengths of the screws called for in the text are measured as shown.

⚠ In addition to the screws shown below are two bags of fillister head screws. Do not mix these screws up with other screws or with each other. Keep them in the bags supplied until they are called for in the assembly procedure. Using the wrong length fillister head screw may destroy the K3S display.



Figure 4. Typical Fillister Head Screws.

SCREW AS IDENTIFIED IN TEXT	RELATIVE SIZE (NOT TO SCALE)	MEASURING SCREW LENGTHS
2-56 1/4" (6.4 mm) BLACK PAN HEAD		FROM BOTTOM OF PAN HEAD TO END OF THREADED SHAFT
4-40 3/16" (4.8 mm) BLACK PAN HEAD		
4-40 3/16" (4.8 mm) BLACK FLAT HEAD		
4-40 1/4" (6.4 mm) BLACK PAN HEAD		
4-40 1/2" (12 mm) BLACK FLAT HEAD		
4-40 1/4" (6.4 mm) ZINC PAN HEAD		FROM TOP OF FLAT HEAD TO END OF THREADED SHAFT
4-40 5/16" (7.9 mm) BLACK FLAT HEAD		
4-40 3/8" (9.5 mm) BLACK FLAT HEAD		
4-40 7/16" (11 mm) ZINC PAN HEAD		
4-40 7/16" (11 mm) BLACK PAN HEAD		
4-40 1/2" (13 mm) BLACK FLAT HEAD		
6-32 1/4" (6.4 mm) BLACK FLAT HEAD		
6-32 1/2" (13 mm) BLACK PAN HEAD		

Figure 5. Screw Sizes Used in Assembly.

Assembly

IMPORTANT ASSEMBLY INFORMATION

1. Screws and other Fasteners: A variety of screws and fasteners are used to assemble your K3s:
 - **Stainless Steel Hardware:** Exterior screws are stainless steel to avoid corrosion in harsh environments. Where the stainless steel screws would be impossible to separate from similar screws in a bag of parts, they are supplied in a separate bag marked *E850714 SS Hardware Kit*. The letters (SS) are included in the procedure wherever you should use a stainless steel part from that bag.
 - **Use your rule to check the length of screws and standoffs before installing them.** Some components are only 1/16" different from others but using the wrong size may result in parts not fitting correctly, possibly damage electrical and mechanical components. See *Screws* on page 12 and *Standoffs* on page 11 for more measurement instructions.
 - **Loosen screws as needed for a proper fit.** When mounting parts with multiple screws or adjacent parts that fit together, such as the exterior cabinet panels, loosen adjacent mounting screws as needed to adjust the parts for the best fit. Be certain you re-tighten the screws before proceeding.
 - **Ensure all screws are tight.** A loose screw can cause both mechanical and electrical problems such as intermittent operation, unexpected noise or false signals (birdies) in the receiver.
 - **Threads can be easily stripped** if too much force is applied when tightening screws. Use the correct size hand tool and apply only moderate torque. Do not use a power screwdriver!
2. Connectors: Many of the multi-pin connectors have one pin removed and a plug in the corresponding socket. This is intentional to help you properly align them.

CAUTION – TO AVOID DEGRADING THE PERFORMANCE OF YOUR K3s:

DO NOT DISTURB ANY ADJUSTMENTS ON THE BOARDS!

Each board was tested and aligned for optimum performance at the factory. Any change to these adjustments will degrade the performance of your K3s or prevent its operation altogether. All user calibrations and adjustments are done in firmware using the front panel menus. These are described at the appropriate points in the assembly procedures.

DO NOT ADJUST THE TURNS ON ANY TOROIDS!

The position of the turns on the cores of many toroids has been adjusted at the factory to produce exactly the inductance needed for the circuit to work properly. Any attempt to adjust their position or to make a coil look “nicer” may seriously degrade circuit performance.

Also, do not attempt to fix the turns or coils in place with adhesives or other materials. Those toroids needing support have been fixed at the factory. Adding material to the other toroids will alter their inductance, again degrading circuit performance.

ESD SENSITIVE!

Observe ESD precautions when handling the circuit boards and whenever you are working on your K3s with the covers off. Failure to observe ESD precautions may result in your K3s not operating at all, or operating but not meeting normal factory performance specifications due to damaged components. See page 6 for more information.

Front Panel and DSP

Front Panel and DSP Description

The Front Panel is a large plug-in module that provides the K3S user interface (LCD, switches, shaft encoders, potentiometers, and LEDs) as well as the microcontroller (MCU) and parameter storage (EEPROM and FLASH). It also includes the 32-bit DSP assembly, which processes all AF and IF signals. See *Theory of Operation, Front Panel and DSP*, in the K3S Owner's Manual.

Front Panel Assembly Procedure

CAUTION

Do not use internal tooth lock washers where split lock washers are specified. Internal tooth lock washers are slightly larger and may short nearby circuit pads.

- Mount three standoffs on the back of the front panel board as shown in Figure 6. Place the lock washer between the screw head and the board as shown.

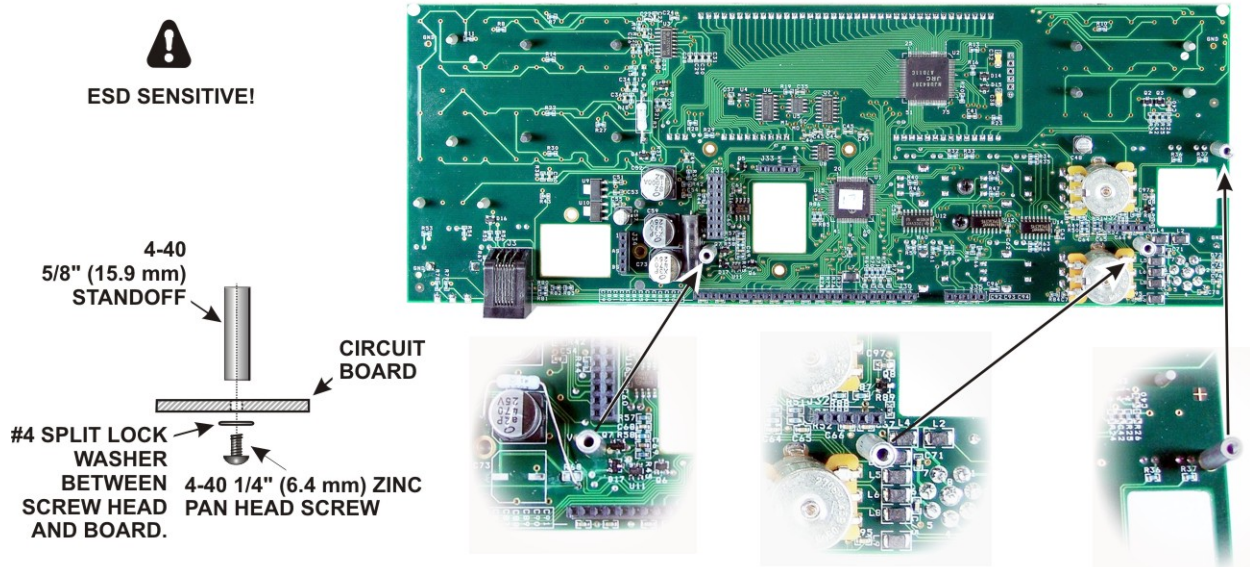

Figure 6. Preparing the Front Panel Board for Mounting, Part 1.

- On the front side of the board, mount four standoffs as shown in Figure 7.

⚠ IMPORTANT!

1. Place the split lock washers between the standoff and board as shown in the figure. This is important to establish the correct spacing between the board and the front panel.
2. Note that the two standoffs near the LCD use smaller #2 hardware.

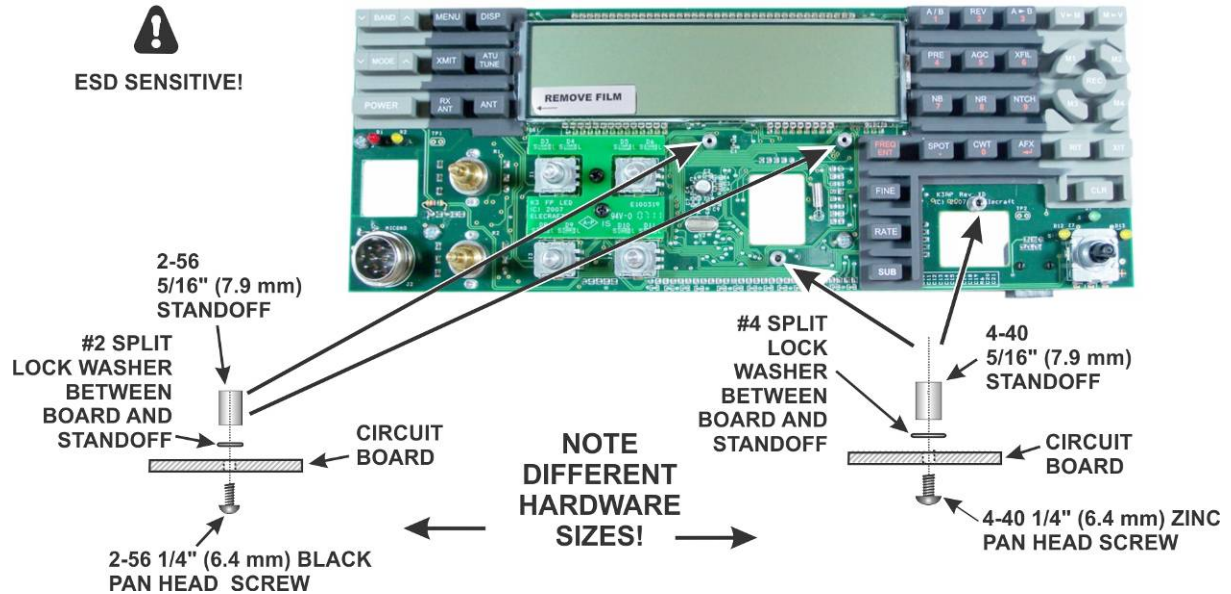

Figure 7. Preparing the Front Panel Board for Mounting, Part 2.

- Inspect the front panel board to verify the following:
 - Three 4-40 5/8" (15.9 mm) standoffs are mounted on the back as shown in Figure 6.
 - Two 4-40 5/16" (7.9 mm) standoffs are mounted on the front as shown in Figure 7.
 - Two 2-56 5/16" (7.9 mm) standoffs are mounted on the front as shown in Figure 7.

If you see a **REMOVE FILM** label on the face of the LCD, there is a thin plastic film covering the LCD front glass(see Figure 8). Pull up on the edge of the paper label marked by an arrow and the label and film will lift off together.

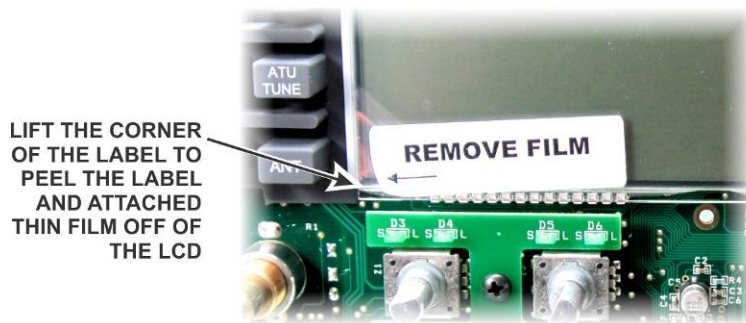

Figure 8. Removing the LCD Protective Film.

Install the two soft foam light blockers at the ends of the LCD display as shown in Figure 9. Remove the paper strip covering the adhesive on each blocker and stick that side against the board (or the lip at the base of the switch buttons) so it stands up between the switches and the LCD. Push them down so the adhesive side is against the board or base of the switches and that they cover ends of the LCD, including the terminals at the right hand end of the LCD as shown.

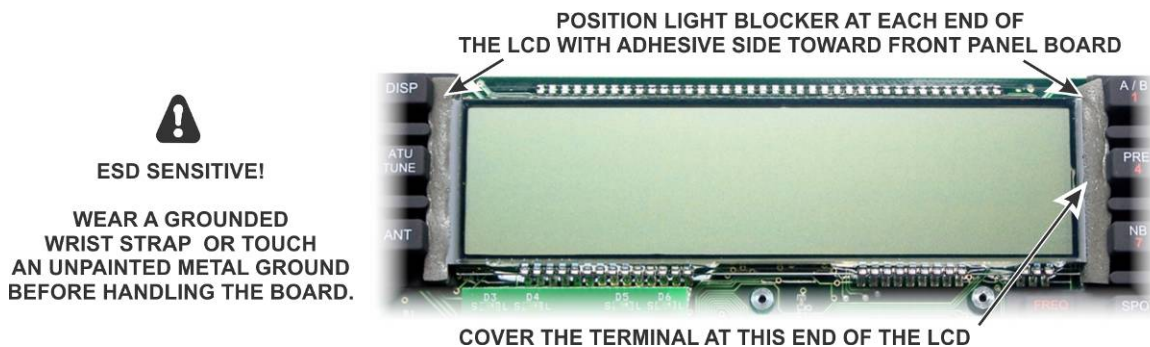

Figure 9. Installing LCD Light Blocker.

Locate the front panel and inspect the inside surface for any masking tape covering the holes left during the painting process. If any is found peel it off. Be sure to check the holes in the top and bottom lips on the front panel for tape, including the center hole in the top lip.

☐ Locate a 2-56 5/32" (4.0 mm) fillister head screw found in the small envelope marked *E850710 Bezel Screws*. Thread the screw through each of the four threaded holes at the corners of the opening in the front panel for the LCD to ensure they are clear of paint (see Figure 10). Lubricate the screw if the fit is tight. A drop of water on the threads will usually work well and it is easier to wipe away excess water than oil. Return the screw to the envelope until it is called for later.



Figure 10. Checking Front Panel 2-56 Threaded Screw Holes.

☐ Place the front panel board face up on your work surface, then set the front panel over it as shown in Figure 11. Check to ensure the LEDs above the four controls under the LCD display, the red and yellow LEDs below the **POWER** button, and the three LEDs above the control in the lower right corner of the panel are positioned in their openings. If necessary, lift the panel off and gently adjust the position of the LEDs.

☐ Ensure the flange on the MIC connector is not caught behind the panel. The flange should be slightly above the panel as shown all the way around its circumference as shown in Figure 11. It may be a snug fit requiring you to press it into place, pushing on the back of the connector. If the connector refuses to fit through the hole in the front panel, use a sharp tool to carefully remove the paint from the inside edge where the connector is binding against the hole. Work from the *inside* of the front panel to avoid damaging the paint on the front edge of the MIC connector hole.

☐ Secure the front panel to the board with a 4-40 3/16" (4.8 mm) black flat head screw (SS) above the control opening near the right end and a 1/2" (13mm) nut and inside tooth lock washer on each concentric pot bushing near the left end as shown. Tighten the screw and nuts only until you feel firm resistance. Be very careful not to scratch the front panel.

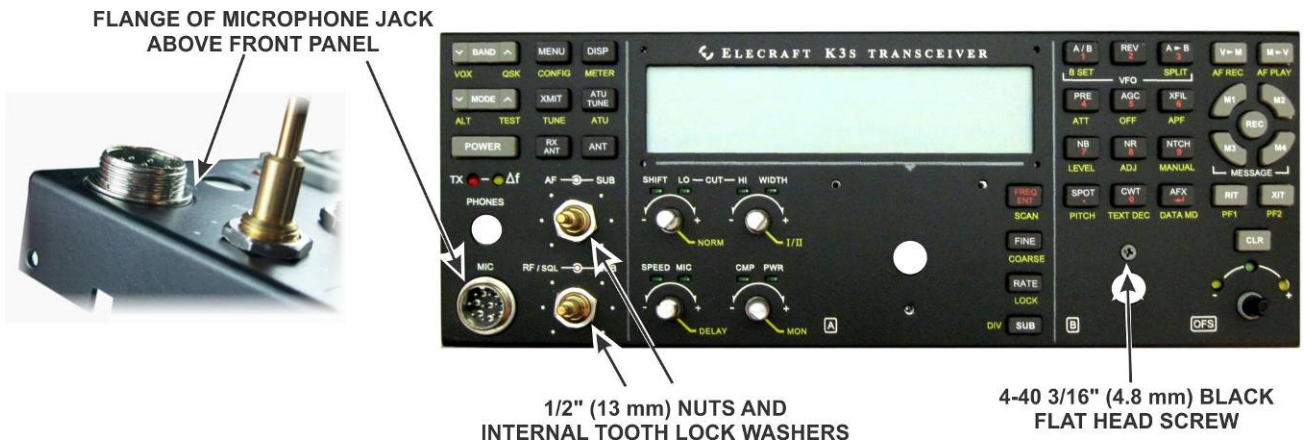

Figure 11. Mounting the Front Panel on the Front Panel Board.

Two identical encoder assemblies are provided for VFO A and VFO B. Select one encoder and place a 1/2" (13mm) inside tooth lock washer over the threaded shaft as shown in Figure 12. This will be the VFO A encoder.



Figure 12. VFO A Encoder Assembly Preparation for Installation.

Place the VFO A encoder in the opening near the center of the front panel board so the shaft protrudes through the opening under the LCD. Be careful to avoid dropping the lock washer into the space between the front panel board and the front panel. Normally, the lock washer hangs on the threads while you put the encoder in place. Optionally, you can hold the encoder with the shaft upright and place the front-panel assembly over it until the shaft is through the hole. Orient the encoder so the pins mate with connector J33 on the front panel board as shown in Figure 13.

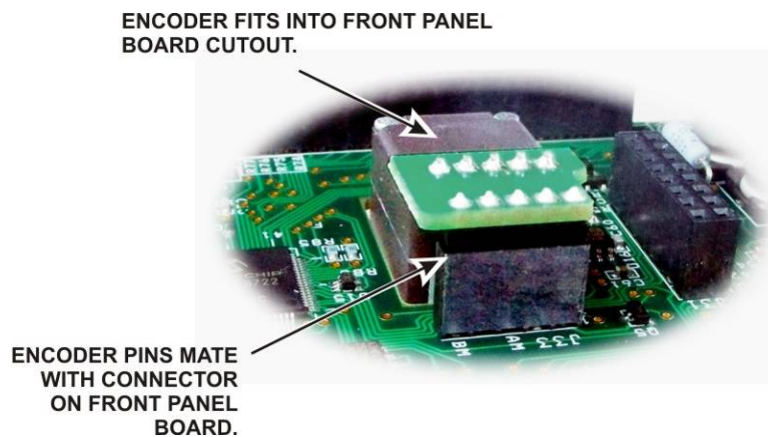

Figure 13. Mounting VFO Encoders.

Place a 1/2" (13mm) inside tooth lock washer and nut on the threaded shaft of the VFO A encoder and tighten them against the front panel.

Prepare the remaining encoder for VFO B as shown in Figure 14. Be sure the nut is tight against the shoulder of the ferrule. Cut only the five pins shown close to the back of the pc board so they do not extend above the solder pads. Cutting them avoids the possibility of a short circuit to an adjacent pc board when the K3S is assembled.

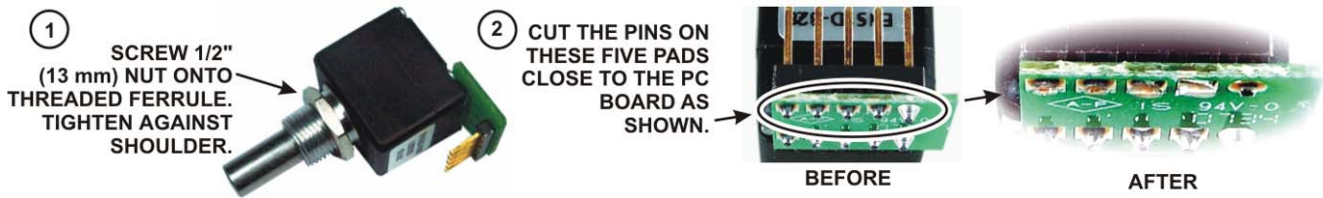

Figure 14. VFO B Encoder Assembly Preparation for Installation.

Place the VFO B encoder in the opening near the end of the front panel board so the nut rests against the inside of the front panel and the encoder pins mate with J34. The connectors may not mate fully, leaving a very small area of the pins showing. That is normal.

Place a 1/2" (13mm) internal tooth lock washer and nut on the threaded shaft of the VFO B encoder and tighten them against the front panel. Take care not to damage the front panel paint with your tools.

Locate the bezel and the bezel lens. Place the bezel face down on your work table. Note that there is a shoulder around the opening for the bezel lens..

Brush or blow any lint or dust from the bezel lens and snap it into the bezel opening as shown in Figure 15.

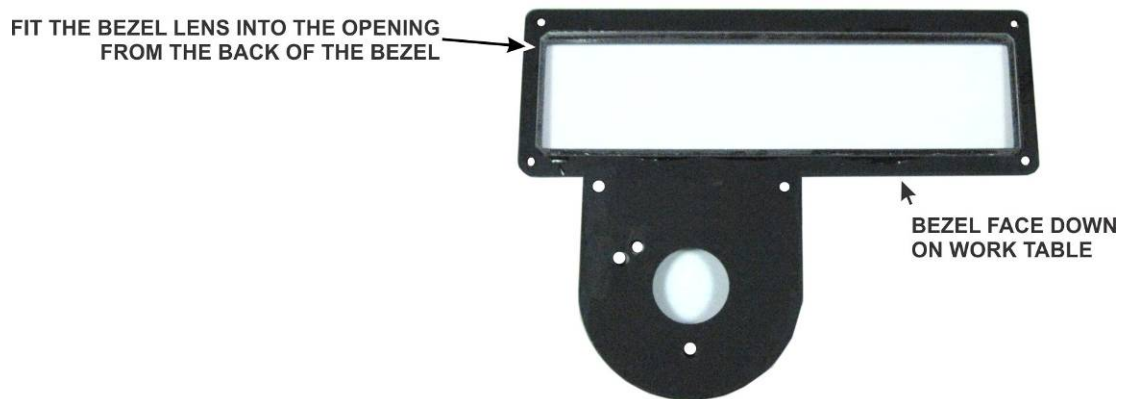

Figure 15. Fitting the Bezel lens in the Bezel.

⚠ CAUTION!

In the next step, use only the screws indicated.

Using the wrong screw may break the LCD cover glass and ruin the display.

☐ Locate the envelope marked *E850710*, *K3s Bezel Screws*. Use only these screws to mount the bezel as shown in Figure 16, with the *shorter* fillister head screws used at the four corners of the display. Take care not to dislodge the lens while mounting the bezel. Once in place the lens is held securely by the bezel and the front panel.

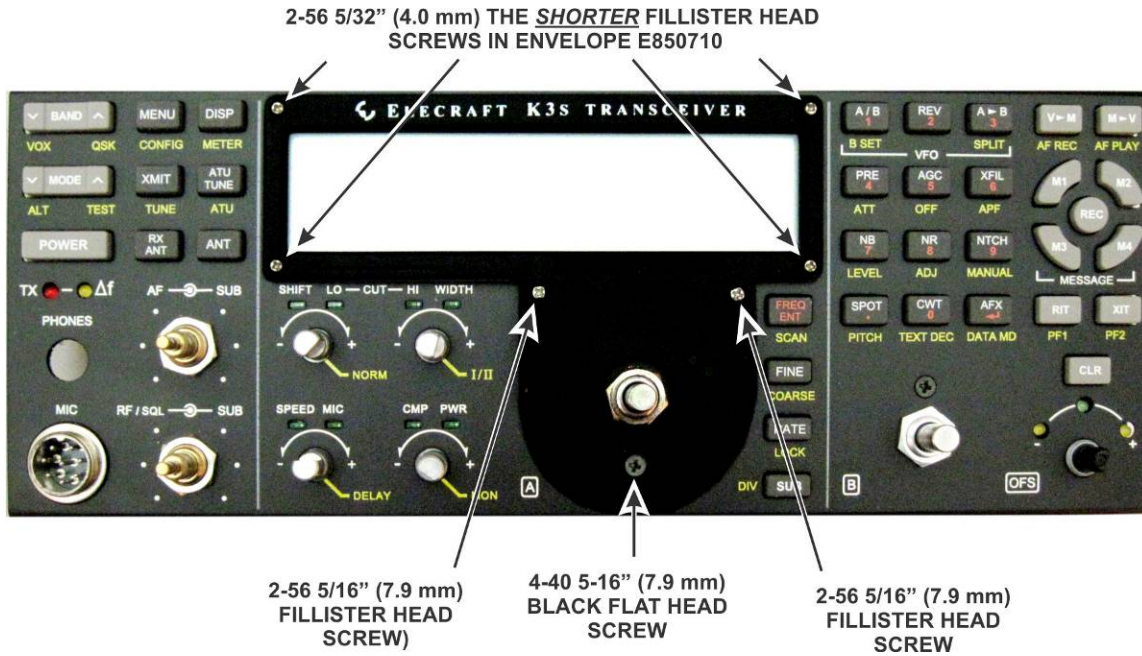

Figure 16. Mounting the Bezel.

☐ Place a second nut on the VFO A threaded ferrule and tighten it against the nut you installed earlier (see Figure 17).

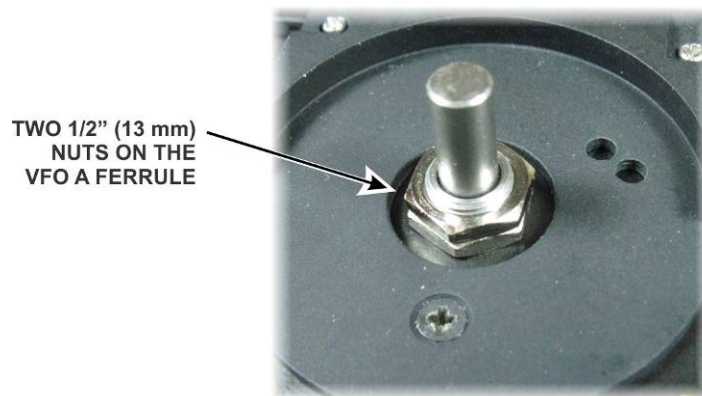

Figure 17. Second Nut on the VFO A Ferrule.

- Place the larger of a pair of concentric knobs over the RF/SQL - SUB control as follows (See Figure 18):

⚠ CAUTION!

Do not over-tighten the set screws in the knobs in the following steps or you may crack the knobs! Use only enough torque to hold the knobs in place.

- Turn both shafts fully clockwise
- Place the larger knob over the shafts. Do not tighten the set screw yet.
- Place the smaller knob over the shaft, align its index line as shown in Figure 18 and tighten one set screw with a 0.050" Allen wrench.
- Rotate the larger knob so its index line is aligned with the index mark in the smaller knob, then lift it gently so it does not bind against the control bushing or the upper knob and tighten one set screw.
- Rotate both knobs about half way counter-clockwise and tighten the second set screw in each knob.
- Rotate the smaller and larger knobs over their entire range to see if moving one knob moves the other at any point in the rotation. If it does, loosen the set screws on the larger knob and move it slightly toward the panel until the knobs operate independently over their entire range of movement.

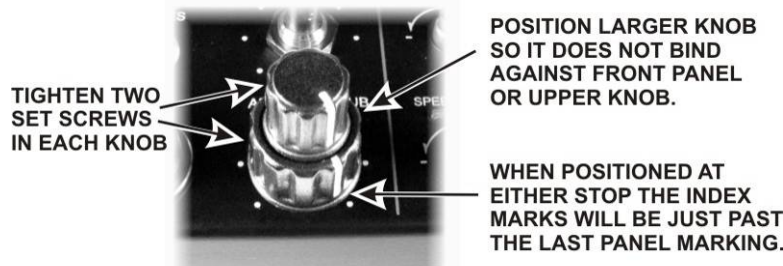

Figure 18. Mounting Concentric Knobs.

- Place a pair of concentric knobs over the AF-SUB controls in the same manner as you installed the RF/SQL-SUB knobs. Don't forget to start by turning both shafts fully clockwise.

⚠ CAUTION!

You may damage the encoders while installing the knobs in the next step unless you align the flats in the knobs with the flats on the shafts as described below.

Press small knobs on the four controls under the left end of the LCD: SHIFT/LOW, HI/WIDTH, SPEED/MIC and CMP/PWR. These knobs are all the same size and are held in place by a friction spring as shown in Figure 19. Align the flat in the knob with the flat on each shaft before pressing each knob in place. In addition to the rotating encoder, each knob has a switch that is actuated by pressing the knob toward the panel. You will feel the switch action when you press each knob onto the shaft.

⚠ If a knob feels very loose, check to see if the metal friction spring insert is in place as shown below. If not it should be in the bag with the knobs. Slide the spring insert into the knob and place it on the shaft. Friction will hold it and the knob securely once it is mounted.

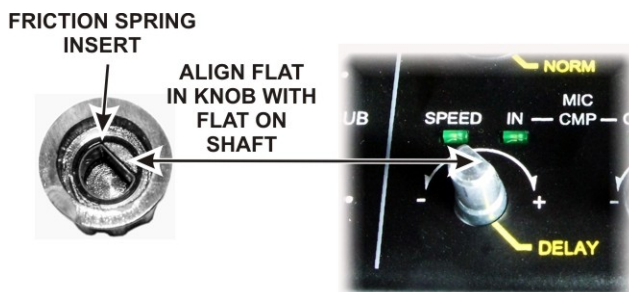

Figure 19. Mounting Friction Knobs.

In the same manner, mount the slightly larger friction knob onto the RIT/XIT control in the lower right corner of the front panel. The RIT/XIT control does not have the switch action of the other four encoders.

Mount the large knob on the VFO A encoder shaft below the LCD as shown in Figure 20. Adjust the position of the knob against the felt washer to produce the desired amount of drag for smooth movement without the knob turning too freely. Setting the panel face up and then placing the knob on the shaft so its weight determines the pressure against the felt usually produces a satisfactory amount of friction. If you want to make further adjustment and find it too sensitive, try a second felt washer under the knob. An extra felt washer is included in the kit for this purpose. You can do this after assembly is completed. The finger grip slides off to provide access to the set screw.



Figure 20. Mounting the VFO A Tuning Knob.

Mount the last knob on the VFO B encoder shaft to the right (under the pushbutton switches) as shown in Figure 21. Before tightening both set screws, adjust the position of the knob against the felt washer to produce the desired amount of drag for smooth movement without the knob turning too freely.

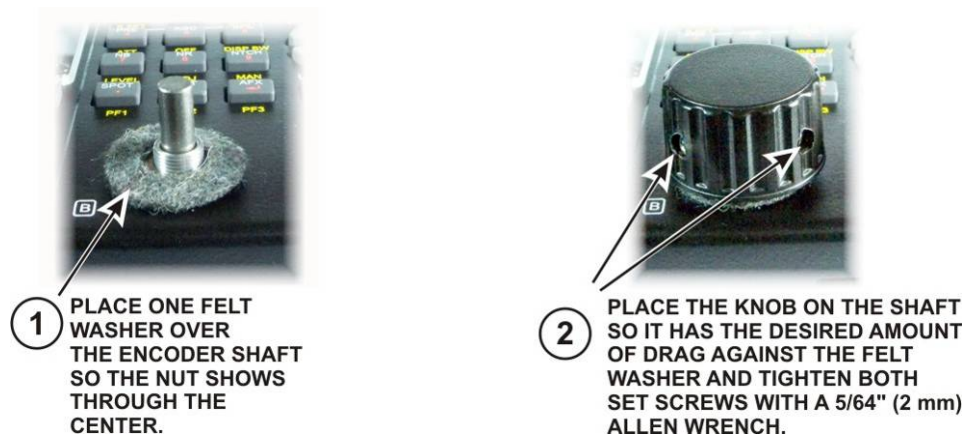

Figure 21. Mounting the VFO B Knob.

Mounting the Sub Receiver Auxiliary DSP Board

If you purchased the optional KRX3A sub receiver with your K3S, install the KXR3 auxiliary DSP board as follows. If you did not purchase the KRX3A, go to *Installing the KDVR3 Digital Voice Recorder Option* on page 25 if you purchased the KDVR3 Digital Voice Recorder Option with your K3S. If you do not have the KDVR3, go directly to *Mounting the DSP Board Assembly on the Front Panel* on page 26.

The parts called for in the following procedure are included in the KRX3A sub receiver kit. Install only the Auxiliary DSP board as described in the following steps. You will complete the KRX3A installation after the basic K3S is assembled, calibrated and tested.

If your KRX3A kit was supplied with 1/4" (6.4mm) long nylon screws, skip this step. If you have 1/2" (13mm) nylon screws, cut all three of them to length as follows:

- Screw three 4-40 nuts onto the 1/2" (13 mm) 4-40 nylon screw as shown in Figure 22.
- Cut off the nylon screw flush with the last nut. Sharp diagonal cutters or a knife will cut the nylon.
- After cutting, remove all three nuts. (The nuts establish the correct length for the screw and "clean up" the thread where you cut the screw.)

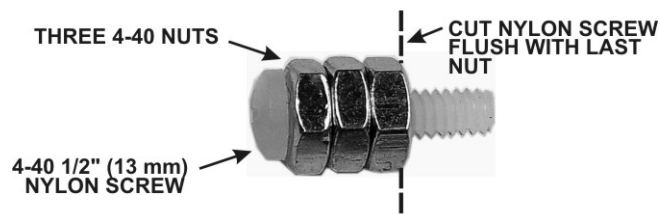

Figure 22. Preparing the Nylon Screw.

□ Mount the three 7/16" (11mm) male/female standoffs on the component side of the *main* DSP board as shown in Figure 23 using 4-40 nuts and #4 split lock washers. Be sure that:

- The standoffs are on the component side of the board as shown.
- No lock washer is used between the standoff and the board.
- One split lock washer is used between the nut and the board.

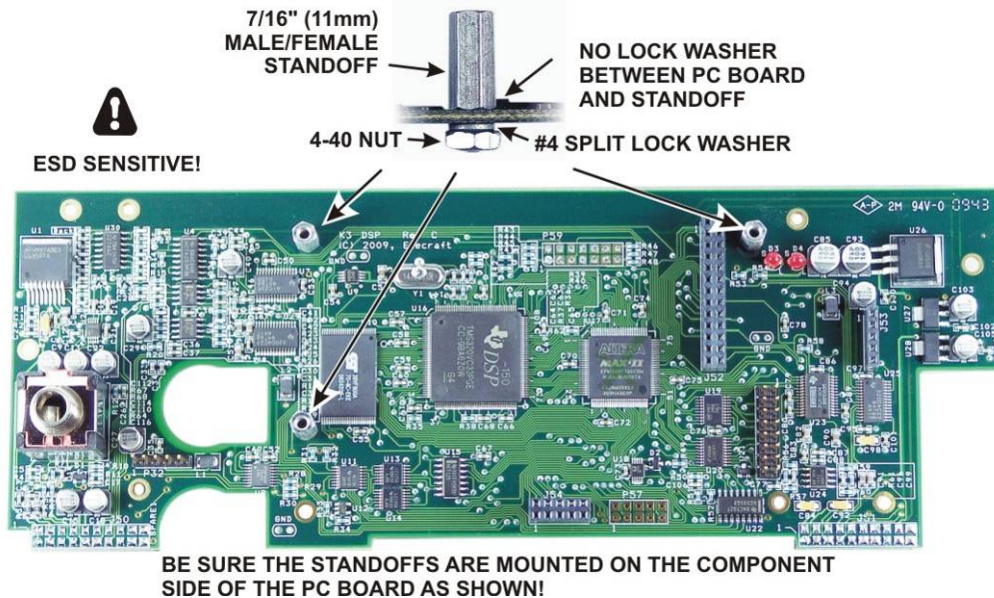

Figure 23. Installing Standoffs on the Main DSP Board.

□ Plug the aux DSP board into the main DSP board by mating P52 and P53 on the aux DSP board (at the narrow end) with J52 and J53 on the main DSP board. When fully seated, the connectors should be fully engaged so that the pins do not show and the aux DSP board should rest against the top of the standoffs with the holes in the board aligned for the screws (See Figure 24). Note that a two-row 10-pin connector at the top of the aux DSP board does not mate with anything on the main DSP board. That is normal. Attach the boards with three 4-40 1/4" (6.4 mm) *nylon* screws or the nylon screws you trimmed to length earlier (see Figure 22). Place a split lock washer under each screw head. Do not place washers between the standoff and the pc board. **Be careful tightening the nylon screws. They are easily stripped!**

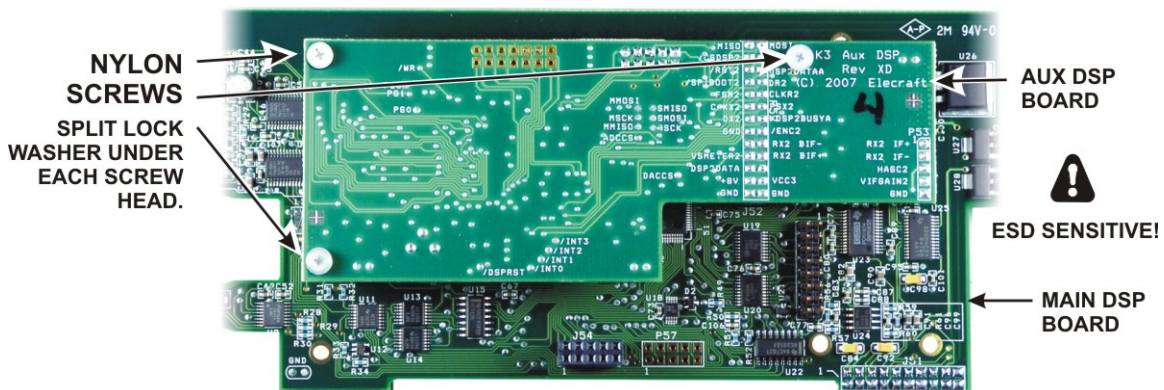

Figure 24. Mating the Main and Auxiliary DSP Boards.

☐ Locate resistor R3 on the front panel board (mounted on the front panel). If R3 is positioned above the board on its leads as shown in Figure 25, push it over to one side of the outline as shown. Be sure you don't push it so far its leads might touch the solder pads for other components on the board.

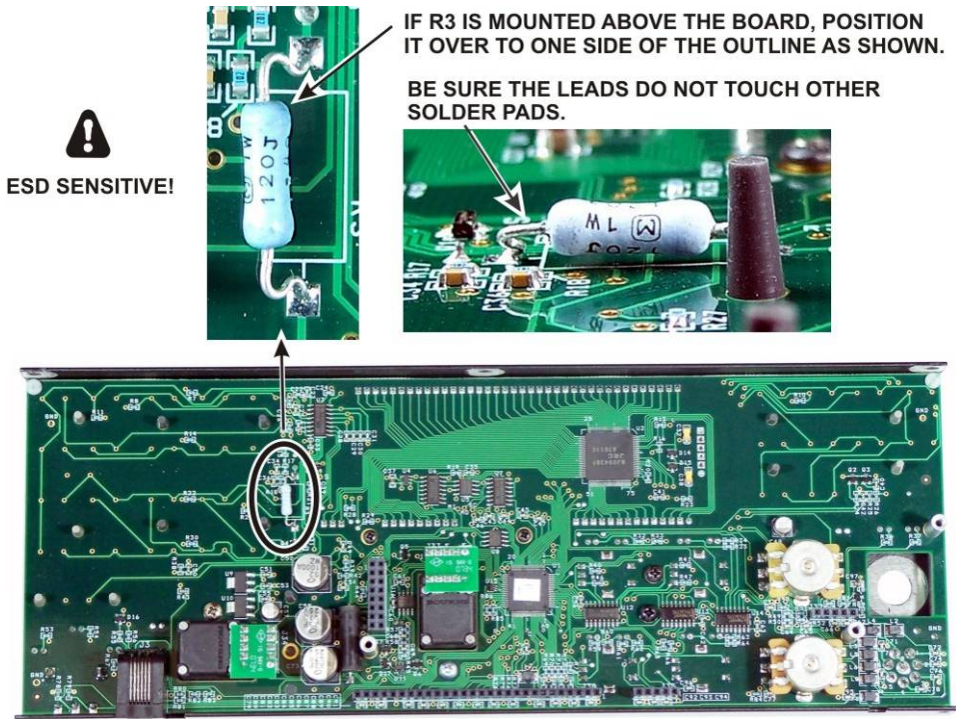

Figure 25. Positioning R3 on the Front Panel Board.

Installing the KDVR3 Digital Voice Recorder Option

☐ If you have the KDVR3, install it on the main DSP board as shown in Figure 26. The required hardware is included in your KDVR3 kit. If you did not purchase the KDVR3, skip this step and continue with *Mounting the DSP Board Assembly on the Front Panel* on page 26.

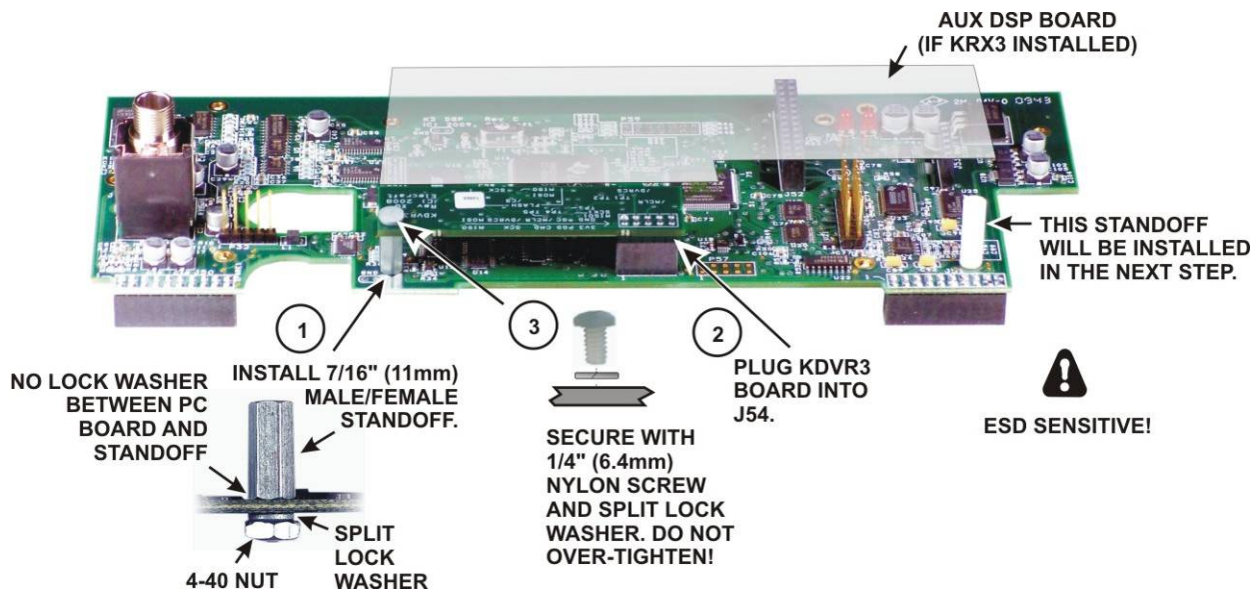
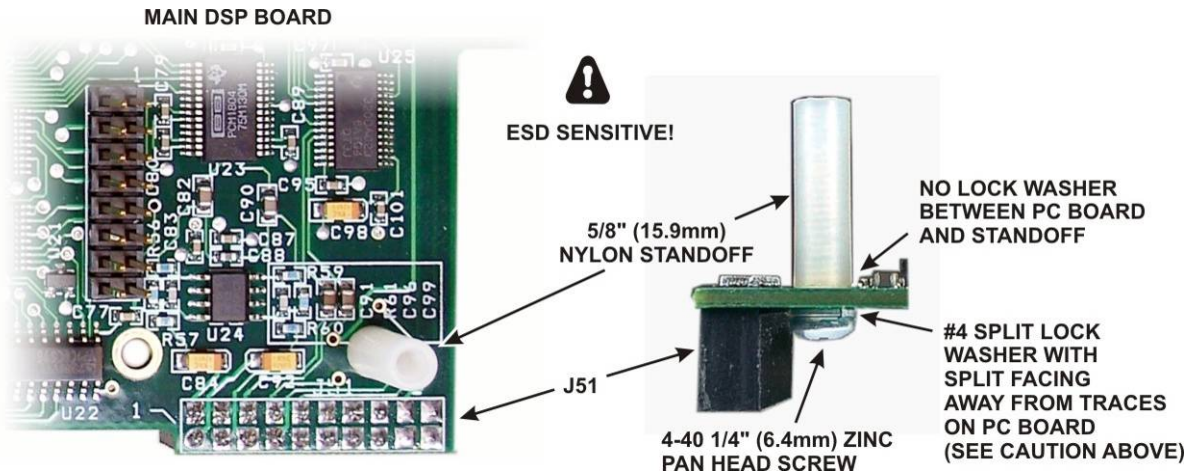

Figure 26. Installing the KDVR3 Board.

Mounting the DSP Board Assembly on the Front Panel

- Locate the main DSP board and install the nylon standoff near J51 as shown below. Be sure you place it in the correct hole near the edge of the board. The standoff is also shown in Figure 26.

⚠ CAUTION: To avoid damaging a circuit trace very close to the metal ring around the screw hole, position the lock washer under the screw so the split faces away from the trace. Tighten the hardware by turning the standoff while holding the screw and lock washer stationary. *Do not over-tighten the screw. It is easy to strip the threads in the nylon standoff.*



- Place the front panel assembly face down on a soft, clean surface to protect the finish. The back side of the front panel board should be facing upward.
- Position the large flat washer on the inside of the front panel over the PHONES jack hole (see Figure 30 on page 28). This is easily done by sliding the washer into place from the end of the front panel.
- Gently position the DSP board on the front panel board so that the large jack fits through the cutout in the front panel board with the threaded section passing through the large flat washer and the circular opening in the front panel. Adjust the position of the board as needed so you can see the standoffs on the front panel board lined up with the screw holes in the DSP board.
- Pick up the assembly while holding the DSP board in place and inspect the position of the two male plugs on the DSP board. They should mate with J31 and J32 on the front panel board. J31 is near the encoder for VFO A and J32 is between the two dual potentiometers. Adjust the DSP board's position as needed so the pins enter the corresponding holes in the sockets on the front panel board.

⚠ Use a strong light to look between the boards to be sure the connectors are properly mated. Be especially careful to check the connector near the dual potentiometers. Be sure the pins are entering the socket and not resting alongside it.

□ Squeeze the boards together while ensuring the pins are mating with the connectors until the DSP board is resting against the three standoffs on the back of the front panel board that you installed earlier. The two connectors will not mate completely. About 1/4" (6.4mm) of the pins may be visible when the DSP board is positioned against the standoffs. There are other connectors on the DSP board as well, but the two that mate with J31 and J32 are the only ones that connect between the front panel and DSP boards.

□ If you installed the Auxiliary DSP board for the KRX3A and adjusted the position of resistor R3 as shown in Figure 25, look between the DSP boards and the front panel board to verify that the leads are not touching any terminals on either the aux DSP or front panel boards (see Figure 28). If necessary, unplug the DSP board assembly and adjust the position of R3 to ensure the leads are clear of other solder pads before proceeding.

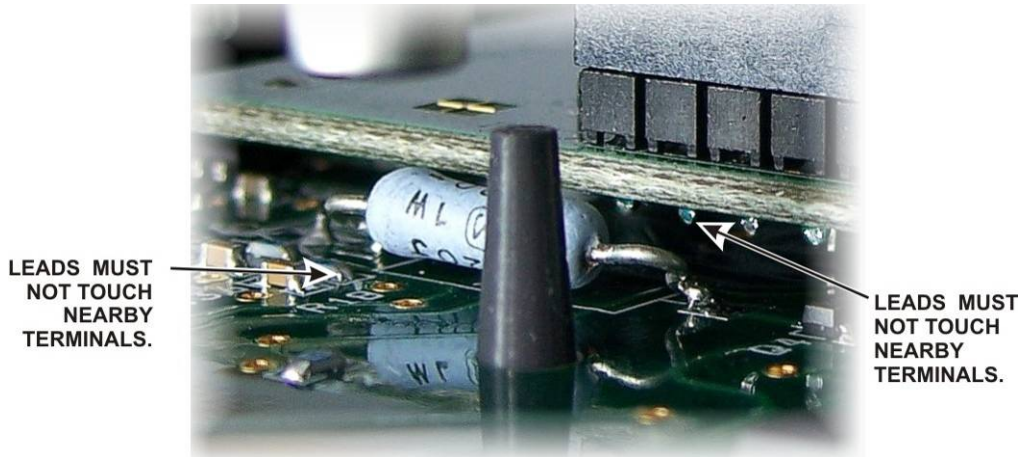

Figure 28. Checking the Position of R3.

□ Secure the DSP board to the front panel board with three 4-40 1/4" (6.4 mm) zinc pan head screws and split lock washers as shown in Figure 29.

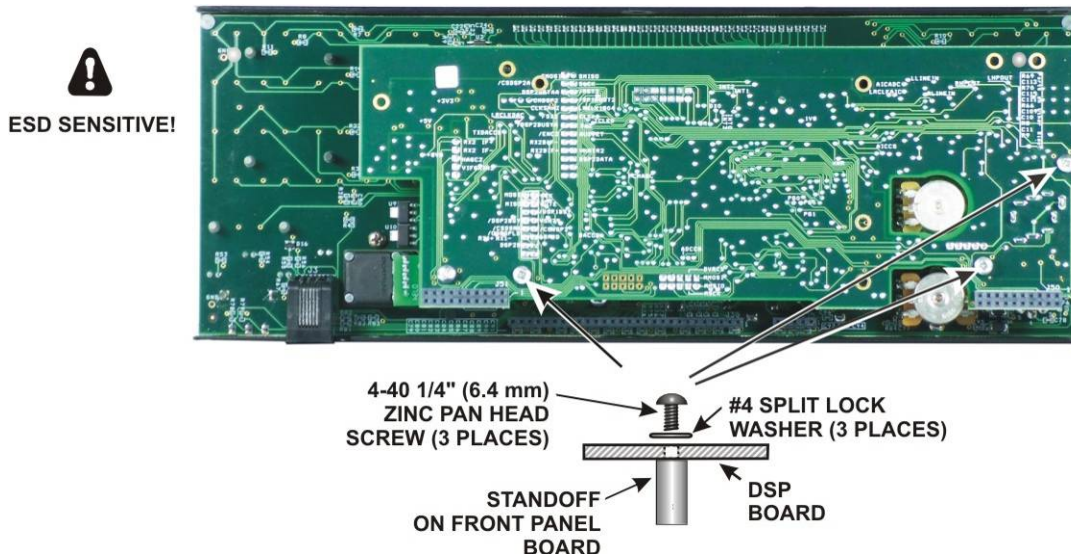

Figure 29. Mounting the DSP Board.

- Screw the knurled nut onto the threaded shaft of the PHONES jack where it exits the front panel (see Figure 30). Screw it only finger tight. Do not use pliers.

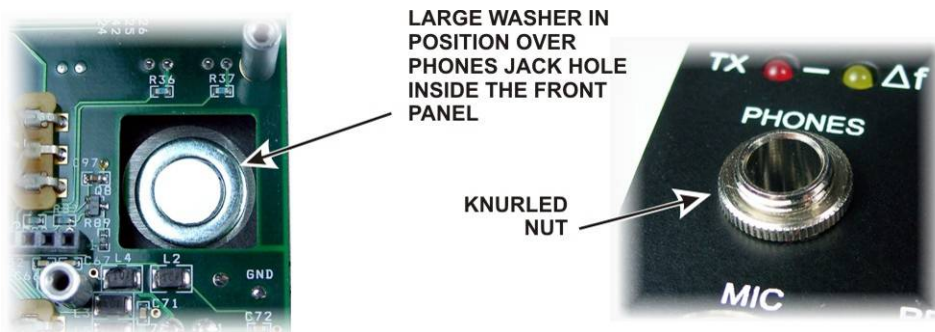

Figure 30. Phones Jack Hardware.

- Set the front panel assembly aside in a safe place while you assemble the RF board and chassis.

RF Board and Chassis

RF Board Description

The RF board is the heart of the K3S transceiver, both physically and electrically, providing signal routing to and from all modules. During assembly, it serves as an attachment point for other boards as well as the chassis panels, acting as the central element that holds things together. For more information, see *Theory of Operation, RF Board*, in the K3S Owner's Manual.

A partially assembled RF board is shown in Figure 31. It is provided to help you locate where the various parts are attached in the following steps.



ESD SENSITIVE!

WEAR A GROUNDED WRIST STRAP OR TOUCH AN UNPAINTED METAL GROUND BEFORE HANDLING THE RF BOARD.

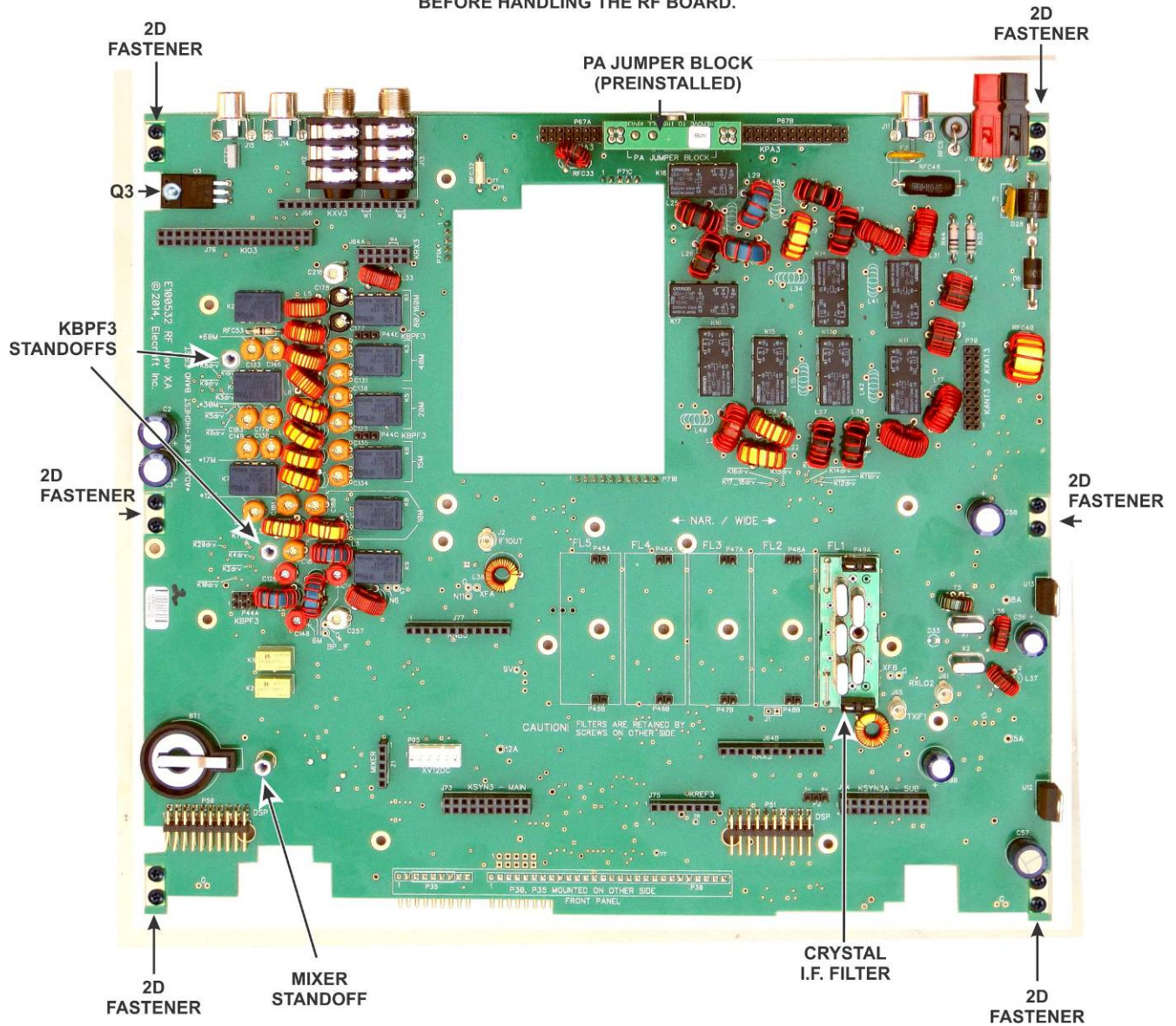

Figure 31. RF Board Partially Assembled.

RF Board and Chassis Assembly

⚠ CAUTION

There are components on both sides of the circuit boards. When handling them, be careful not to damage components on either side by placing the board on top of tools or other objects, or bumping or crushing the components while mounting parts or installing the boards

☐ Remove the RF board from its anti-static packaging. The top side of the board is the side with the toroid inductors and relays along with other components, including several connectors along one edge. The edge with the connectors is the back edge of the board, while the front edge has notches cut in it that will fit around front panel controls. Locate the six rectangular bare copper pads for the 2D fasteners (see Figure 32). There is one in each corner of the board and one in the center of each side (see Figure 31 on page 29).

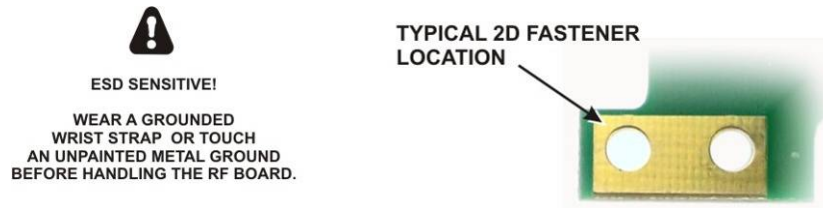

Figure 32. 2D Fastener Location on RF Board.

☐ Install 2D fasteners at the six spaces provided (one at each corner and at the center of each side of the RF board, see Figure 31). Mount the fasteners on the *bottom* side of the board as shown in Figure 33. Be sure the 2D fasteners are oriented so the side of each fastener lines up with the edge of the RF board as shown.

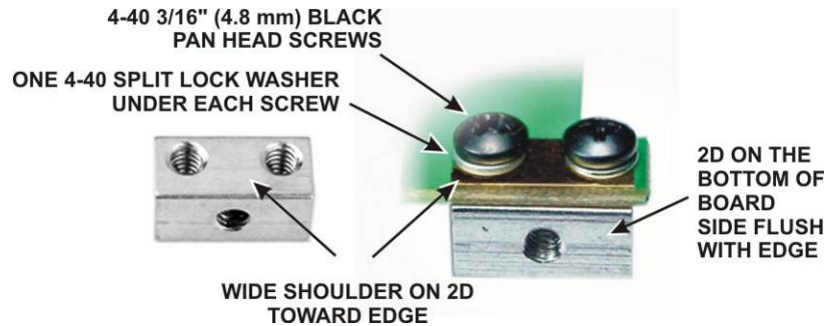

Figure 33. Installing 2D Fasteners on RF Board.

☐ Install a 4-40 3/8" (9.5 mm) standoff on the RF board near connector Z1 and battery holder BT1 as shown in below. This standoff will support the mixer to be installed later. Install the standoff using *three* lock washers as shown below with two of the lock washers between the standoff and the RF board.

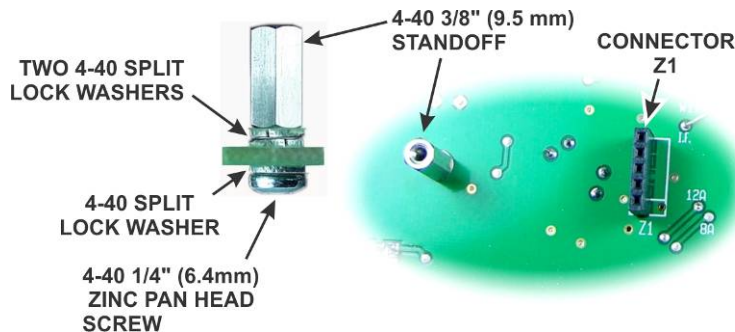

Figure 34. Installing Mixer Standoff.

Install the two KBPF3A standoffs shown in Figure 35. Even if you didn't purchase the KBPF3A general coverage option, the standoffs and hardware are included in the K3S kit to make installing the option easier at some future date. Note that these standoffs have only *one* lock washer between each standoff and the RF board

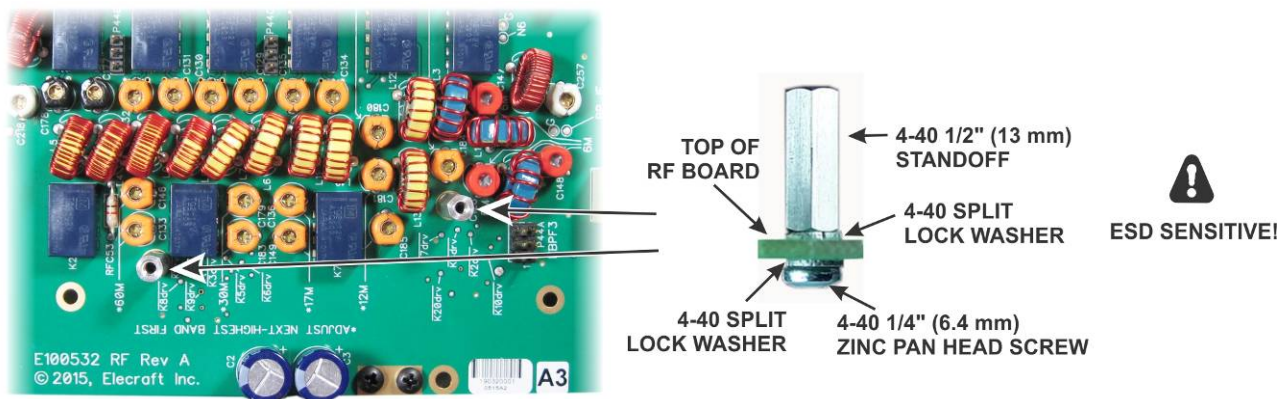

Figure 35. Installing KBPF3A Standoffs.

Install hardware to attach Q3 to the RF board near the rear left corner as shown in Figure 36 and Figure 31 on page 29.

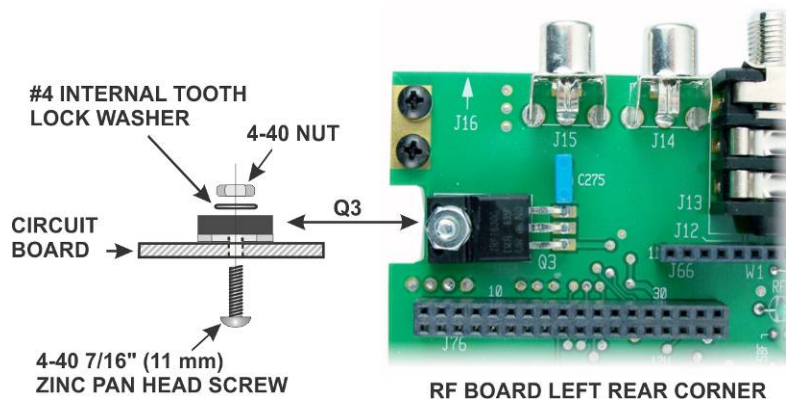

Figure 36. Installing Q3 Hardware.

Installing the Crystal (Roofing) Filters

Locate the crystal I.F. filter(s) that you purchased with the K3S. At least one I.F. filter must be installed for the K3S to operate. Two types of filters are available: standard 5-pole filters and optional 8-pole filters (see Figure 37). If you plan to add filters later, spaces may be left for them. For example, if you plan to add the FM or a 6 kHz AM filter later, you can leave spaces FL1 and FL2 open for them and install the 2.8 kHz filter in position FL3. The filters are not hard to move about later, so if you aren't sure, install the widest at FL1, the next widest at FL2 and so on.

Enter the following data on Table 1. You will need this information to set up your filters after assembling your K3S. Be sure you're following the rule described in the step above about the proper order for the filters. Note that Table 1 is set up with FL1 to the right and FL5 to the left, just as they must be installed on the RF board.

- Enter the bandwidth of each filter in the row below the filter position in which it will be installed.

- Enter the **FREQ OFFSET** shown on each filter. The optional 8-pole filters have no offset marked on them. Enter a zero in the **FREQ OFFSET** column for those filters. **For the 5-pole filters, note that the frequency offset may be *negative*, indicated by a minus sign (single dash) ahead of the number.**

Table 1. Filters Installed.

Note: FL1 is to the right and FL5 is to the left. In the next step you will install the filters right-to-left on the RF board as well.

POSITION	FL5	FL4	FL3	FL2	FL1 ¹
BANDWIDTH ²					
FREQ OFFSET ³					

1. If you're installing the KFL3B FM filter, place it in FL1 position since it is the widest bandwidth filter available.
2. The bandwidth is shown in the label attached to the filters except the K-FL3B FM filter. Record a bandwidth of 13 kHz for the KFL3B FM filter.
3. All of the optional 8-pole filters have an offset of zero. Note that the 5-pole filters may have a negative offset, indicated by a minus sign ahead of the number.

Install the filters as shown in Figure 37. Refer to the list of filters you created in Table 1 to determine which filter to install at each location.

⚠ CAUTION

1) Do not use screws longer than 1/4" (6.4 mm) to mount the filters. Use your ruler to measure the screws before installing them. Longer screws may extend into the optional 8-pole filter and destroy it. We strongly recommend you use a 1/4" screw even when installing the 5-pole filters to reduce the possibility of damaging an 8-pole filter should you change them later.

2) Do not over-tighten the screws. Too much torque may pull the threaded bushing out of the bottom of the filter module.

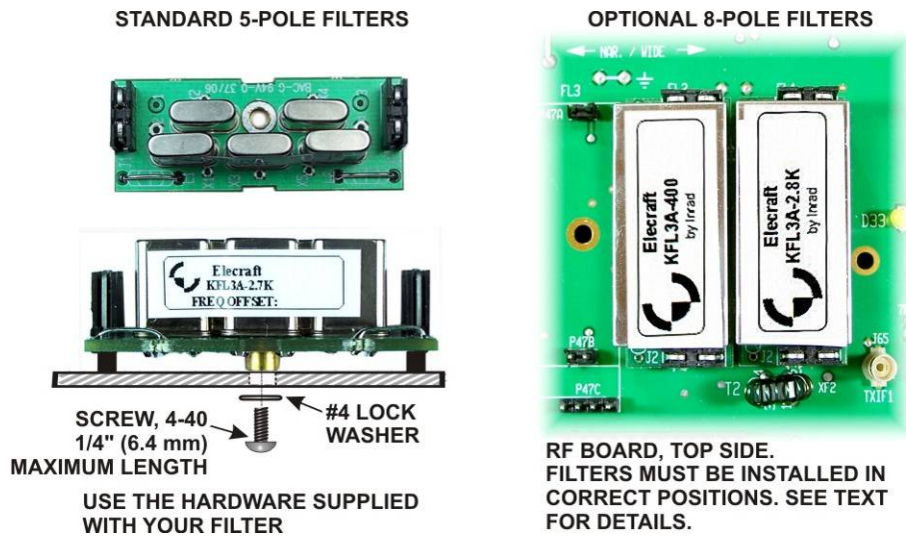

Figure 37. Installing Crystal I.F. Filters.

Locate the K3S top cover. On the inside is a label with places to record the bandwidth (BW), and frequency offset (FRQ) of each filter. Copy the information from Table 1 and place a check mark by Main (for main receiver) on the label. Use pencil in case you change your filters later. This will keep the filter information with your K3S. The label also has a row for Gain. This is a value you can determine later after your K3S is assembled and aligned. It is a value set in MENU to adjust the overall gain for each roofing filter so the audio remains constant when switching from one filter to another. Making this adjustment is described under *Filter Loss Compensation* in your owner's manual.

Set the top cover aside until it is installed later.

Installing the Low Power Amplifier (KLPA3A)

Install the Low Power Amplifier (KLPA3A) board in the cutout on the RF board as shown in Figure 38. The board is held in place by its connectors until the bottom cover is installed.

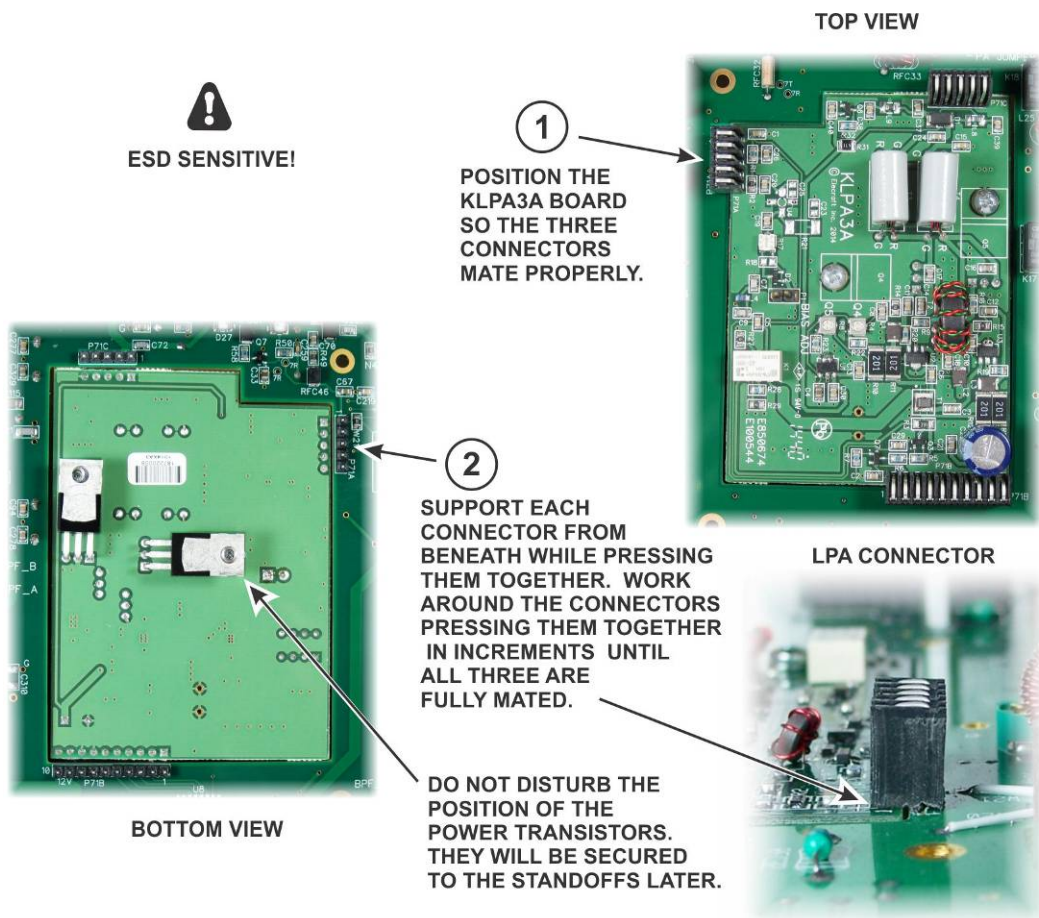

Figure 38. Installing the KLPA3A Low Power Amplifier.

Check all three KLPA3A connectors shown in Figure 38 to ensure they are fully mated as shown. If they are not fully mated, the transistors will not rest against the K3S bottom cover as required when it is fitted later.

Installing the Front Panel Shield

□ Mount a 2D fastener on each ear of the front panel shield, and then mount the shield on the RF board as shown in Figure 39. Be sure the 2D fasteners are oriented with the widest part between the two holes and the edge toward the outside as shown.

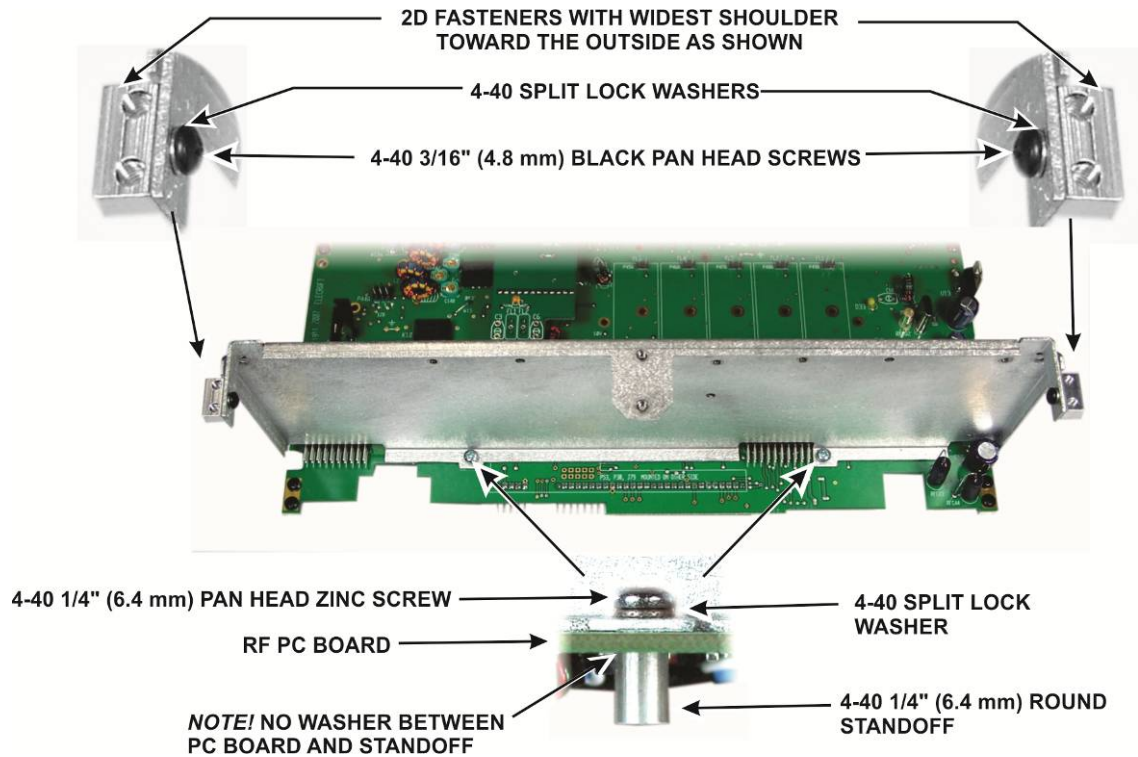

Figure 39. Installing Front Panel Shield.

Installing the Mixer

□ Mount the K3S mixer board on the RF board as shown in Figure 40. The mixer plugs into Z1 on the RF board.

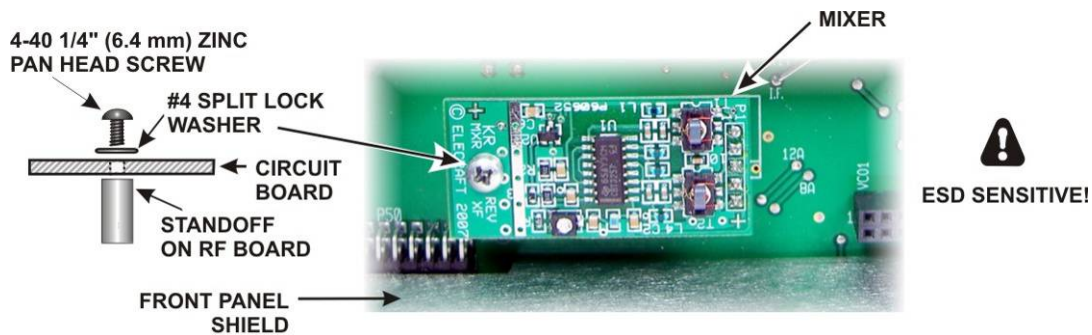

Figure 40. Installing Mixer Board.

Installing the KXV3B Interface Module

The KXV3B Interface provides a separate receive antenna input and output, inputs and outputs for use with an external transverter, and a buffered i.f. output. Also included is a high-gain, low-noise preamplifier that provides extra sensitivity on the 12 through 6 meter bands. Complete details for using the KXV3B are included in the K3S Owner's manual.

- Inspect the connector on the RF board marked KXV3B. It may have two white jumpers across some of the pins that were installed at the factory to test the board. If present, remove them.
- Plug the KXV3B module into the KXV3B connector as shown in Figure 41 with the BNC connectors on the module facing toward the rear of the RF board. Note that the pins do not fully engage. That is normal.

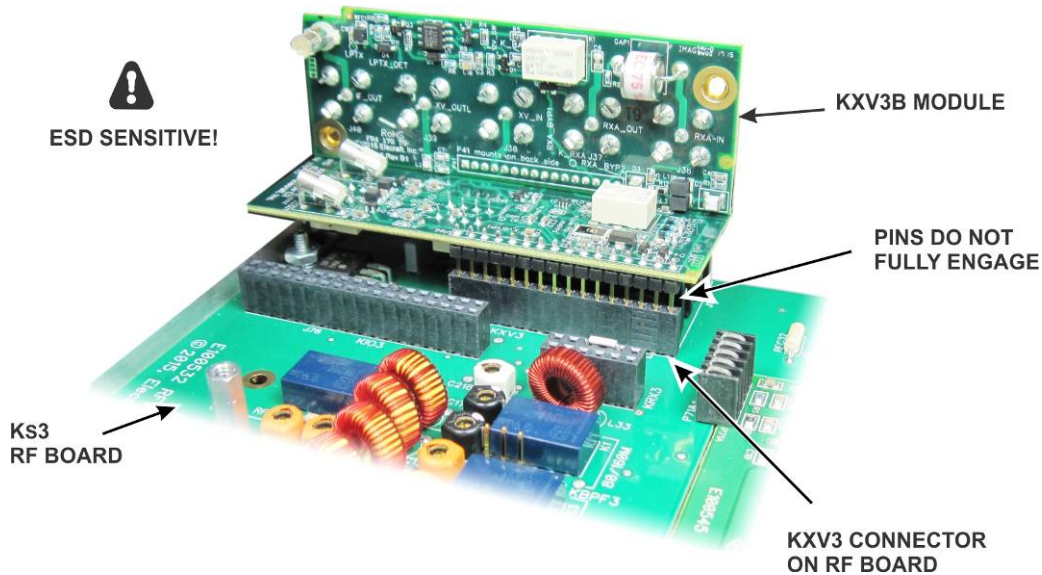

Figure 41. Plugging the KXV3B Module into the RF Board.

Installing the Rear Panel

- Locate the K3S rear panel and inspect the inside surface for masking tape around the connector and screw holes as shown in Figure 42. Note that there are three screw holes on the top lip and two on the bottom lip that must be clear as well.

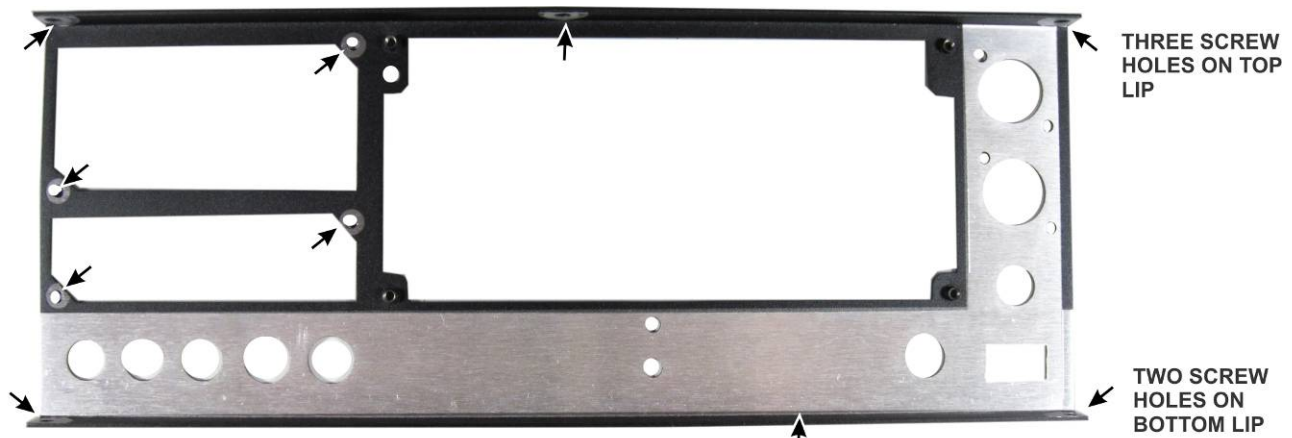

Figure 42. Checking Rear Panel for Masking Tape.

Peel the backing from the self-adhesive serial number label and attach it to the outside surface of the back panel as shown in Figure 43. You may wait until the assembly is finished before attaching the serial number, but at this point you can lay the panel flat on the work surface to easily position the label square within the outline.

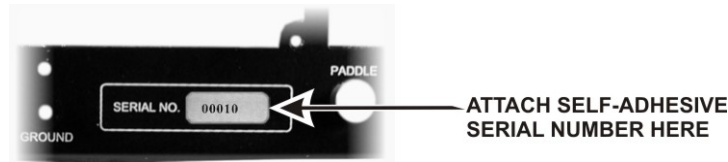

Figure 43. Attaching Serial Number.

Installing Antenna Connectors on the Rear Panel.

Mount an SO239 connector in the ANT1 position on the rear panel using two 4-40 1/4" (6.4 mm) black pan head screws (SS), two 4-40 internal tooth lock washers and two 4-40 nuts as shown in Figure 64. The flange of the SO239 connector is on the inside (unpainted side) of the rear panel.

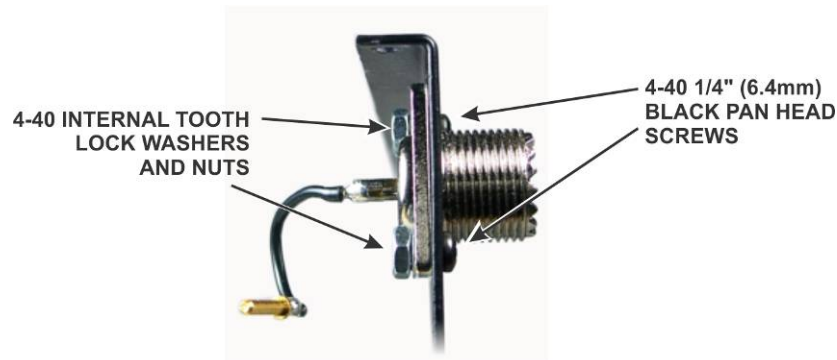

Figure 44. Mounting the ANT1 Connector.

If purchased the optional KAT3A automatic antenna tuner with your K3S you will have another SO-239 connector. Install the second SO239 connector in the ANT2 position on the rear panel using two 4-40 1/4" (6.4 mm) black pan head screws (SS), two 4-40 internal tooth lock washers and two 4-40 nuts just as you did for the ANT1 connector. Set the rear panel aside for now.

Installing the KRX3A Auxiliary Antenna Connector on the Rear Panel

If you do not have the KRX3 sub receiver option kit on hand, skip this section and go directly to *Installing the K3EXREF SMA Connector* on page 38 to continue assembly.

If you have the KRX3A sub receiver option kit on hand, you may wish to install the AUX RF antenna connector at this time. The AUX RF connector is one optional way to connect an antenna to the sub receiver. Before you decide, turn to your *KRX3A Installation and Operation Manual* and review the *Auxiliary KRX3A Antenna Input (Optional)* section. It is not necessary to install the connector now, even if you decide to use it. Complete instructions for installing it later are included in your KRX3A manual.

If you wish to install the AUX RF connector now, do so as follows.

- Retrieve the following components from your KRX3A sub receiver kit:
- Coaxial cable with a pre-mounted BNC female panel connector on one end and a TMP connector on the other end (TMP connectors are shown in Figure 83 on page 58).
 - Nut and internal tooth lock washer that fits the BNC connector. (They may be supplied threaded onto the connector. If so, remove them.)

- One 4-40 3/8" (9.5 mm) black pan head screw.
- One #4 internal tooth lock washer.
- One 4-40 nut.

The highly scratch-resistant powder coating on the rear panel may interfere with the fit of the BNC connector through the hole. Remove the coating around the edge of the hole using a hobby knife or other sharp tool (see Figure 45). Note that the hole is flat at the top. That is intentional.

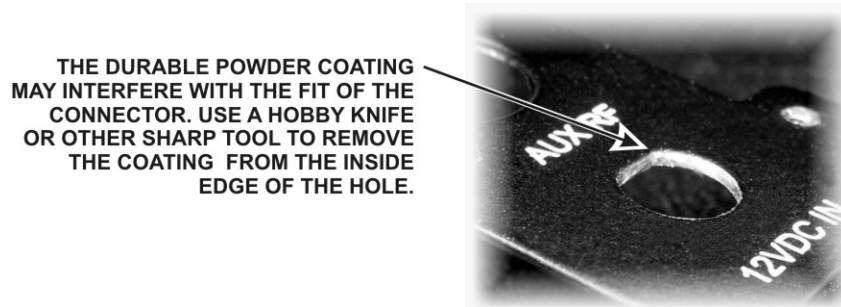

Figure 45. Removing the Powder Coating from the AUX RF Connector Hole.

Thread the BNC/TMP cable through the AUX RF connector hole from the outside, lining up the flat on the threaded section of the connector with the flat at the top of the hole. Slide the lock washer and nut onto the cable. Fold the solder lug on the braid down against the coax to fit through the back panel hole, the lock washer and the nut. Thread the nut onto the connector and tighten it (see Figure 46).

Mount the solder lug attached to the braid as shown in Figure 46, using a 4-40 3/8" (9.5mm) black pan head screw, #4 internal tooth lock washer and 4-40 nut. If you have the KAT3A option, there will be a shorter screw holding the connector flange. Replace it with the 3/8" (9.5 mm) screw. If you do not have a KAT3A, there will be no connector in the ANT2 hole. In that case, the solder lug is directly against the unpainted inside surface of the rear panel.

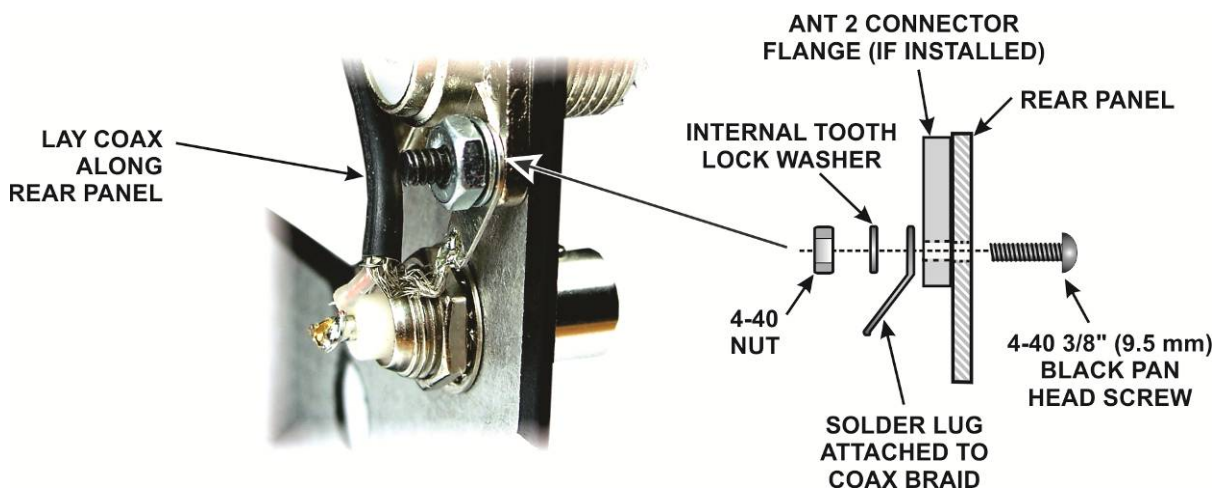

Figure 46. Installing the AUX RF Connector.

Carefully insulate the metal TMP connector, covering all of the metal parts with electrical tape or other suitable material that you can remove easily later.

⚠ CAUTION

Later you will apply power to do preliminary testing and calibration before the KRX3A sub receiver is installed. Failure to insulate the TMP connector as described above may result in short circuits and extensive damage to your K3S if it touches a component, solder pad or other exposed circuit points.

Installing the K3EXREF SMA Connector on the Rear Panel

If you do not have the K3EXREF option, skip the following and go directly to *Installing the Rear Panel* below.

Open your K3EXREF Option kit and retrieve the SMA-TMP cable and its associated hardware (see Figure 47).

Mount the SMA connector in the REF opening on the rear panel as shown in Figure 47.

⚠ Hold the connector so it cannot turn while tightening the nut on the outside of the rear panel so the connector cannot turn and stress the coaxial cable (see Figure 47).

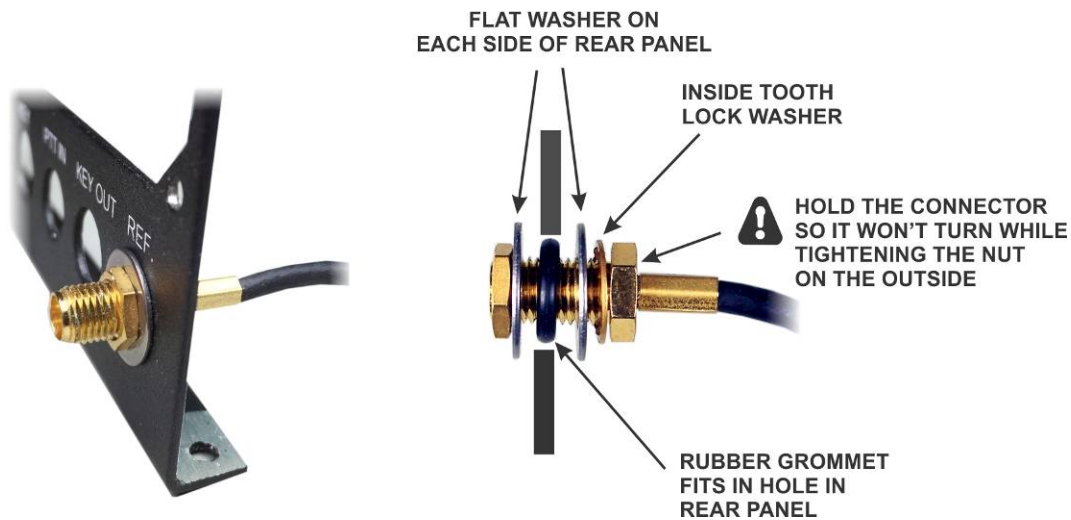

Figure 47. Mounting the K3EXREF SMA Connector.

Installing the Rear Panel

Install hole plugs in the unused rear panel connector openings as shown in Figure 48.

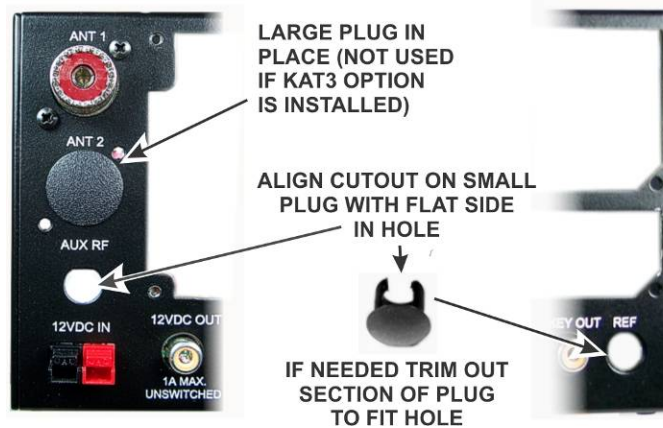

Figure 48. Installing Rear Panel Hole Plugs.

☐ Position the rear panel on the edge of the RF board opposite the front panel shield you installed earlier. The BNC connectors to the KXV3B module fit through the opening in the rear panel (see Figure 49). The lower lip of the rear panel goes under the 2D fasteners on the RF board. Secure the rear panel with the ground screw as shown. The ground screw threads into a fitting mounted on the edge of the RF board.



Figure 49. Mounting the Rear Panel.

☐ Turn the K3S over and secure the bottom lip of the rear panel to the 2D fasteners at the corners of the RF board with two 4-40, 3/16" (4.8 mm) black pan head screws (SS). (Note that all the screws used on the bottom of the K3S are black pan head screws.)

☐ Turn the K3S right side up and install the KXV3B panel as shown in Figure 50 using the hardware supplied in the KXV3B Hardware bag. Adjust the height of the KXV3B module in its connector as needed to line up the screw holes.

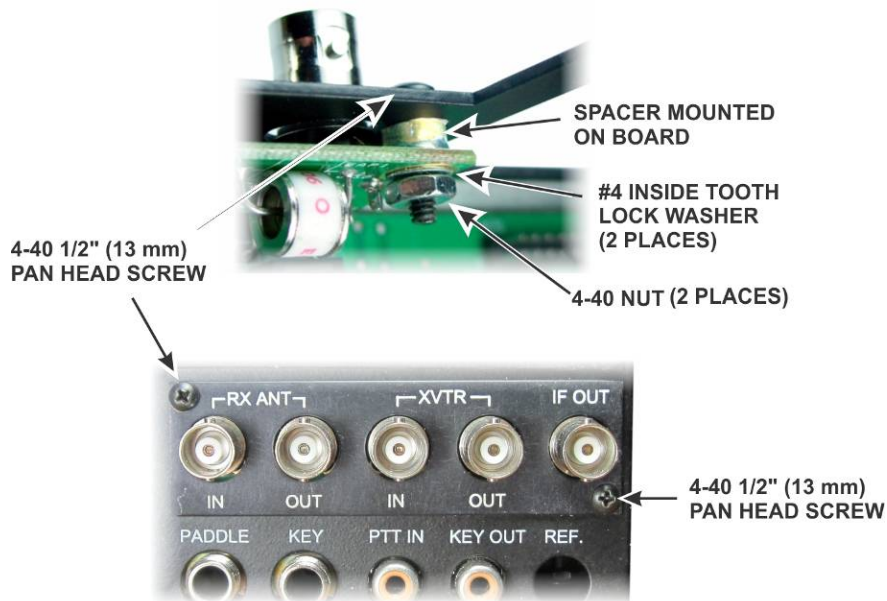

Figure 50. Installing the KXV3B Hardware.

Mount Front Panel Assembly on the Chassis

□ Turn the chassis upside down and position the front panel assembly so the pins of P30 and P35 on the bottom of the RF board just begin to engage the connectors on the lower edge of the front panel assembly (see Figure 64). Do not fully mate them yet.

POSITION THE FRONT PANEL ASSEMBLY SO THESE CONNECTORS BEGIN TO ENGAGE, BUT DO NOT TRY TO MATE THEM FULLY YET.

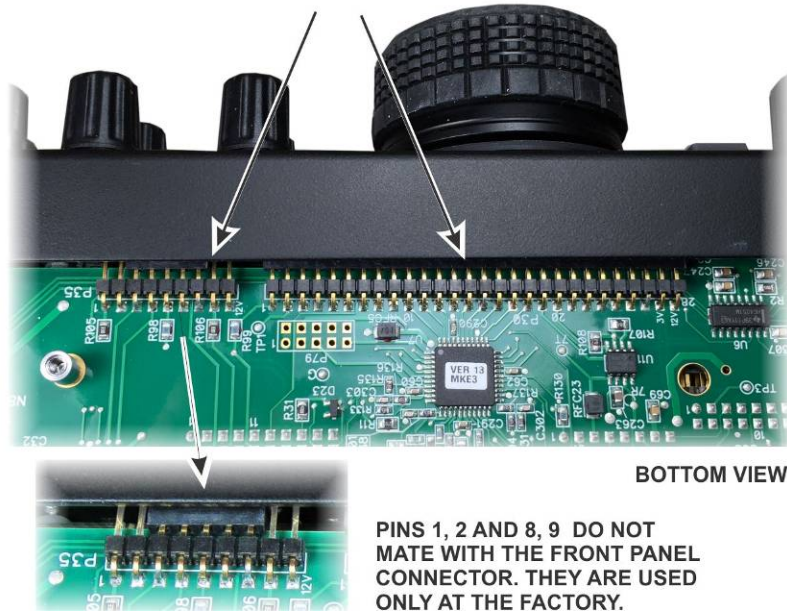

Figure 51. Mounting Front Panel Assembly - Connectors P30 and P35.

□ Look at the two multi-pin connectors on the top of the RF board to see if they are engaging the corresponding connectors on the front panel assembly (see Figure 52). Adjust the position of the RF board or the front panel assembly to ensure they are mating properly.

ADJUST POSITION OF FRONT PANEL AND RF BOARD SO THE PINS OF BOTH CONNECTORS ENGAGE

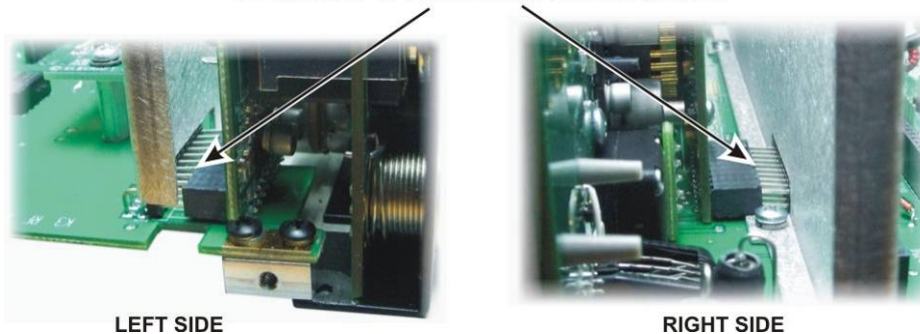

Figure 52. Mounting Front Panel Assembly - Connectors P50 and P51.

□ With the pins of all four connectors started, press the front panel onto the RF board connectors. Press only from the bottom of the front panel to avoid flexing the RF board. You can use your fingers to press on the back side of each multi-pin connector on the top of the RF board while holding the front panel to engage them. There may be small areas of pins showing even after they are mated. You will know they are properly mated when the screw holes on the bottom lip of the front panel assembly line up with the screw holes in the 2D fasteners on the bottom of the RF board.

Secure the front panel assembly at the bottom lip to the 2D fasteners at the forward edge of the RF board with two 4-40 3/16" (4.8 mm) black pan head screws (SS).

Turn the K3S right side up and secure the front panel assembly at the top lip to the 2D fasteners at each end of the front panel shield and at the threaded PEM nut at the center with three 4-40 3/16" (4.8 mm) black flat head screws (SS).

⚠ REMOVING THE FRONT PANEL: If you ever need to remove the front panel assembly, remove the five screws holding it to the chassis (three on the top lip and two on the bottom), and with the K3S upside down and use a screwdriver in the two pry slots provided as shown in Figure 53. Do not insert the screwdriver deep enough to strike components on the boards! Pry each end in short increments until the connectors separate. Either a blade (as shown) or Phillips screwdriver may be used.

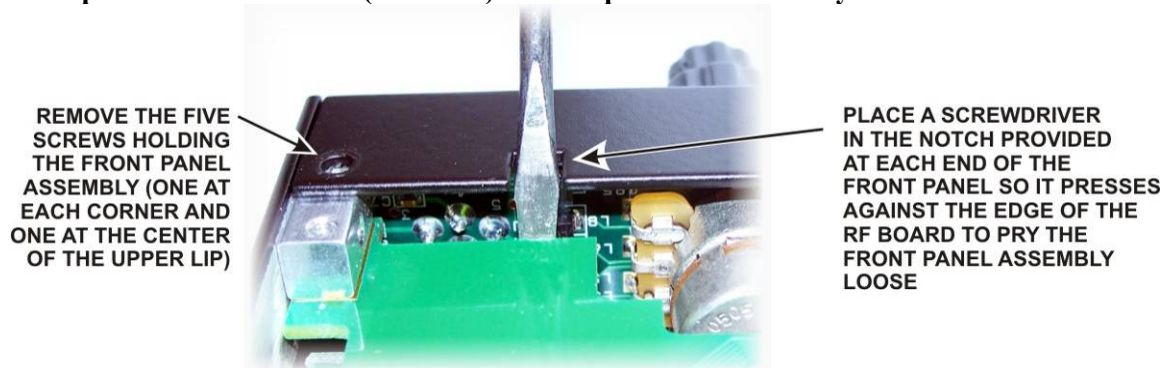

Figure 53. Removing the Front Panel.

Installing the KXV3B Interface Cable

Locate the coaxial cable with a TMP connector at one end and the white connector shown in Figure 54 at the other end.

The side of the white nylon connector nearest the connector holes must be smooth and flat. Use your diagonal cutters or a hobby knife to cut away any bumps or ridges (see Figure 54).



Figure 54. Preparing the KXV3B TMP Cable for Installation.

□ Plug the TMP coaxial connector into the KXV3B module and route the cable through the notch in the RF board as shown in Figure 55. If you have any difficulty, check the end of the cable for excess center conductor wires as shown in Figure 83 on page 58.

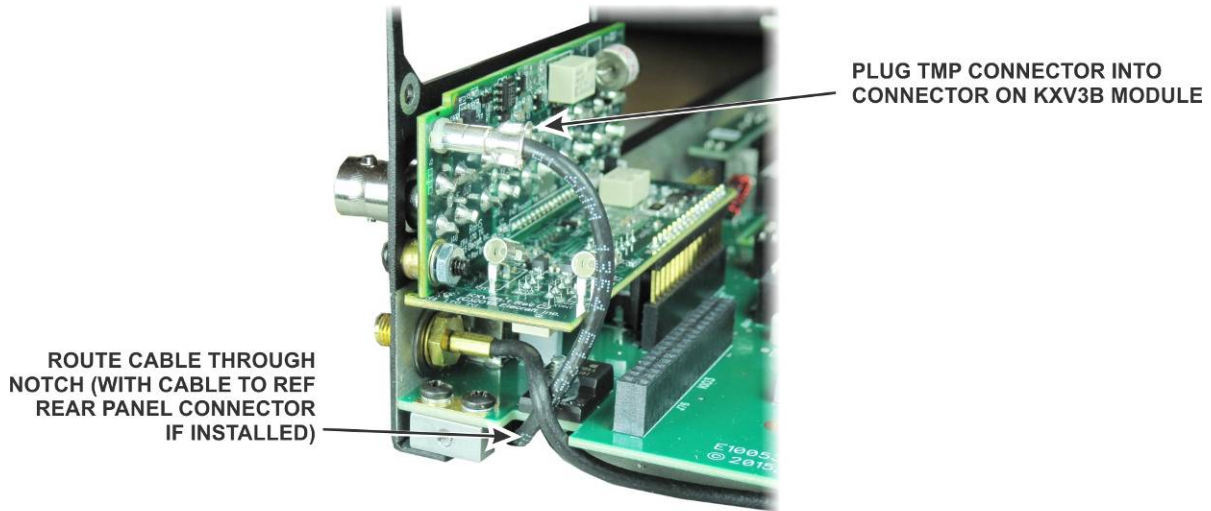

Figure 55. Connecting Coax Cable to KXV3B Module.

Installing the KIO3B Interface

All rear-panel audio and digital/computer I/O is routed through the KIO3B. The KIO3B is made up of three PC boards: Main, Audio I/O and Digital I/O. The Main KIO3B board plugs directly into the RF board, while the Audio and Digital I/O modules plug into the KIO3B main board. See *Theory of Operation, KIO3B*, in the K3S Owner's Manual for more information.

□ Mount two 1-1/4" (31.8 mm) standoffs in the two holes on the KIO3B board as shown in Figure 56 using a zinc 4-40 1/4" (6.4 mm) screw and internal tooth lock washer at each standoff. One is in the corner and the other is about half way down the opposite side of the board. ***Do not put lock washers between the standoffs and the board.***

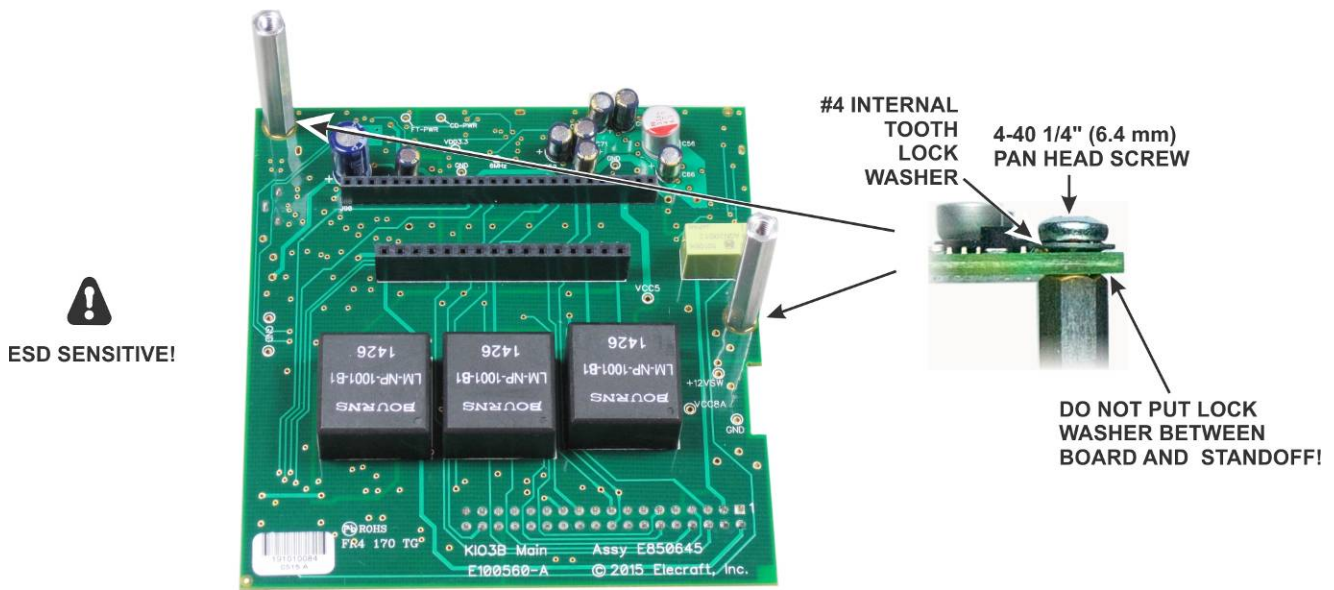

Figure 56. Mounting Standoffs on the KIO3B Main Board.

□ Plug the Audio I/O daughter board into J91 as shown in Figure 57. The second daughter board will be installed later.

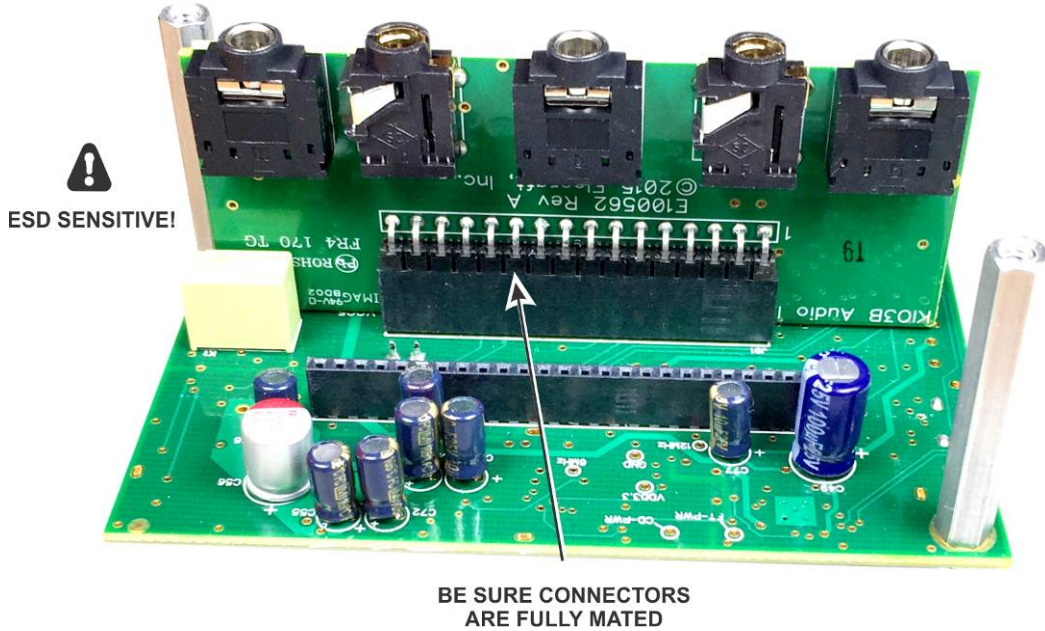

Figure 57. Mounting Audio I/O Daughter Board on KIO3B.

□ Install the KIO3B Main board with the Audio I/O daughter board attached into the K3S as shown in Figure 58. The KIO3B main board plugs into J76 on the RF board. The KXV3B coaxial TMP cable fits between the KXV3B and KIO3B boards. Ensure the connectors are fully mated so the standoffs line up with the screw holes on the rear panel.

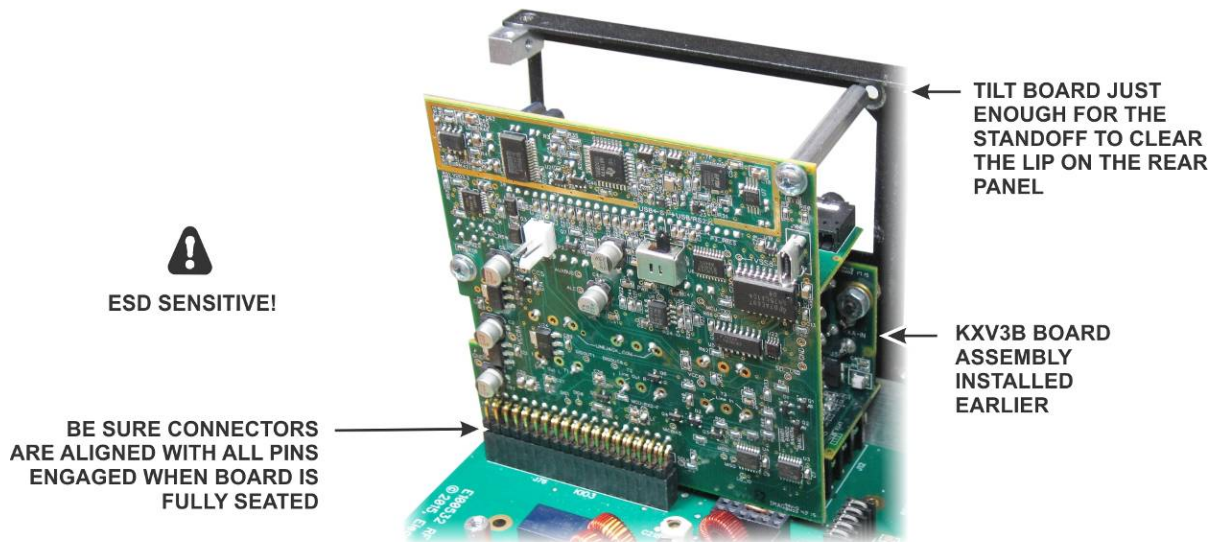

Figure 58. Installing KIO3B Main Board.

Turn the K3 so you can see the component side of the KIO3B main board and locate the USB/RS232 switch (see Figure 59). Place the switch in the USB/RS232 position as shown (toggle to the right looking at the switch).

⚠ This switch is used only in the unlikely circumstance in which you must force a firmware download using the USB port as described in your Owner's manual. It must be in the USB/RS232 position shown in the figure for normal operation.

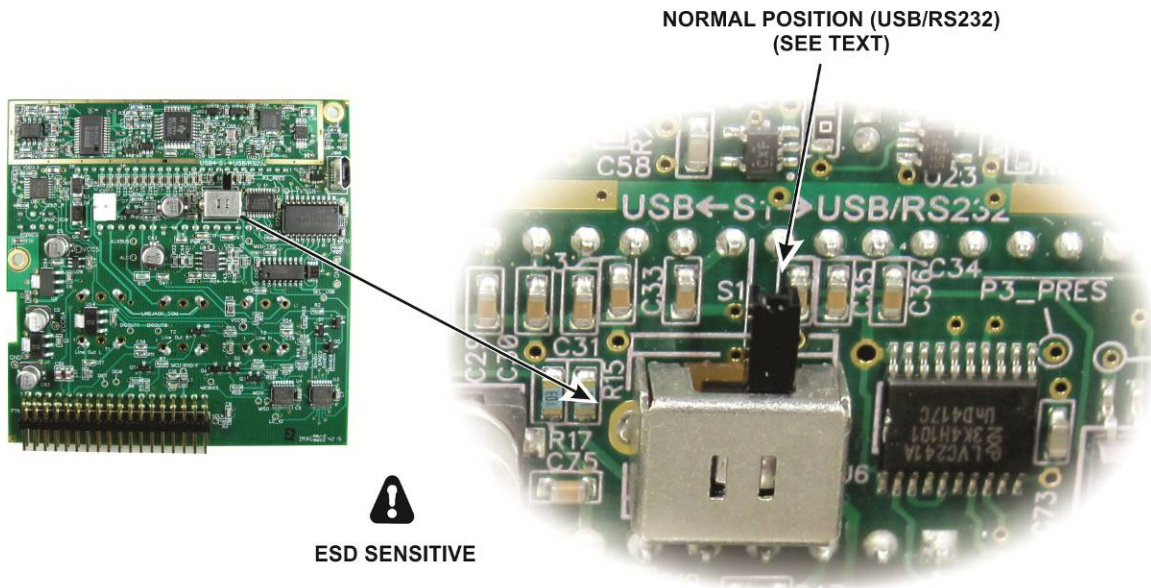

Figure 59. KIO3B Main Board USB/RS232 Switch.

The DE15 multi-pin connector on the KIO3B Digital I/O daughter board may have jackscrew nuts installed on the connector. (Jackscrew nuts are shown in Figure 61). If so, remove them. They will be reinstalled shortly.

Install the KIO3B Digital I/O daughter board as shown in Figure 60. Be careful to support the KIO3B main board as shown while pressing the daughter board in place.

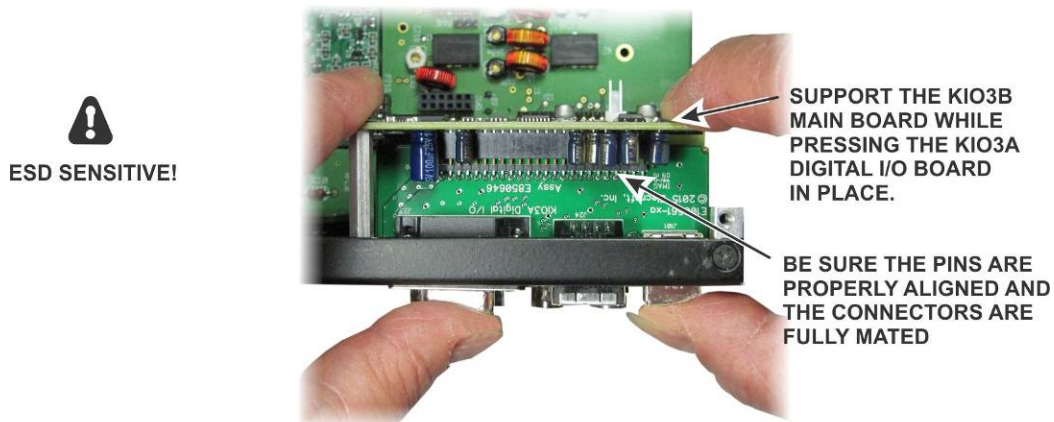

Figure 60. Installing the KIO3A Digital I/O Board.

Install the KIO3B rear panel as shown in Figure 61. Start with the pan head screw nearest the side panel. When it is started a few turns fit the panel over the connectors and align it to start screw in the opposite corner, then add the jack screw nuts. Start all of the fasteners before tightening any of them.

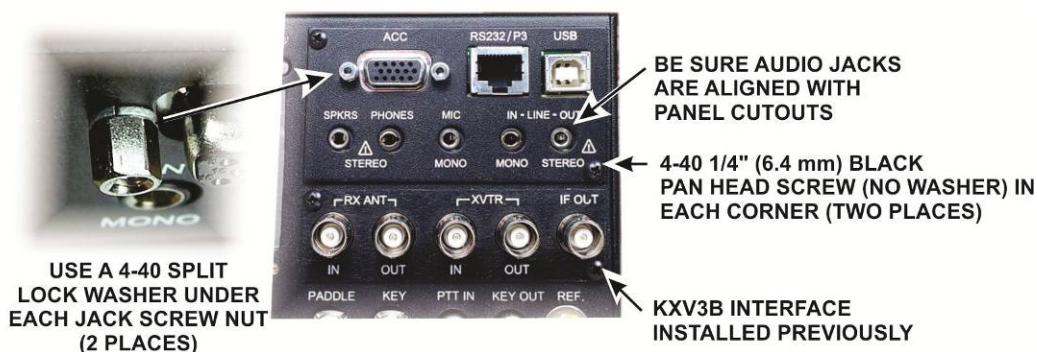

Figure 61. Mounting the KIO3B Connector Panel.

Installing Battery BT1

BT1 is a 3-volt lithium coin cell that provides the operating voltage for the real-time-clock IC (RTC) on the front panel when the K3S is turned off. Depending on the type of cell, BT1 could last from 2 to 10 years, thanks to the extremely low current drain of the RTC – on the order of a few microamperes. The RTC keeps track of the full date and 24-hour time, either of which can be displayed on the VFO B portion of the LCD.

The battery is installed on a holder mounted on the RF board near the left side panel (the panel with the handle attached) and the front panel shield.

Installing the battery has been delayed until your K3S is nearly assembled to avoid the chance of shorting the cell and damaging traces on the board by setting the partially-built rig on a tool or other conductor.

⚠ CAUTION

Once the battery is installed, take care not to set the K3S on a metal tool or other conductive surface that could short the battery and damage circuit traces. If you wish, you can delay installation of the battery until the K3S is complete.

Insert the CR2032 cell into battery holder BT1 as shown in Figure 62. Be sure the positive side of the battery (marked with a +) is facing up.

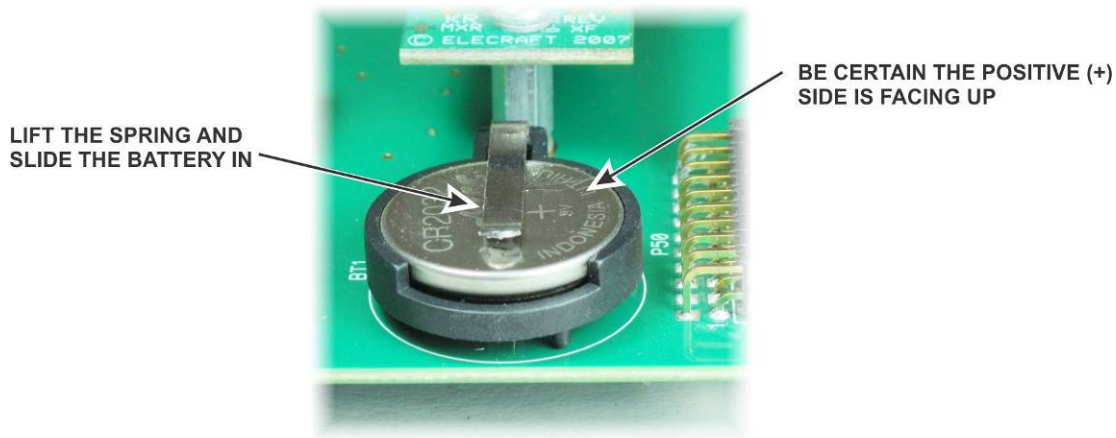

Figure 62. Installing BT1.

Mount Left Side Panel

If you installed the REF connector for the K3EXREF option (see Figure 47 on page 38), route the coaxial cable across the RF board and up between the front panel shield and the circuit boards as shown in your K3EXREF Installation manual.

Locate the left side panel. Both side panels are approximately 4" (10 cm) by 9-7/8" (25 cm) in size but with different hole patterns. The left side panel is shown in Figure 63

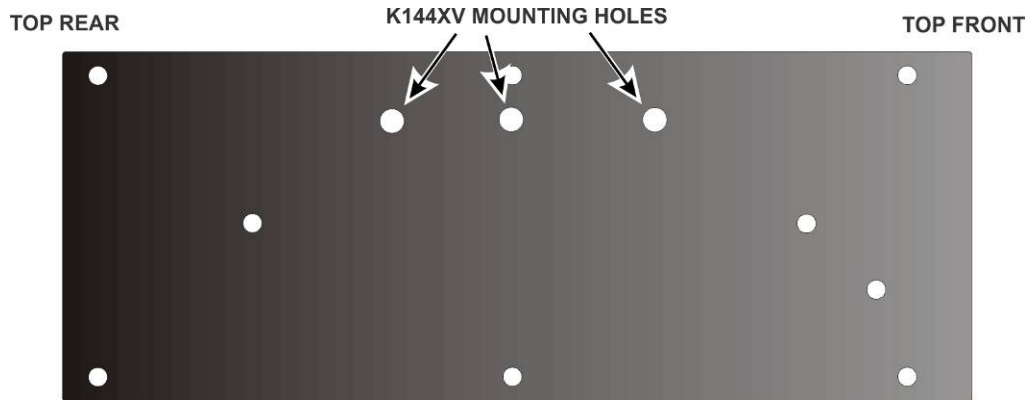

Figure 63. Left Side Panel.

Check the inside (partially painted) of the panel to ensure no masking tape is covering any screw holes. If found, peel it off.

Attach the handle to the left side cover using the hardware shown in Figure 64 at each end. The ribbed side of the handle faces away from the panel. Tighten the screws enough to compress the lock washers, but do not tighten the screws so much that you deform the handle end cover. The handle should move easily to allow room for your fingers between the handle and cover for carrying, then lie flat against the cover when it is not in use.

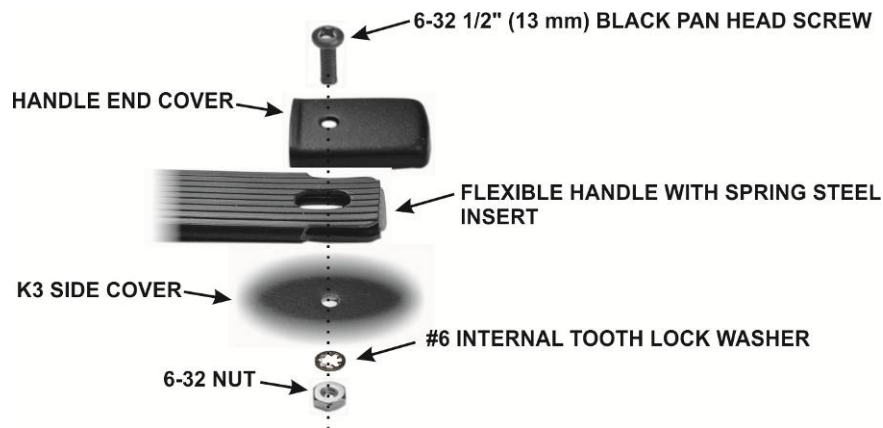

Figure 64. Installing Side Handle Mounting Hardware.

Mount a 2D fastener at the top rear corner of the panel with a 4-40 3/16" (4.8 mm) black flat head screw (SS) as shown in Figure 65. Do **not** use washers. Be sure the 2D fastener is oriented correctly as shown in the figure.

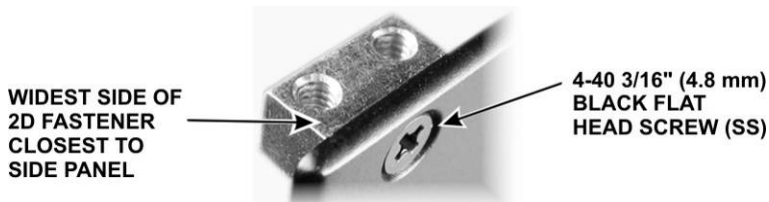

Figure 65. Installing Left Side Panel 2D Fastener.

If you do not have the optional K144XV two-meter module, install three 6-32, 1/4" (6.4 mm) screws in the larger holes in the side panel shown in Figure 66. Use a #6 nut and split ring lock washer on the inside to secure each screw. These holes are for mounting the optional K144XV 2-meter module. The screws are provided to fill them when the option is not installed.

Attach the left side panel to the RF board assembly as shown in Figure 16 using 4-40 3/16" (4.8 mm) black flat head screws (SS). Do **not** use washers. When oriented correctly, the edge of the panel will extend about 1/2" (13 mm) past the 2D fasteners at the front panel shield. If needed, loosen the screws attaching the 2D fasteners to the RF board or front panel shield for best alignment. Tighten them again after the side panel is installed.

⚠ Be sure the coaxial cable(s) shown in Figure 55 passes through the notch in the RF board and are not trapped between the edge of the board and the side panel.



Figure 66. Mounting Left Side Panel.

Check to be sure you installed a 4-40 3/16" (4.8 mm) screw in the hole just below the forward end of the handle. Failure to establish a solid contact between the side panel and the front panel shield may result in birdies in the receiver.

- Turn the K3S over and plug the KXV3B cable into P86 on the RF board as shown in Figure 67.

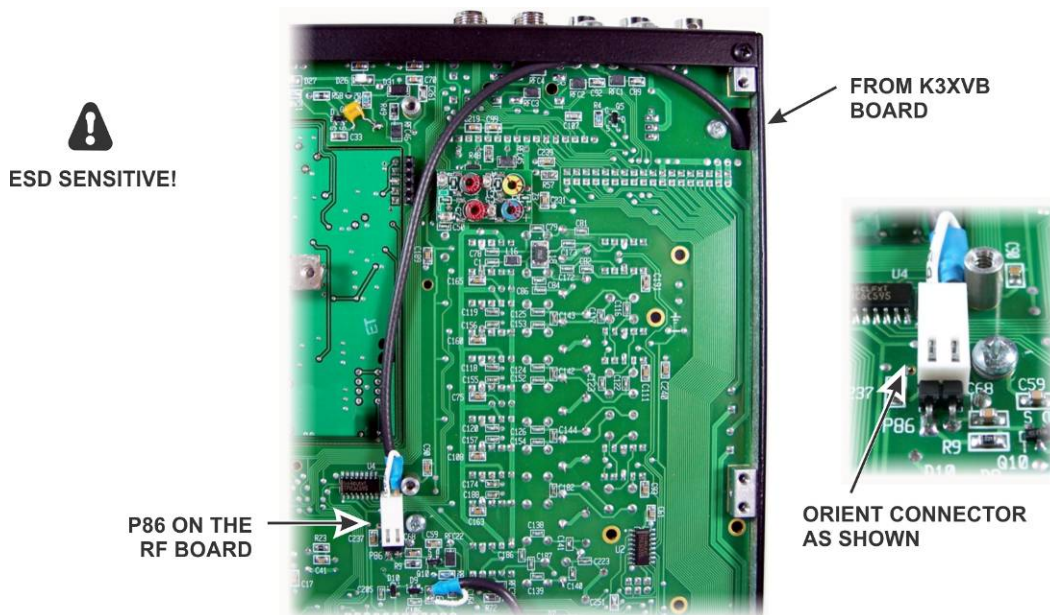

Figure 67. Routing the KXV3B Cable to P86.

Installing the KANT3 input module or KAT3A antenna tuner

The basic K3S/10 includes a KANT3 antenna input module. If you've ordered a KAT3 antenna tuner, the KANT3 is not required and will not be supplied with the kit. In either case, the module plugs into the RF board at the back-right corner. Both the KANT3 and KAT3A provide antenna surge protection, as well as resistors for bleeding off static DC charge. The KAT3A provides a wide-range, switchable C-in/C-out L-network. See *Theory of Operation, KANT3 and KAT3A*, in the K3S Owner's Manual for more details.

□ Insert J70 on the KANT3 or the KAT3A board into P70 near the red and black APP power connectors at the right rear corner of the RF board. The KANT3 board is shown in Figure 68. The KANT3 board fits exactly the same way *with the toroidal inductors toward the center of the RF board*. When installing a KAT3A antenna tuner, a relay on the KAT3A may strike resettable fuse F1 on the RF board. If so, gently bend the fuse to clear as shown in Figure 69. If the sub receiver AUX antenna connector is installed, route the coax between the board and the rear panel as shown.

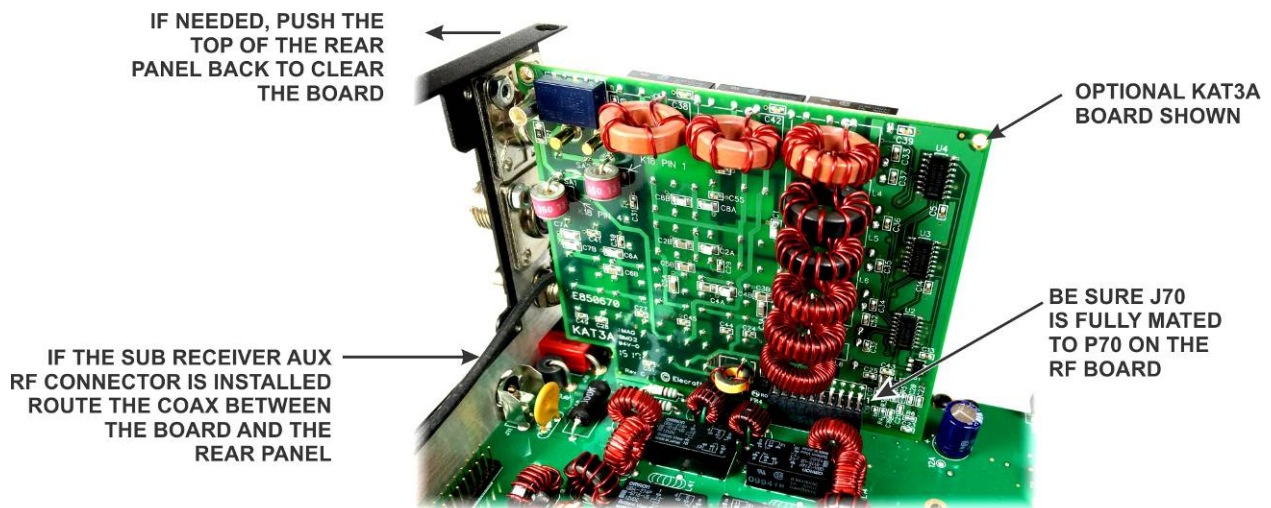

Figure 68. Installing the KANT3 or KAT3A Board.

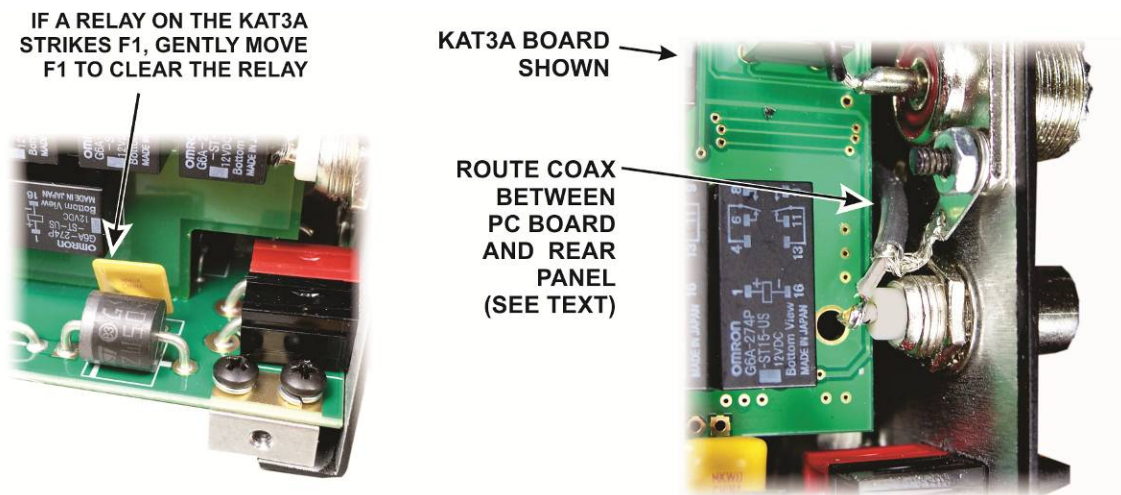

Figure 69. Adjusting F1 and Routing AUX Coax.

Connect the wires from the SO239 connector(s) to the KANT3 or KAT3A board as shown in Figure 70. Use needle-nose pliers to grip the terminals on the wire ends and carefully insert the connectors *straight* into the holes in the board. They may be very difficult to insert unless they are perfectly aligned. While inserting the plugs, support the board with your fingers to avoid putting stress on the connector at the bottom.

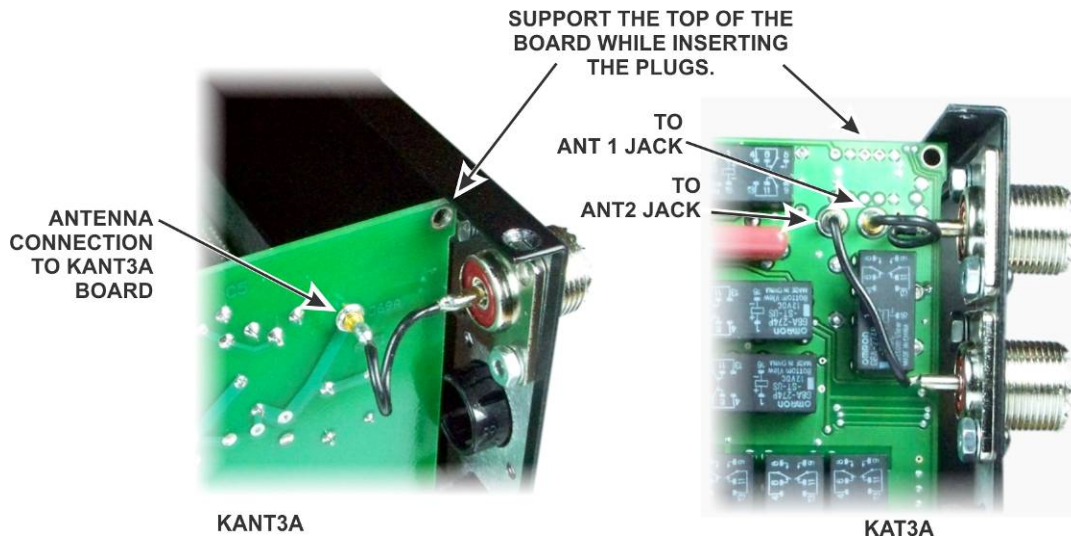

Figure 70. ANT Connections to KANT3 or KAT3A Boards.

Installing the Right Side Panel

Check the inside (partially painted) of the panel to ensure no masking tape is covering any screw holes. If found, peel it off.

Install the four rubber side feet in the holes in the right side panel as shown in Figure 71. Two suggested procedures for doing this are as follows:

Press Method:

- Wet the tip of the foot with a *tiny* amount of soap. (Do not use petroleum jelly or oils. They can deteriorate the rubber over time).
- Place the foot, tip up, on a solid work surface.
- Position the panel with the outside (fully painted side) toward the foot with the hole in the panel against the tip and press down. The tip should slip through the hole without further help. If necessary, grip the tip and pull with your long-nose pliers, working it from side to side until the shoulder opens against the inside of the panel. ***Do not use excessive force. You can tear the foot apart.***
- Wipe any excess soap off of the panel or foot.

Twist Method:

- Press the foot against the outside (fully painted side) of the panel so the tip is in the hole at an angle.
- While pressing the tip into the hole, twist the foot so the edge of the tip grabs the inside edge of the hole.
- Continue pressing and twisting until the tip is fully inside the panel all the way around its circumference. ***Do not twist with excessive force. You can tear the foot apart.***

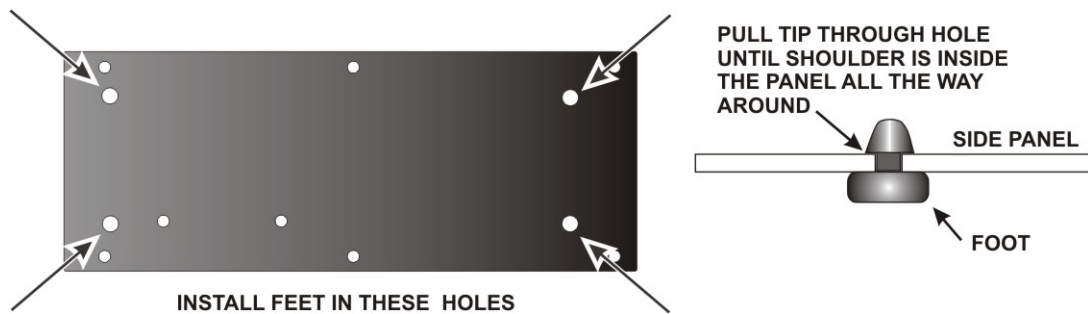

Figure 71. Installing Side Panel Feet.

Position the right side panel against the K3S to verify how it will fit against the RF board. When it is oriented correctly, the three holes along the bottom edge will line up with the holes in the 2D fasteners on the RF board and two holes in the side panel will be aligned with the tabs on voltage regulators U12 and U13. The end of the panel toward the rear will very nearly line up flush with the edge of the RF board. Do not mount the side panel yet, but note which corner of the panel is in the upper rear corner. You'll work with this corner in the next step.

At the upper rear corner of the side panel you just identified in the previous step, mount a 2D fastener as shown in Figure 72, using a black 4-40 1/2" (13 mm) flat head screw (SS). Remember that flat head screws are measured from the flat top to the end of the threads. Note that the screw extends some distance through the 2D fastener.

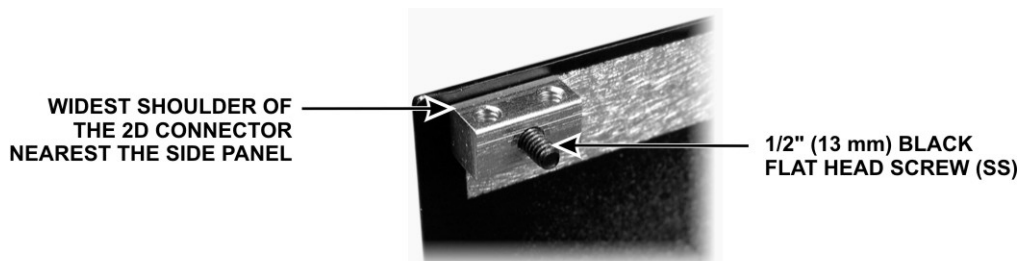

Figure 72. Mounting 2D fastener for KANT3 or KAT3A Standoff.

Screw a 4-40 1/2" (13 mm) standoff onto the exposed end of the screw as shown in Figure 73. **Do not use a lock washer between the standoff and the 2D fastener.** Tighten the standoff securely against the 2D fastener.

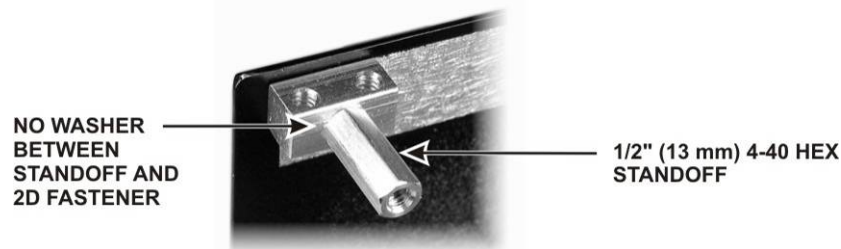

Figure 73. KAT3A/KANT3 Mounting Standoff.

Attach the right side panel to the RF board assembly four 4-40 3/16" (4.8mm) black flat head screws: three along the bottom and one at the top front into the 2D fastener on the front panel shield. Do **not** use washers.

Mount the KANT3 or KAT3A board to the standoff on the side panel with a 4-40 1/4" (6.4mm) zinc pan head screw and a #4 split lock washer under the screw head as shown in Figure 74. **Do not place a washer between the board and the standoff.**

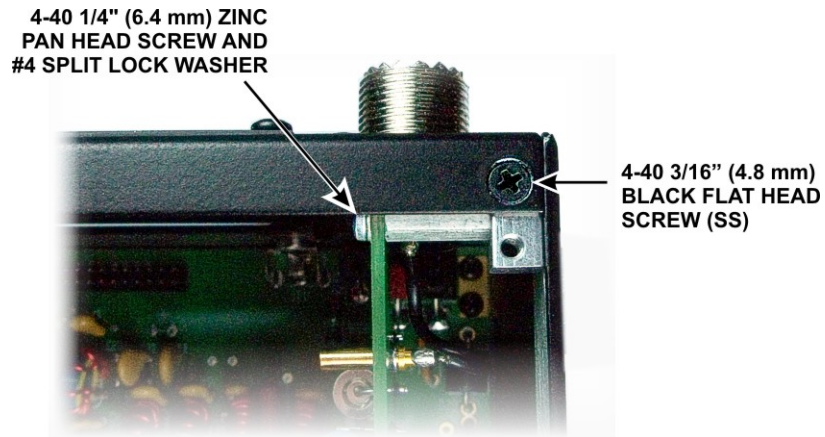

Figure 74. Installing KANT3/KAT3A Mounting Screw.

Install a 4-40 3/16" (4.8 mm) black flat head screw (SS) to secure the top of the rear panel to the 2D fastener as shown in Figure 74.

. When properly positioned, the rear panel should fit snugly against the inside edge of the side panels as shown in Figure 74. Verify the fit is correct against the side panels at both ends of the rear panel. If necessary loosen the 2D fastener screws enough to adjust the position of the panels. .

Attach voltage regulators U13 and U12 to the right side panel as shown in Figure 75 using a 4-40 3/8" (9.5 mm) black flat head screw (SS), #4 inside tooth lock washer and a #4 nut for each regulator as shown. When the screws are tightened the tabs on U12 and U13 should lie flat against the side panel.

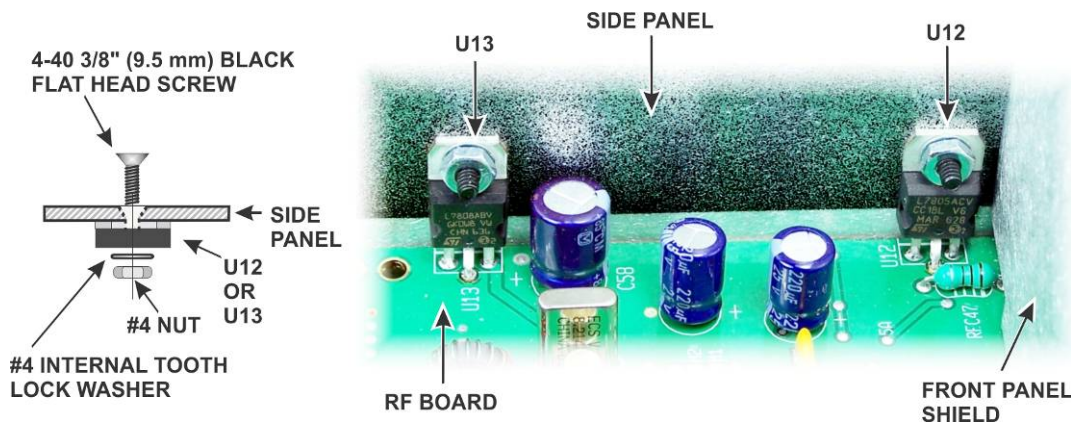

Figure 75. Attaching U12 and U13 to the Right Side Panel.

Resistance Checks

The following resistance checks confirm that the main power busses aren't shorted to ground. If any of the values measured are lower than specified, inspect the unit carefully for loose hardware that is caught between components on the boards or for improperly mated connectors.

Use your digital multimeter (DMM) to measure the resistance across the red and black 12VDC IN connectors on the rear panel. The resistance should be greater than 3K ohms. It may be much higher, depending upon which way you connect the leads. Your DMM may indicate the value is so high it is out of the range of the instrument and as it does when in ohms mode and the probes are not touching anything. If you are not sure, refer to your DMM instruction manual to interpret the reading.

Locate voltage regulators U12 and U13. They are mounted on the RF board and have tabs screwed to the right side panel (see Figure 68 on page 50).

Use your DMM to measure the resistance between the pins of U12 and U13 and ground as shown below.

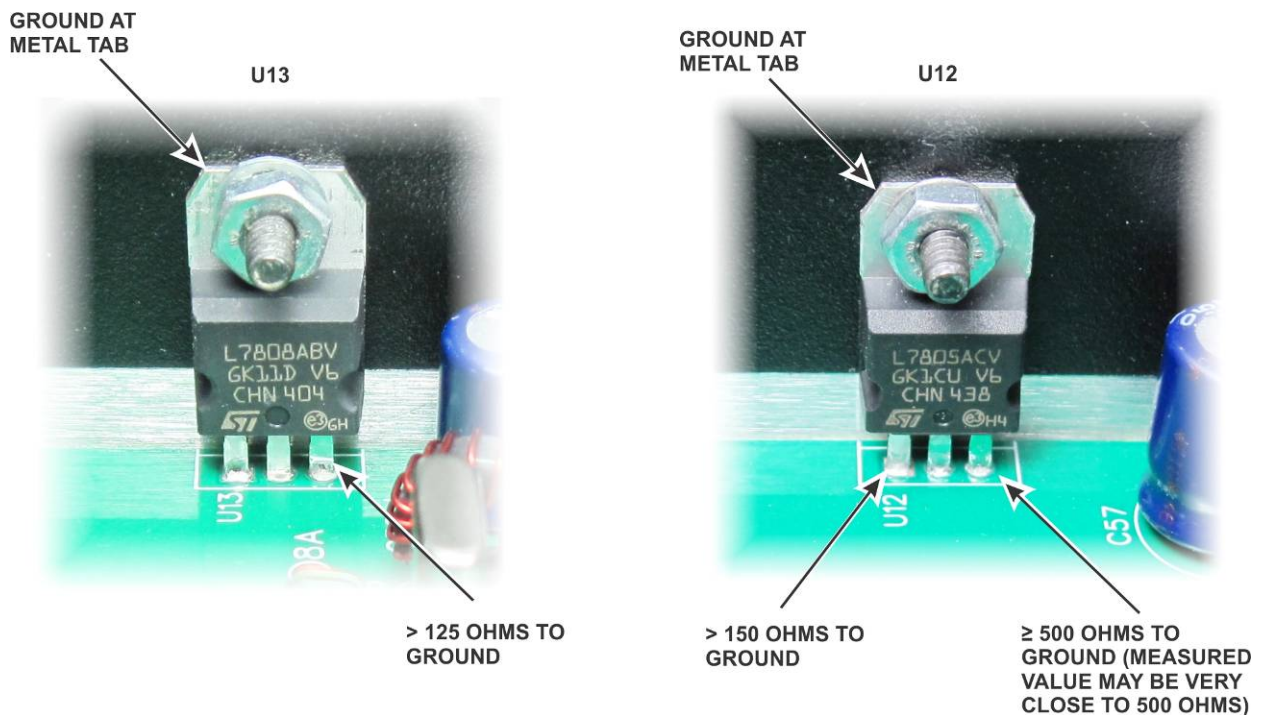

Figure 76. Checking U13 and U12 for Short Circuits.

Initial Power On Check

The following check confirms that the power supply and power control circuits are working properly. Be sure your K3S passes the resistance tests above before proceeding.

⚠ CAUTION!

If you see or smell smoke when applying power, turn the K3S off and remove the power cable immediately, then locate the source.

- Connect your 13.8 VDC power supply to the 12VDC IN connector on the rear panel. If you do not have a suitable cable handy, assemble the Power Supply Cable Kit supplied with your K3S. Do not connect a key, microphone or other accessories at this time.
- Tap (press for less than 1/2 second) the front panel **POWER** button and confirm the LCD display lights. There may be a delay of about 1 second before the display lights. Some front panel LEDs may light as well, and you may notice D33 on the RF board, next to the crystal filters, light. Ignore any error messages on the display and do not try to operate the radio at this time. You'll get to do that soon.
- Tap the front panel **POWER** button again to turn the K3S off and disconnect your external power supply.

KREF3 Reference Oscillator

The KREF3 module's 49.380-MHz temperature-compensated crystal oscillator (TCXO) is the common reference for the synthesizers. See *Theory of Operation, KREF3*, in the K3S Owner's Manual for more information.

- Locate the Temperature-Compensated Crystal Oscillator (TCXO) module. If you ordered the optional ± 1 ppm TCXO it will be supplied *instead* of the standard 5 ppm module (see Figure 77).
 - Note the position of a small colored dot on the top of the module. It is sometimes faint and may be hard to see without good light. The dot allows you to orient the module correctly in the socket. Some modules have four pins while others have only three. If your module has three pins, the missing pin is in the same corner as the painted dot.

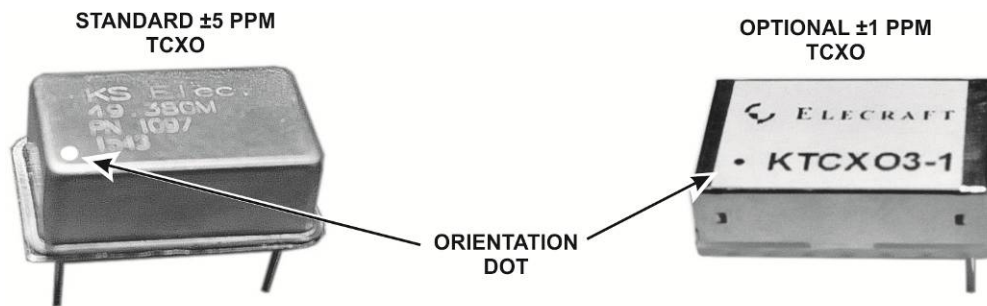

NOTE: SOME OSCILLATORS HAVE ONLY TWO PINS.

Figure 77. TCXO Modules.

- If you have the optional ± 1 ppm module, it is supplied with a thin flat insulator that fits over the pins to cover the bottom. Place the insulator over the pins. *This insulator is not used on the standard ± 5 ppm module.*

□ Mount the TCXO module on the KREF3 board as shown in Figure 78. Be certain the leads go into the corner holes in the socket and the black dot is oriented toward connector J6 as shown. If you have a 1ppm high-stability module, the dot may be light brown and not as close to the corner. If the module has only three leads, the missing lead will be in the corner with the dot. If you have the standard 5ppm TCXO, the bottom may be slightly above the socket when the leads are fully inserted. Tighten the tie wrap enough to ensure the oscillator so it cannot fall out but do not bend the leads.

⚠ **Note the label on your TCXO may be slightly different from that shown.**

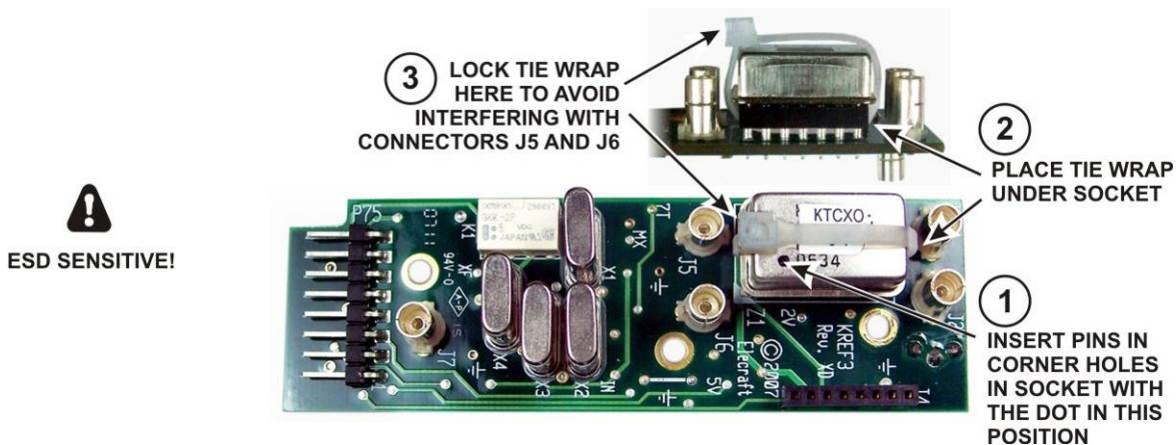

Figure 78. Mounting TCXO Module on KREF3 Board.

□ Inspect the bottom of the KREF3 to ensure no leads are higher than the chokes as shown below. The chokes are the highest of the black surface-mount components on the board. Use your diagonal cutters to trim any excessively long leads close to the board.

⚠ CAUTION

The objective is to be certain no bare leads touch the front panel shield when the board is installed in the next step. Do not add spacers or insulating material between the board and the front panel shield. It is important for proper shielding of the circuits that the board sit very close to the front panel shield.



Figure 79. Checking Lead Lengths on KREF3 Board.

□ If you are installing the K3EXREF option, mount the K3EXREF board on the KREF3 board as shown in the *K3 K3EXREF Frequency Lock Option* manual, Figures 8 and 9 (pages 9 and 10). Be sure to install the shorting block as shown in Figure 8.

⚠ CAUTION

In the following step it is easy to drop screws and lock washers into the K3s. If this happens, you must find and retrieve the hardware. Failing to do so may cause short circuits and damage your K3s when power is applied.

Recommend you practice installing the KREF3 board without the screw and washers first to acquaint yourself with the procedure for inserting it and fitting the connector through the hole in the front panel shield. You'll need to do this smoothly to avoid dropping the hardware.

☐ Install the KREF3 board on the back side of the front panel shield as shown in Figure 80. The board plugs into the J75 KREF3 connector just behind the shield. **Be certain you use a split lock washer between the KREF3 board and the PEM nut attached to the shield. An internal tooth washer may short out nearby circuit traces.**

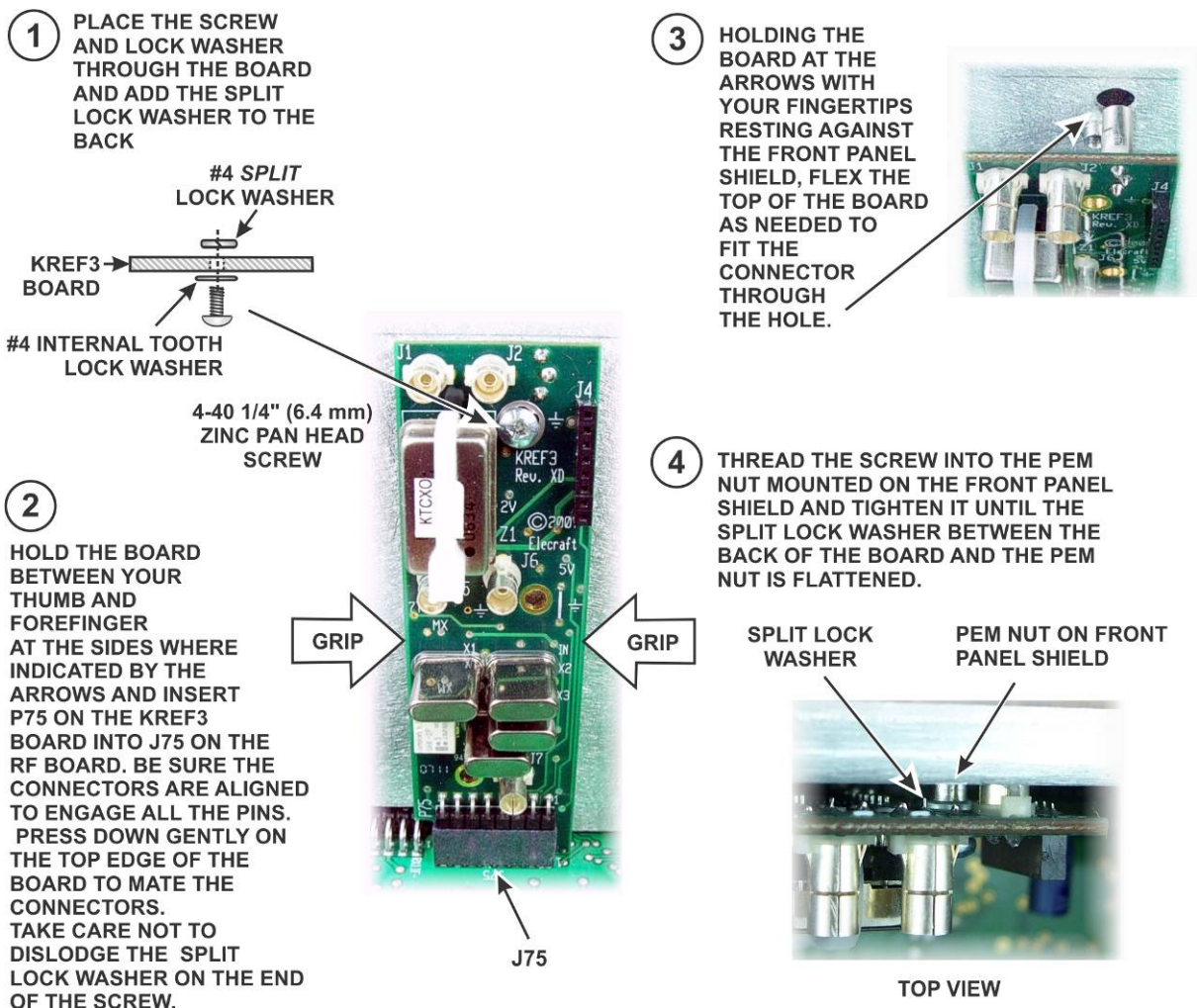

Figure 80. Installing KREF3 Board.

☐ If you are installing the K3EXREF option, connect the TMP connector on the cable leading to the rear panel REF connector to the connector on the KREF3 board that passes through the front panel shield.

Installing the KSYN3A Synthesizer

The KSYN3A module is a high-performance, wide-range synthesizer covering 8 to 46 MHz. It is based on a high-performance phased-lock loop IC that uses direct-digital synthesis for fine tuning. This IC has exceptionally low timing jitter, resulting in very low phase noise. The output signal is locked to the K3's 49.380-MHz reference to within a fraction of a Hz. See *Theory of Operation, KSYN3*, in the *K3 Owner's Manual* for more information.

☐ Inspect the bottom of the KSYN3A board to ensure no leads are higher than the chokes as shown in Figure 81. The chokes are the highest of the black surface-mount components on the board. Use your diagonal cutters to trim any excessively long leads close to the board.

⚠ CAUTION

The objective is to be certain no bare leads touch the front panel shield when the board is installed in the next step. Do not add spacers or insulating material between the board and the front panel shield. It is important for proper shielding of the circuits that the board sit very close to the front panel shield.

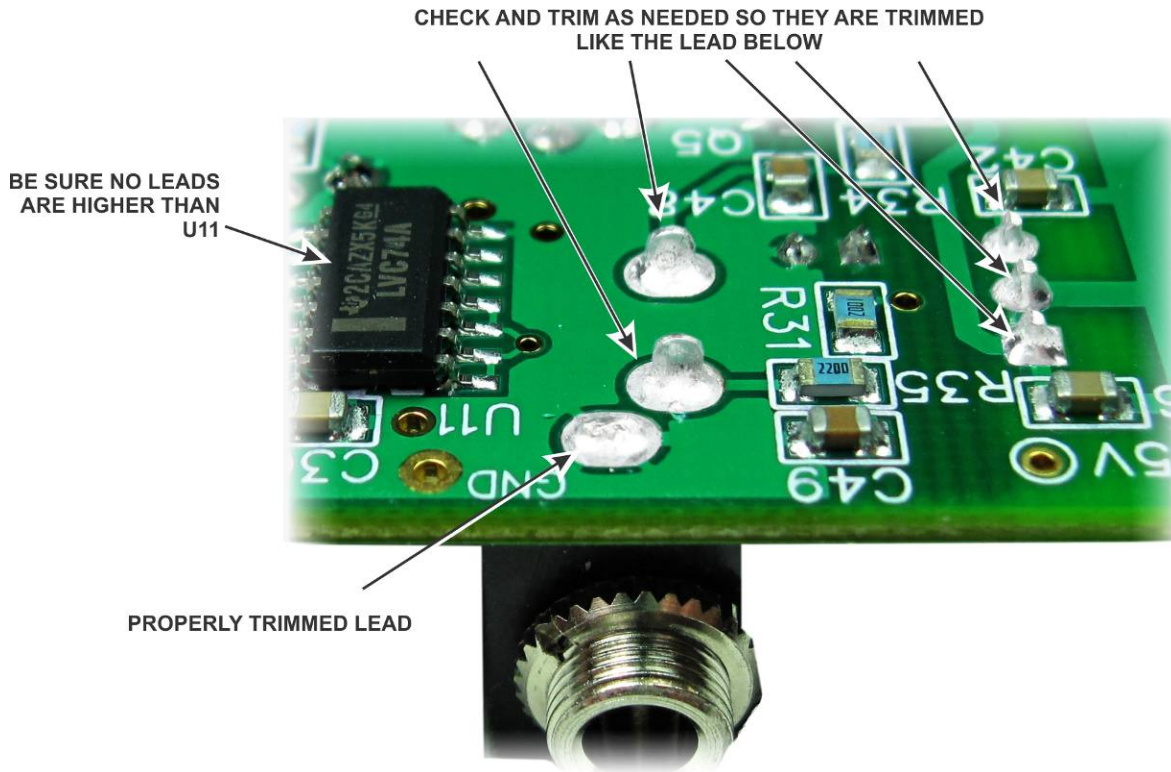

Figure 81. Trimming the Synthesizer Leads.

☐ Install the KSYN3 board on the back side of the front panel shield as shown in Figure 82. The screws and lock washers are supplied in a separate envelope marked KSYN3A.

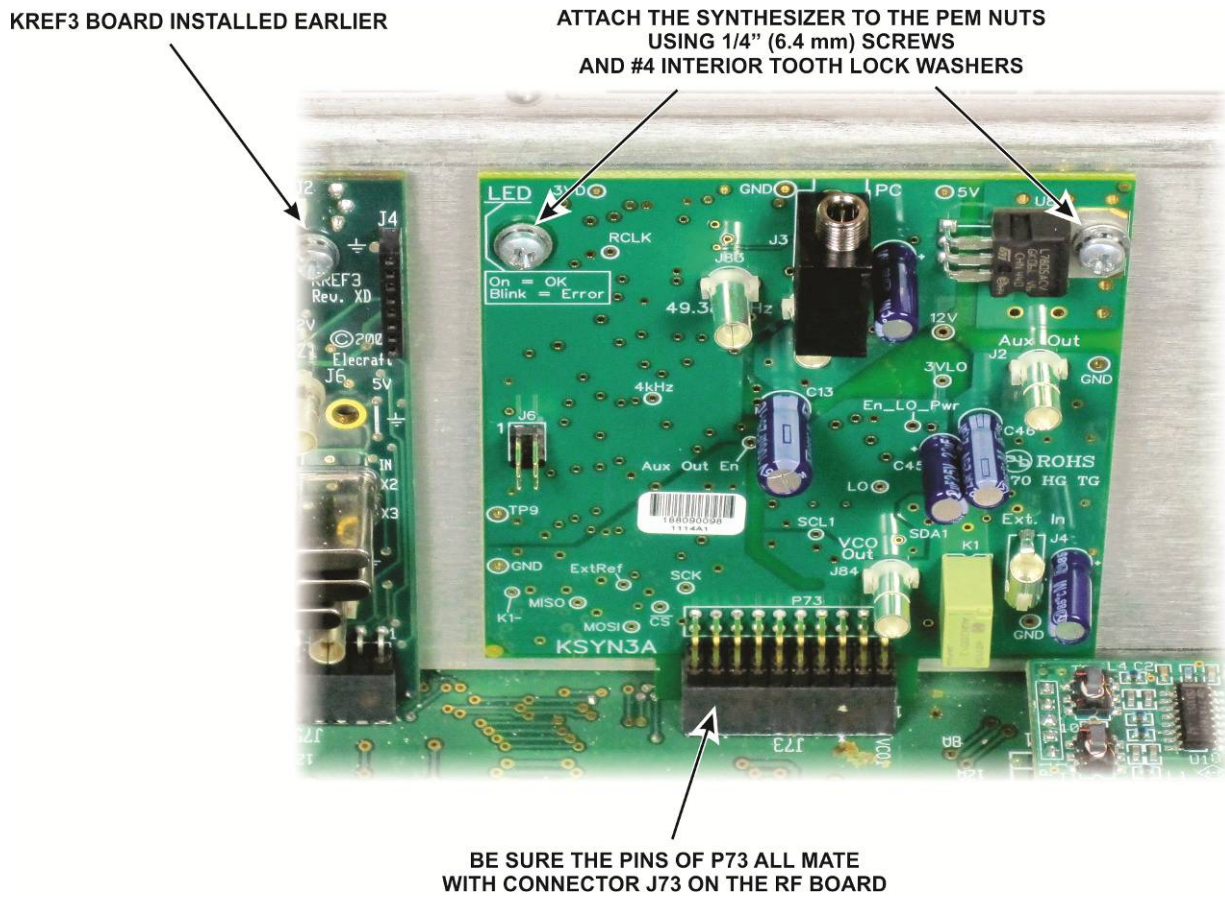

Figure 82. Installing the KSYN3 Board.

☐ Locate the three TMP cables. They are about 1/8" (3 mm) diameter coaxial cables with connectors at each end as shown in Figure 83. Check each cable and trim any excess center conductor strands extending beyond the end of the pin as shown. This will make mating the connectors much easier.

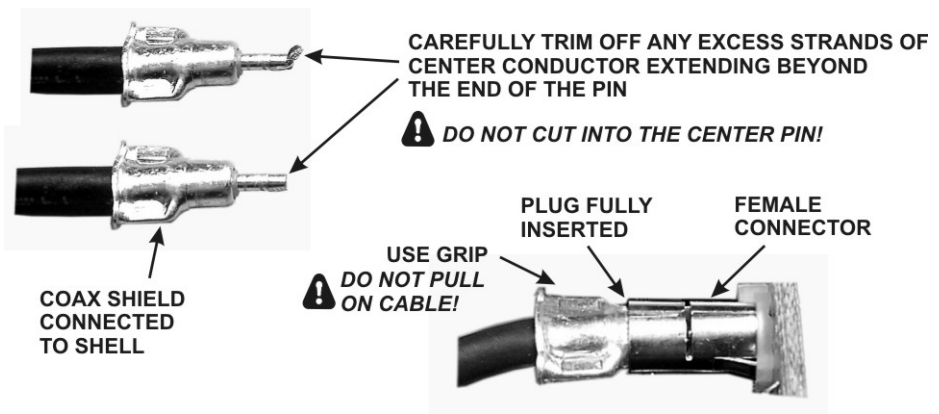

Figure 83. TMP Cable Connectors.

□ Install the three TMP cables between connectors on the KREF3 board, the main RF board and the KSYN3 board as follows. Handle the connectors by the finger-grip area shown in Figure 83, especially if you unplug a connector. **Do not pull on the coaxial cable to unplug a connector!** When mating the connectors, be sure the plugs are fully inserted as shown in Figure 83. To make the connectors easier to mate, first be sure the center pin is started in the socket, then you may twist the connector back and forth while holding it by the metal ears if needed to seat it fully as shown in Figure 83.

- KREF3 board J7 to RF board J65.
- KREF3 board J6 to RF board J81.
- KREF3 board J2 to KSYN3 board J83.

The cabling is also shown in pictorial view in Figure 85.

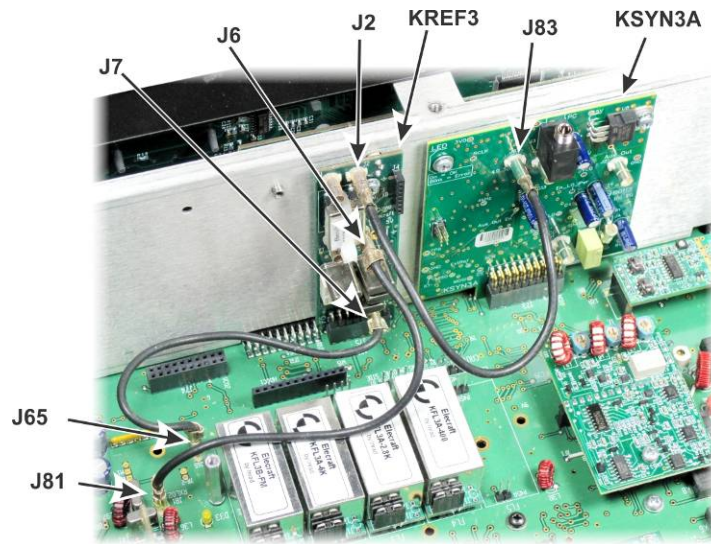

Figure 84. Installing KREF3 TMP Cables.

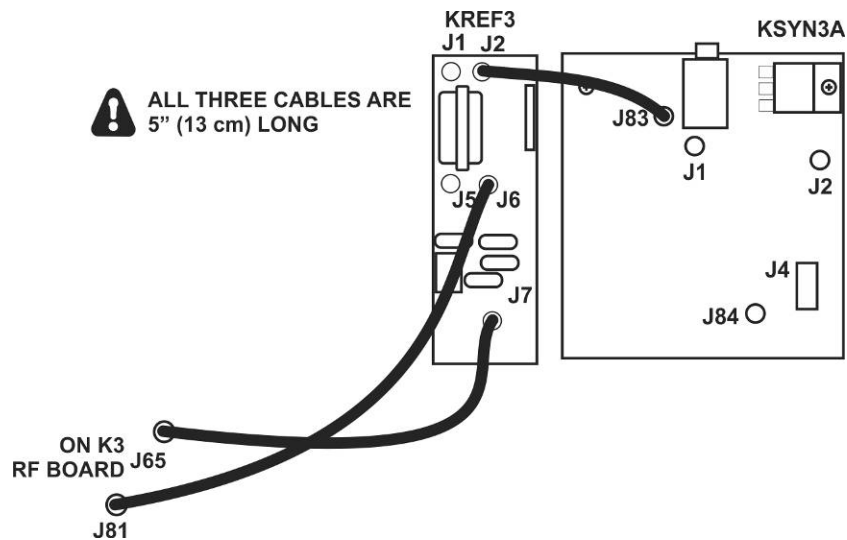

Figure 85. KREF3 TMP Cable Connections, Pictorial View.

Loudspeaker, Top Cover and KPA3A Shield

The built-in loudspeaker is mounted on the top cover. A grill cloth covering the sound holes keeps dust and debris from falling into the speaker cone. The loudspeaker is equipped with a magnetic shield to avoid unwanted interaction with nearby circuits. A chassis stiffener bar runs across the top of the chassis and, if the KPA3A 100 watt amplifier option is installed, attaches to the shield around the amplifier module.

- Locate the top cover and check the inside for any masking tape still covering screw holes. If found, peel it off.
- Mount the chassis stiffening bracket on the underside of the cover as shown in Figure 86. Do not use washers.

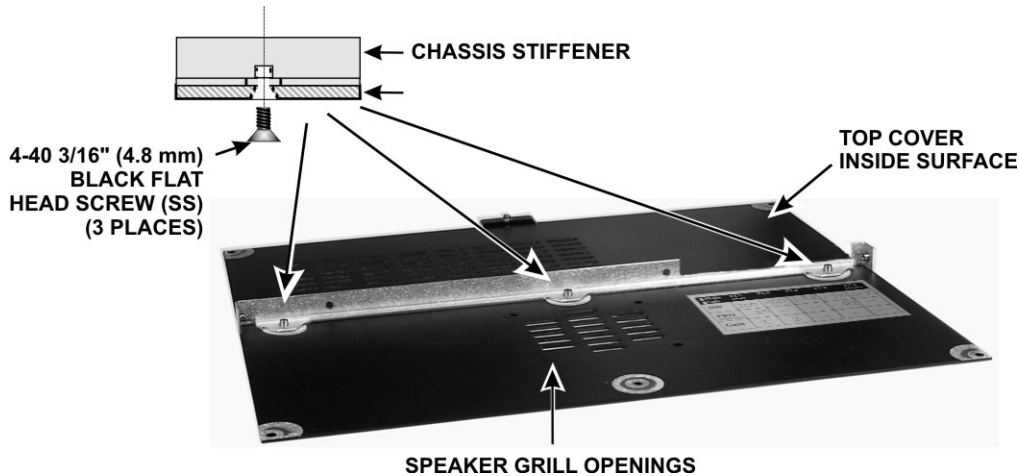

Figure 86. Attaching Chassis Stiffener to Top Cover.

- Trim the grill cloth to cover the speaker grill openings and overlap the four holes for the loudspeaker mounting screws. Mark and cut four holes in the grill cloth for screws to pass through the cloth. The grill cloth is shown as it must fit after the speaker is mounted in Figure 87. Normally, the stiffener will remain attached to the K3 when you remove the top cover. If you install the KPA3A 100-watt amplifier, the stiffener will be attached to the KPA3A shield and cannot be removed with the cover (see Figure 92 on page 64). The grill cloth must be trimmed as shown so it cannot become trapped between the chassis stiffener and the top cover when the cover is removed and replaced.

⚠ CAUTION!

Failing to install the fiber washers as shown in the next step or over-tightening the screws so that the speaker mounting flanges are distorted may damage the speaker, causing distorted, fuzzy sound.

- Mount the speaker using the hardware shown in Figure 87. A suggested procedure for doing this is as follows:
 - Find a book or other flat-smooth surface that is about the size of the top cover.
 - From the top, place the screws in the four holes at the corners of the speaker grill area.
 - Cover the screw heads with the book and, holding it in place against the top cover, invert the cover and lay it with the book on your work table so the bottom side is facing upwards.
 - Trim and cut screw holes in the grill cloth as needed and position it over the four screws that are now held in place by the book. Trim the grill cloth so the cloth does not touch the stiffener.

- Place a fiber washer on each screw so it rests on the grill cloth.
- Position the loudspeaker on the four screws so they pass through the holes in the flanges. Orient the speaker so the wire exits toward the rear (the side nearest the stiffener).
- Place a #4 internal tooth lock washer on each screw.
- Start a 4-40 nut on each screw.
- Pick up the entire assembly and tighten all four screws. **Do not tighten the screws enough to bend the speaker flanges!**

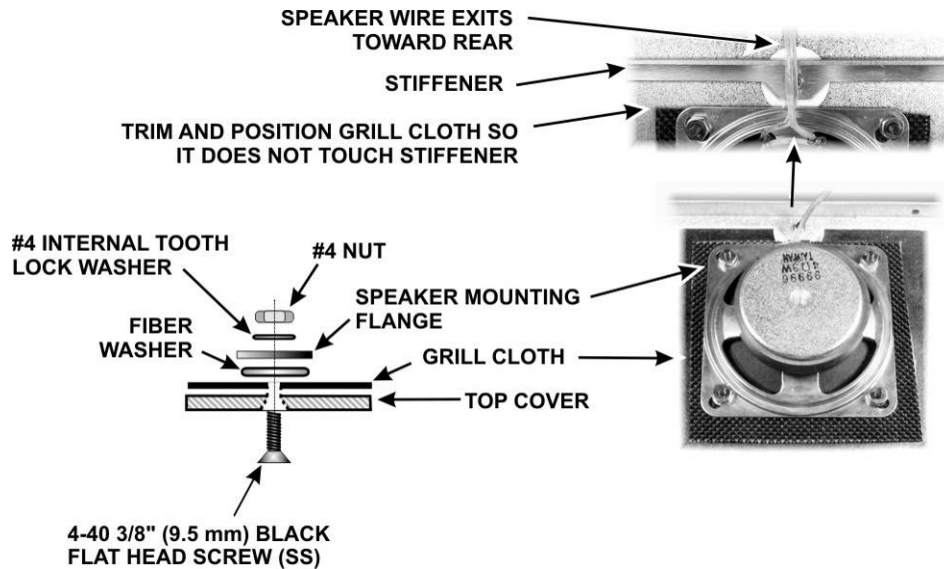

Figure 87. Mounting Loudspeaker.

- Install the shield over the speaker magnet as shown in Figure 88.

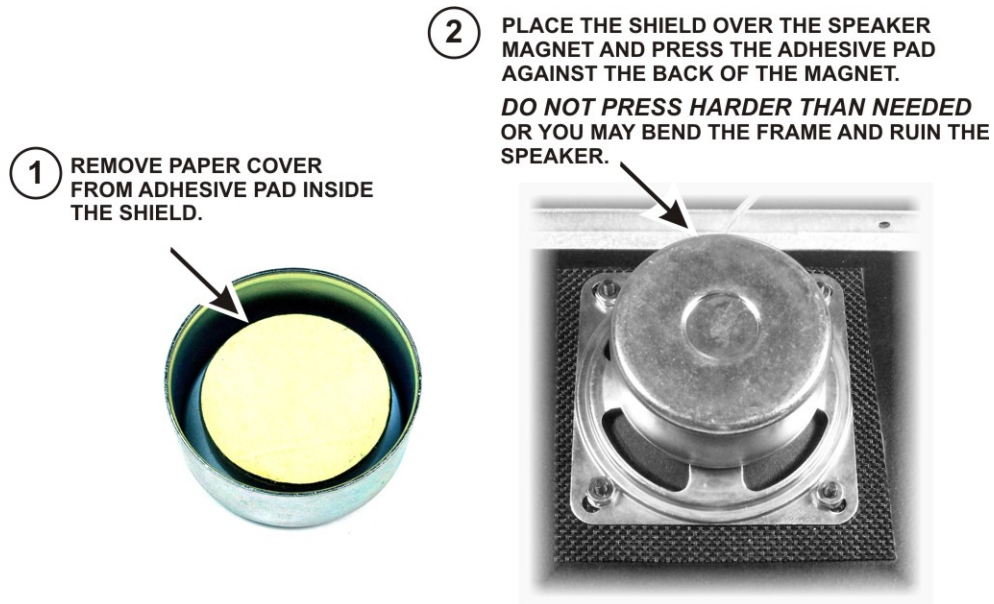

Figure 88. Installing Speaker Magnet Shield.

KPA3A Shield

If you are *not* planning to install the KPA3A module at this time, skip this section and go directly to *Installing the KNB3 Noise Blanker* on page 63. Only the KPA3A shield is installed at this time to avoid rework later. You will be directed to finish installing the KPA3A module after initial testing and calibration of your K3S.

The KPA3A shield is part of the optional KPA3A 100-watt amplifier module. It isolates the high-level RF circuits in the KPA3A from the rest of the K3S and provides mechanical support for the amplifier module itself.

□ Attach the shield to the RF board and to the rear panel as shown in Figure 89. The screws, washers and nut are in the KPA3A Option kit. The standoffs are part of the K3S kit hardware.

⚠ Take care to avoid putting pressure on the large capacitor shown in the figure. If needed, remove the screw at the top of the rear panel nearest the KIO3B interface and then flex the top of the rear panel a small amount to provide clearance for the shield. Be sure to replace the screw after the shield is in position.

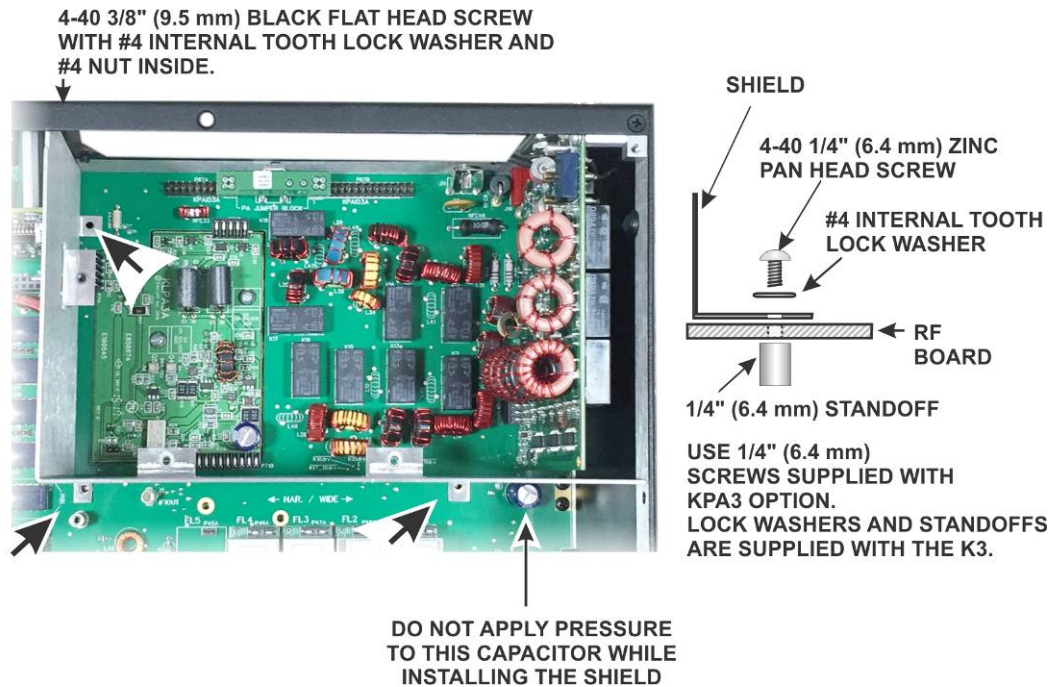

Figure 89. Attaching the KPA3A Shield.

Installing the KNB3 Noise Blanker

The KNB3 is one of two noise blanker systems in the K3S. It is a narrow I.F. pulse blanker that plugs into the RF board. See *Theory of Operation, Noise Blanker* in the K3S Owner's Manual for more information. The noise blanker installation has been delayed because it must be removed to install the KPA3A shield.

- Install the standoff for the noise blanker as shown in Figure 90. The location of J77 is to the left of crystal filter position FL5 on the RF board. Be sure to put *two* split lock washers between the standoff and the RF board as shown.

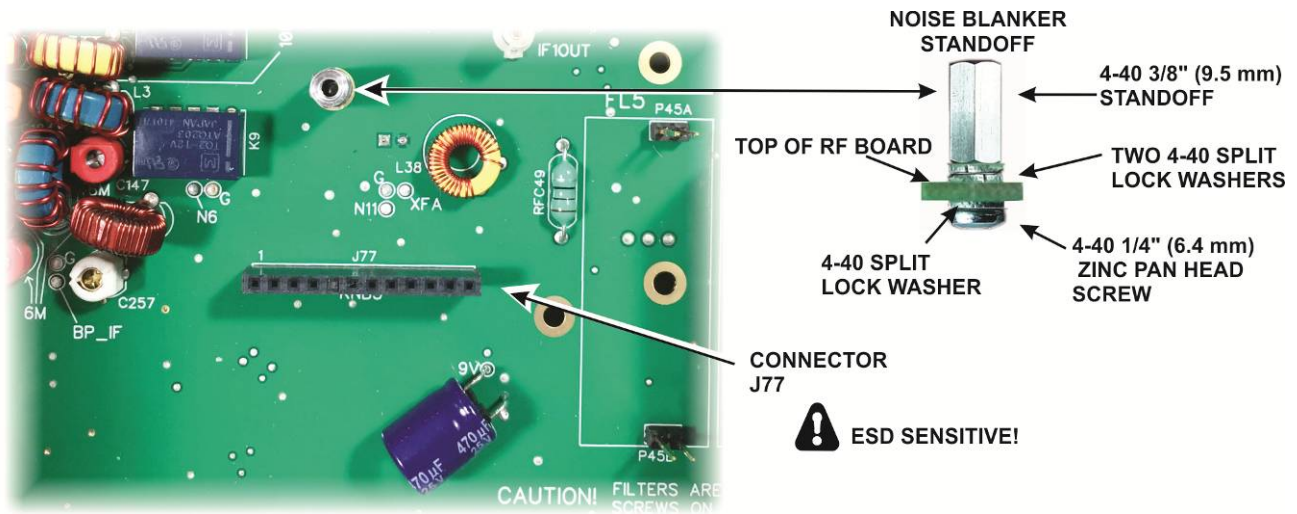

Figure 90. Installing Noise Blanker Standoff.

- Plug the noise blanker board into J77 and attach it to the standoff using the hardware shown in Figure 91.

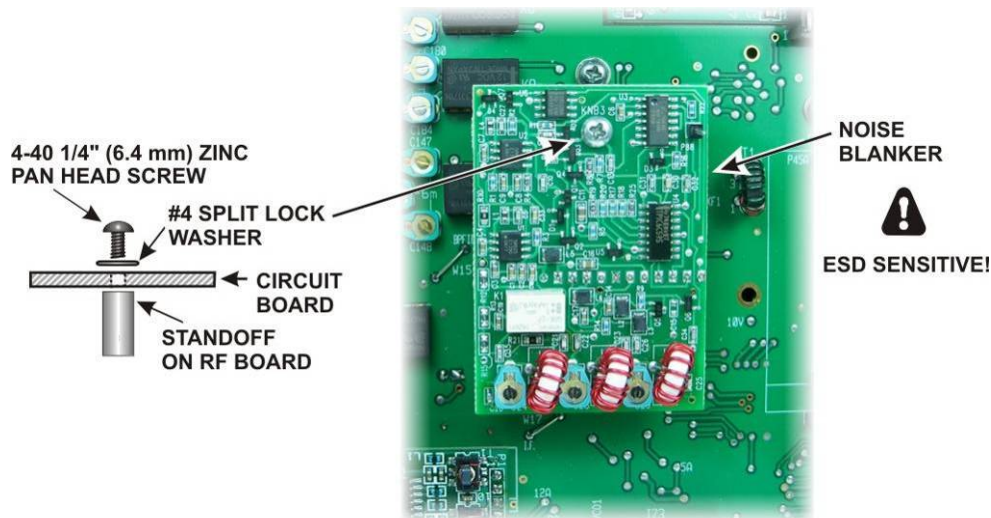

Figure 91. Installing the Noise Blanker Board.

Installing the Chassis Stiffener

Remove the stiffener bar from the top cover and install it on the chassis as shown in Figure 92. The hardware required to attach it to the shield are in the KPA3A Option kit. The black flat head screws used to attach it to the side panels are part of the K3S kit hardware.

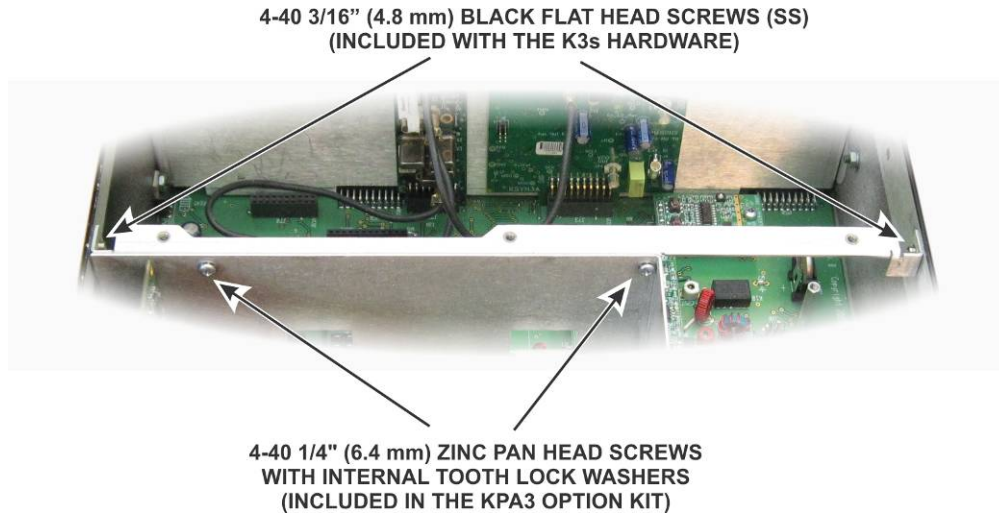

Figure 92. Installing the Chassis Stiffener Bar.

Bottom Cover

Bottom Cover Description

The bottom cover is divided into two parts, the rear and forward sections. The rear section is slightly thicker than the forward section to act more efficiently as a heat sink for the LPA transistors. The bottom covers attach to standoffs as well as the 2D fasteners on the bottom of the RF Board. A folding tilt stand and feet are mounted on the cover panels.

Bottom Cover Hardware Installation Procedure

Install the standoffs on the bottom of the RF board shown in Figure 93. If you installed the KPA3A shield, three of the four standoffs required are already in place. ***If so, be sure to install the remaining standoff!***

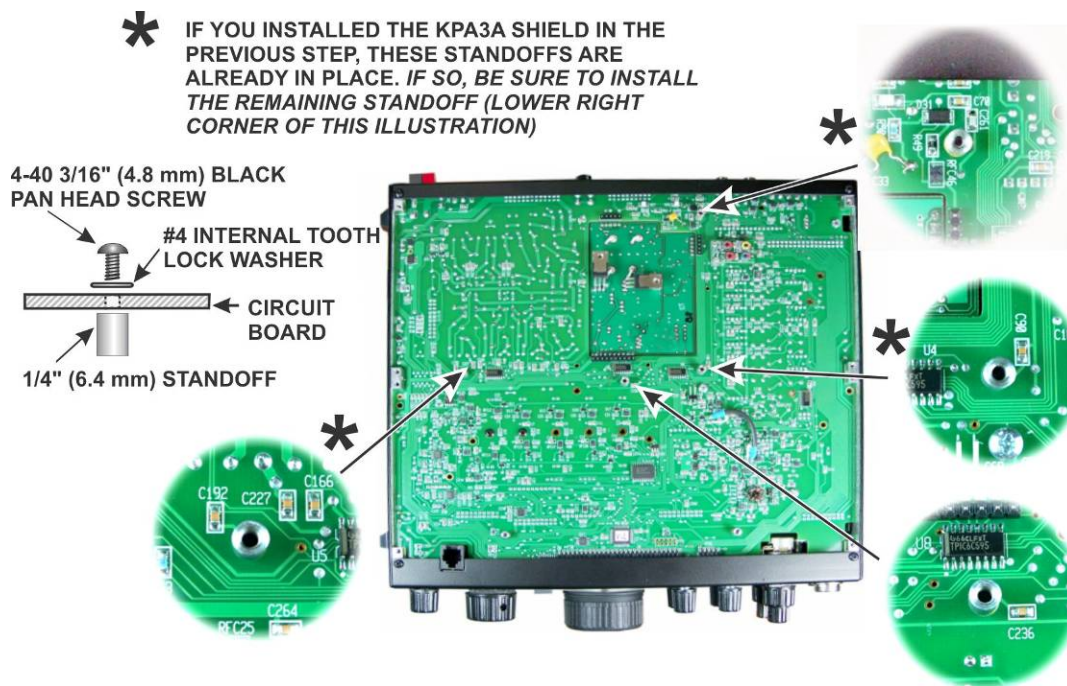

Figure 93. Installing Standoffs on RF Board.

- Identify the bottom cover forward section by test fitting it on the bottom of the K3. The forward section is the thinner panel with a notch along one edge (see Figure 94).
- One side of the cover is fully painted. That is the outside. The other side has areas of bare metal left to ensure good electrical contact with the other cabinet parts. Check the inside surface for any masking tape left from the painting process. If found, peel it off.
- Attach the front feet and tilt stand to bottom cover section A as follows. Insert a 4-40 7/16" (11 mm) zinc pan head screw (SS) through the cover *with the screw head on the inside*, and place a foot over the screw on the outside (fully painted) of the cover. Orient the foot as shown in Figure 94. Place a #4 lock washer (SS) and 4-40 nut (SS) on the end of the screw inside the hole in the foot, and put your finger over the hole to hold the nut against the screw. Turn the screw to start the nut onto the threads but do not tighten it. Repeat the procedure for the second screw in the foot. Leave the foot as loose as possible without the hardware falling off.
- Install the tilt stand and second foot as shown in Figure 94. You may need to press the foot against the tilt stand to get the 4-40 7/16" (11mm) screws (SS) to pass through the cover and foot. Put a #4 lock washer (SS) and nut (SS) on each screw as you did before.
- Tighten all four screws. It should not be necessary to put a tool on the nuts. Friction against the feet and the lock washers should hold them securely while you tighten them by turning the screw heads.

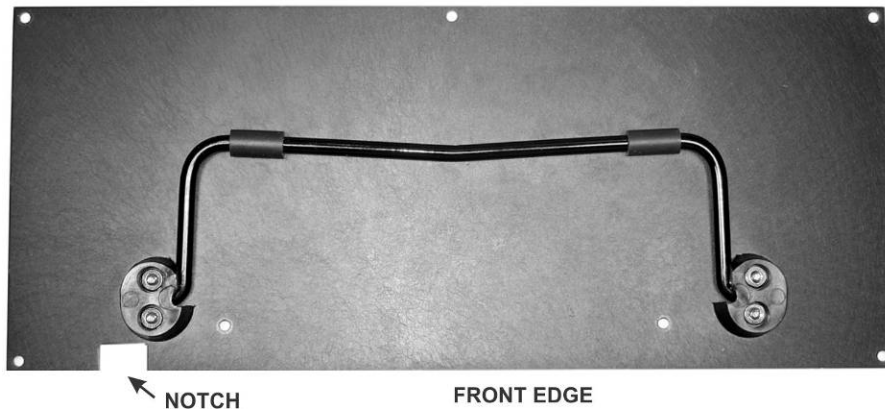
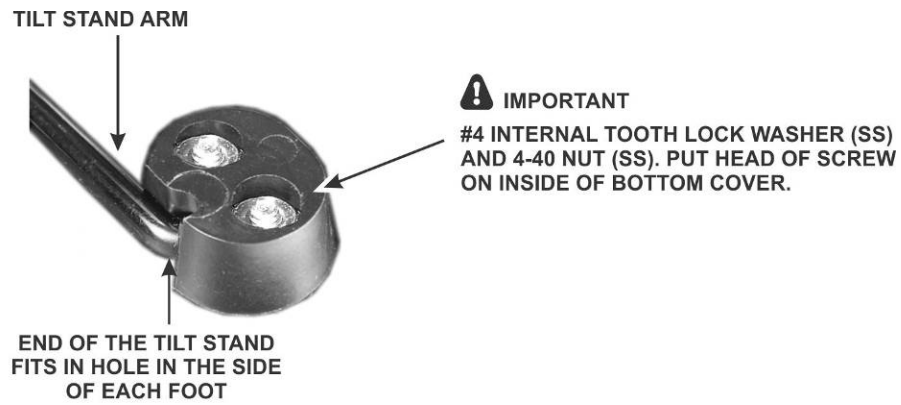

Figure 94. Installing Tilt Stand.

Locate the rear bottom cover section. This cover has eight rectangular slots cut in it. Like the front section, bare metal is exposed in some areas on the inside surface. The bare metal ensures good electrical contact with the other cabinet parts and good thermal contact with the heat sinks for Q4 and Q5 on the KLPA3A circuit board.

Check the inside surface of the bottom cover for any masking tape that may have been left from the painting process. If found, peel it off. Two of the screw holes inside bottom cover section B have *not* had the paint removed from them. These are the mounting holes for the two rear feet. Attach each foot as shown in Figure 95. Note that these screws are also installed with their heads on the inside surface.

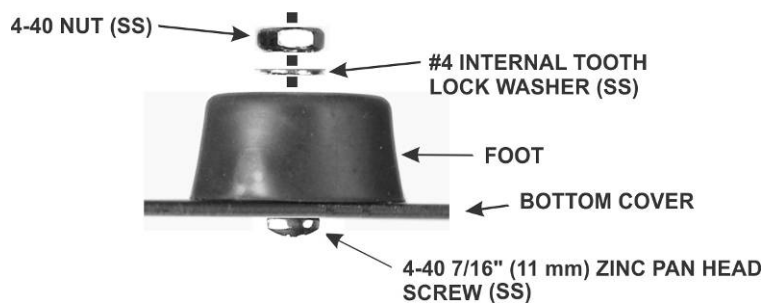

Figure 95. Installing Rear Feet.

Set both bottom covers aside in a safe place. They will be mounted on the K3S later.

KBPF3A General Coverage Receive Option

If you have the KBPF3A General Coverage Receive option kit, install the board as follows. Otherwise skip this section and go directly to *Power Amplifier Jumper Block* on page 67.

KBPF3A Description

The KBPF3A extends the receive coverage outside of the Ham bands over the range of 100 kHz to 30 MHz and from 48 MHz through 54 MHz. Only the receiver coverage is extended. The transmitter frequency coverage is not affected.

KBPF3A Installation Procedure

- Install the board on the standoffs you installed earlier as shown in Figure 96. The screws and lock washers needed are supplied with your KBPF3A Option kit. There are three connectors on the bottom of the KBPF3A board that must be properly mated to P44A, P44C and P44E on the RF board. Even though the connectors are hard to see if the KPA3A shield is installed, they can be aligned as follows:
- Set the KBPF3A board in place over the standoffs, aligning it so the holes in the KBPF3A board are aligned with the tops of the standoff. This will align the connectors.
 - Press down on the KBPF3A board to mate the connectors at the end near battery BT1 and along the side nearest the LPA board or, if installed, the KPA3A shield, while checking to ensure that the holes in the board are aligned with the holes in the standoffs. Note that simply installing the mounting screws will not ensure the 3-pin connectors are fully mated. When properly mounted the KBPF3A board should rest on top of the standoffs and be parallel with the RF board underneath.

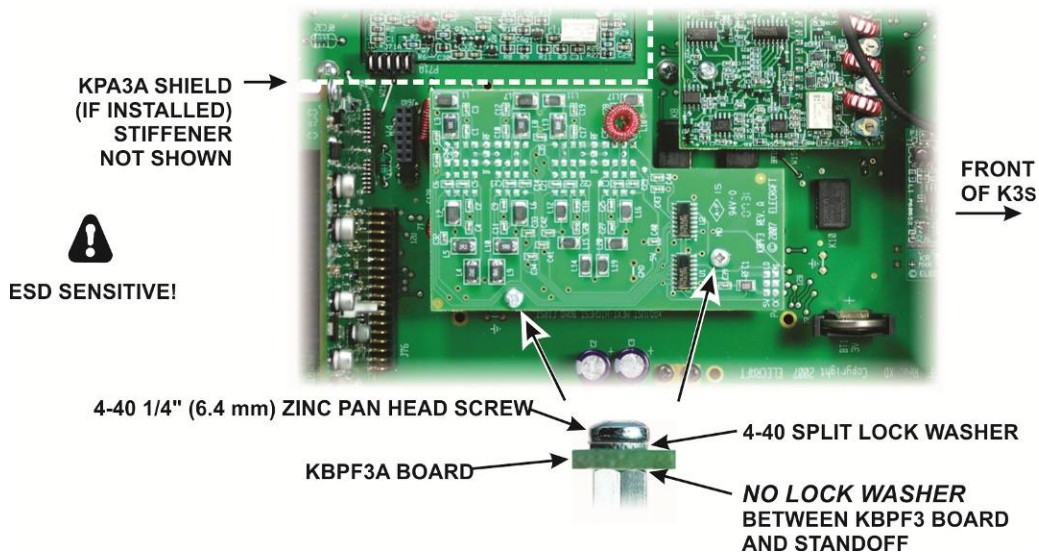

Figure 96. Installing the KBPF3A Option Board.

Power Amplifier Jumper Block

The Power Amplifier (PA) jumper block is required to operate the K3S without the optional KPA3A 100 watt power amplifier module installed. Your RF board was shipped with the jumper block installed. Even if you are planning to install the KPA3A at this time, do not remove it until instructed to do so. You will be performing some essential tests and calibration procedures before the KPA3A module is installed.

If you remove it for any reason before installing the KPA3A, replace it as shown in Figure 97. ***Inspect the position of the jumper block carefully to ensure it is mated with the four pins at the ends of both connectors. Your K3S may be damaged when power is applied if the jumper block is positioned incorrectly!***

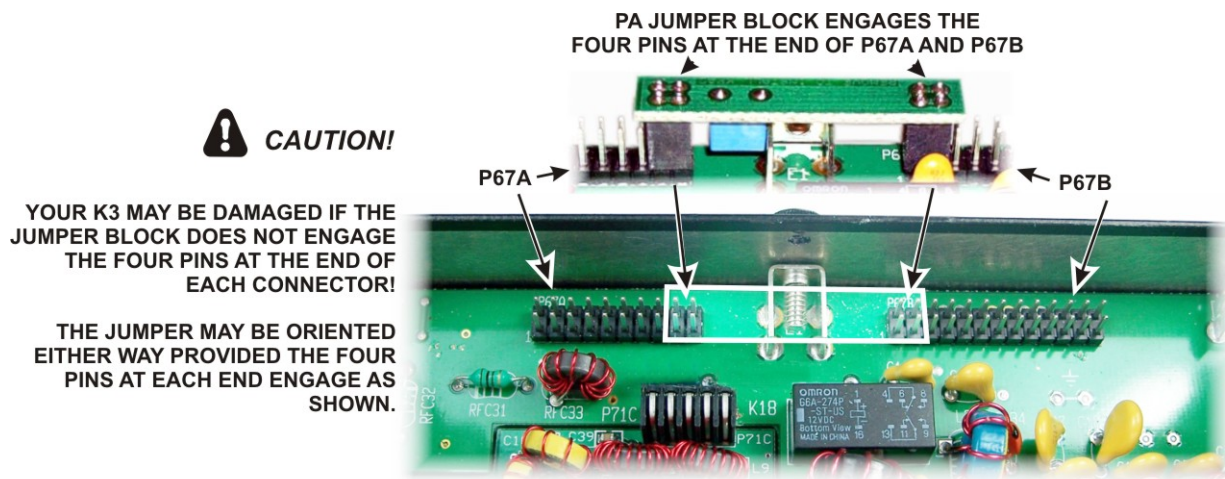

Figure 97. Installing the PA Jumper Block.

Battery BT1

Battery BT1 Installation Procedure

If you did not install the real time clock battery earlier, do so now.

- Remove the left side panel as shown in Figure 98.

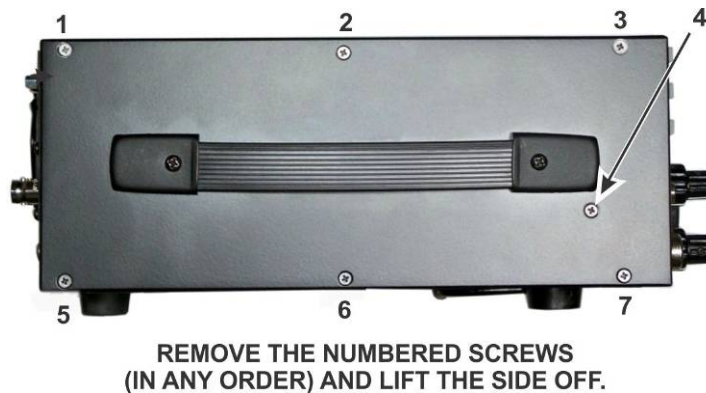

Figure 98. Removing the Left Side Panel.

- Insert the CR2032 cell into battery holder BT1 as shown in Figure 62 on page 45 . Be sure the positive side of the battery (marked with a +) is facing up.
- Replace the side panel. Be sure to replace all the screws including #4 in the photo.

Finishing the Enclosure

Even though you may be planning to install the KPA3A 100 watt amplifier at this time, you must complete the enclosure to run some essential tests and calibration procedures first. These tests require the enclosure panels be in place, particularly the bottom cover that acts as a heat sink for the low power amplifier (KLPA3A) transistors.

Fan Opening Cover

A large opening in the rear panel is provided for fans required to cool the KPA3A 100-watt amplifier module. If you did not purchase the KPA3A option with your kit, a blank panel is provided to cover this opening. If you purchased the KPA3A option with your kit, skip the following two steps and go directly to *AUX RF Cable* below.

The blank panel has a BNC connector hole marked ANT3. This is for the optional K144XV module. If you do not have the K144XV, press a BNC Hole Cover into the opening in the panel with the small, smooth end of the cover on the side of the panel that has the ANT3 label.

Install the panel in the opening on rear panel with a 3/16" (4.8 mm) black pan-head screw (SS) into the threaded bushing at each corner. Do not use washers under the screws.

AUX RF Cable

If you installed the AUX RF connector for the KRX3A sub receiver, that cable should be lying near the rear panel. If the KPA3A shield is installed it will be inside the shield. Check the cable carefully to ensure you have fully insulated the metal conductor at the end. Failure to do so may result in severe damage to your K3S if it comes in contact with a live circuit. Recommend you tape the cable to the rear panel or, if the KPA3A shield is installed, tape it to the shield to keep it secure inside the K3S.

Bottom Covers

Turn the K3S over so the bottom is exposed. Position the forward section of the bottom cover with the feet and bail toward the front as shown in Figure 99. Attach the cover with seven 3/16" (4.8 mm) black pan head screws (SS) at the positions shown. Do not use washers.

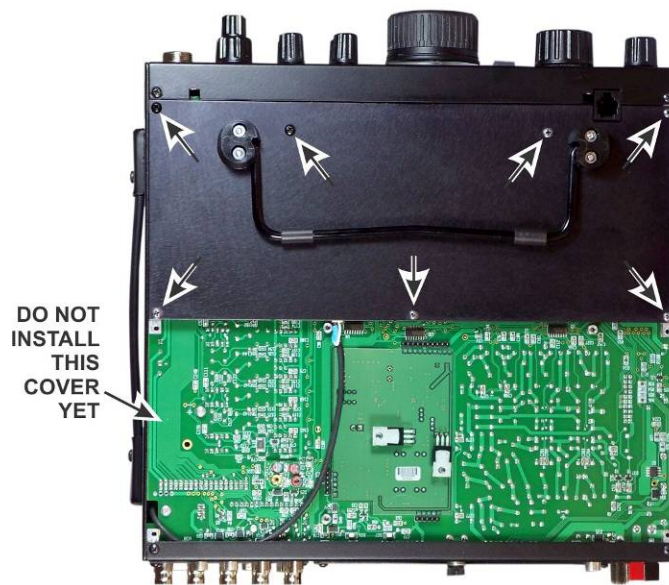

Figure 99. Installing Bottom Cover Forward Section.

□ Locate the two thermal insulators and clear the screw holes. They are already cut. If material is still covering the holes, push a small tool through the hole to remove the unwanted material. Remove the protective backing from each insulator and press the adhesive side against a low-power amplifier transistor with the hole in the insulator aligned with the screw hole in the transistor as shown in Figure 100. Take care not to disturb the position of the transistors over the standoffs.

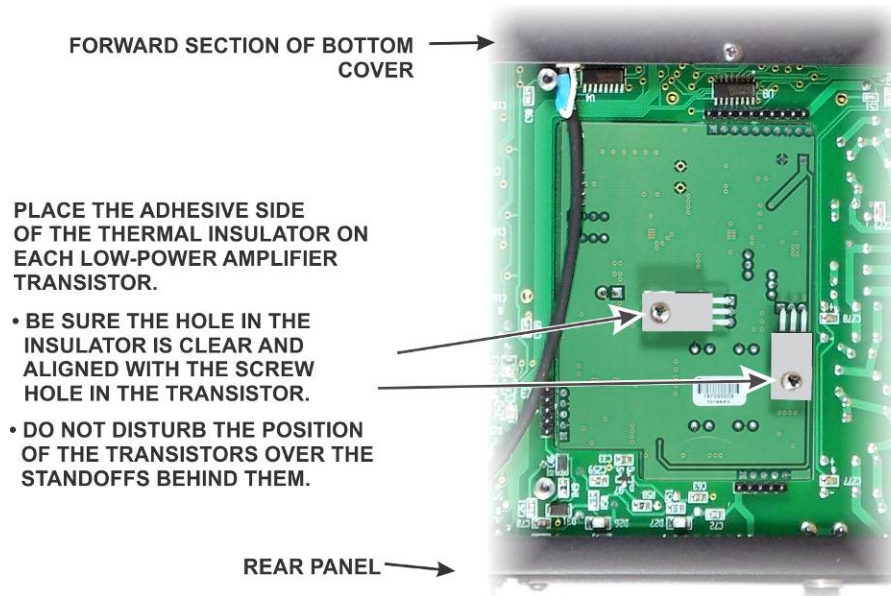

Figure 100. Installing the KLPA3A Transistor Thermal Insulators.

Install the rear bottom cover section as follows (see Figure 101):

- Be sure the KXV3B cable going to P86 is not on top of one of the LPA transistors where it would become trapped between the bottom cover and the transistor.
- Position the cover so the holes near the center line up with the transistors on the LPA board. The remaining holes will line up with 2D fasteners and standoffs.

Note: The bottom cover is anodized, not painted. There is a circular area around two holes on the inside surface that was masked to retain the bare metal. This circular area may not cover the entire area of the thermal insulators of both transistors. That is normal. The thermal insulators will efficiently transfer the heat even if part extends onto the anodized area.

- Start two 4-40 1/4" (6.4 mm) black pan head screws (SS) into the transistors through the holes near the center with a #4 internal tooth lock washer under each screw head. Do not tighten the screws yet.
- Start seven 4-40 3/16" (4.8 mm) black pan head screws (SS) into the remaining holes. Do not use washers.
- Tighten all nine screws.

CAUTION! IF INTERNAL TOOTH LOCK WASHERS ARE NOT INSTALLED UNDER THE SCREWS SHOWN THE POWER TRANSISTORS MAY FAIL.

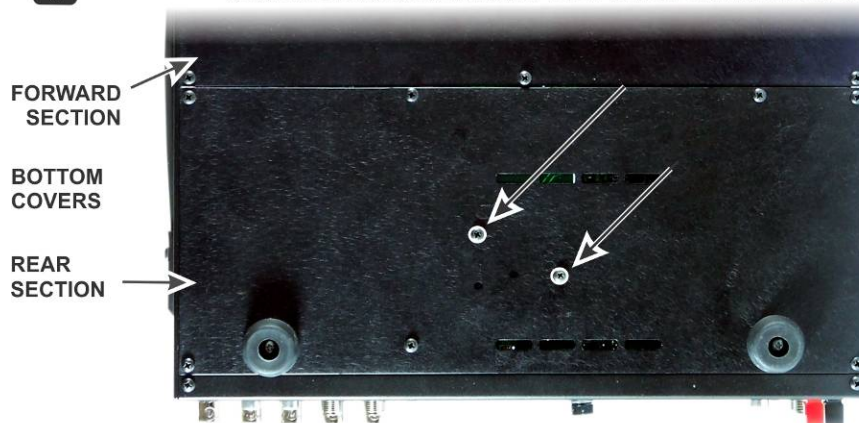
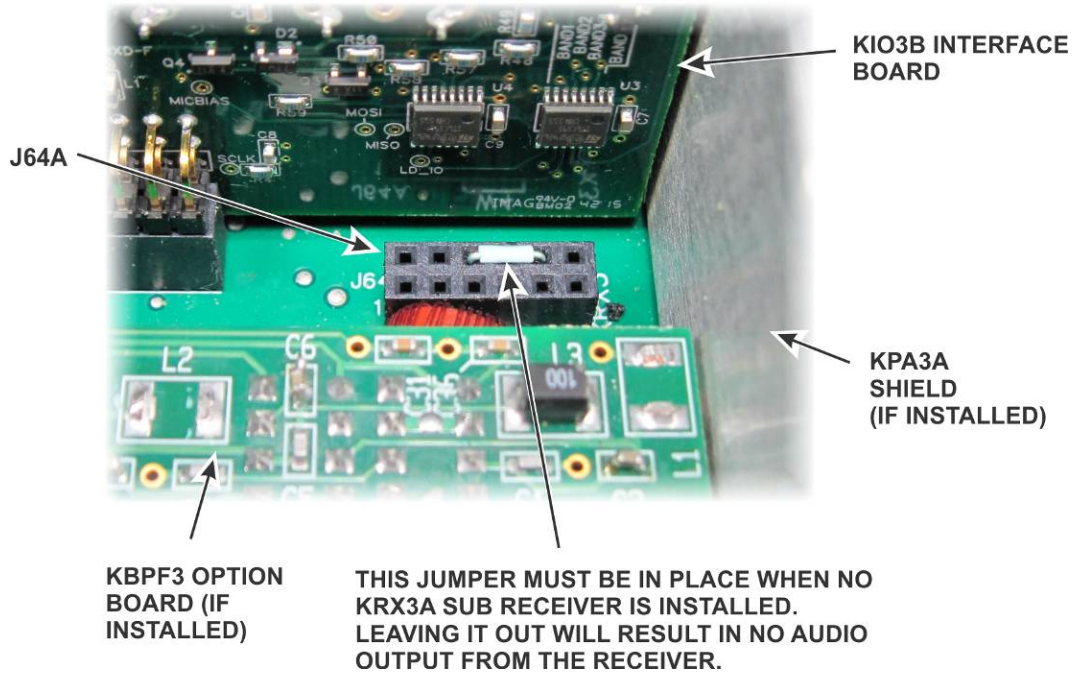

Figure 101. Checking Power Transistor Mounting Hardware.

Inspect the bottom cover screws to ensure you have internal tooth lock washers under the screws shown in Figure 101. **Be sure both screws are tight.** Some bottom covers may have an extra hole that is not used.

⚠ *There may be a small round screw hole in the bottom cover that is not used. That is normal.*

Turn the K3S over and set it on its bottom feet. Check to ensure the jumper shown in the figure below is installed on connector J64A. The connector is directly in front of the KIO3B board in the left rear corner when the K3S front panel is toward you. The jumper is normally installed at the factory and must be in place or you will not hear any receiver audio. If it is missing, fashion a replacement from a short length of wire. Be sure it is in the connector holes shown.



Top Cover

Even if you have the KPA3A 100-watt module to install, install the top cover and speaker at this time for initial testing and calibration of the basic 10-watt K3S configuration.

Lay the top cover on the K3S and connect the speaker cable to P25 of the KIO3B board as shown in Figure 102. If you have the KPA3A shield installed, route the speaker wire under the stiffener bar.

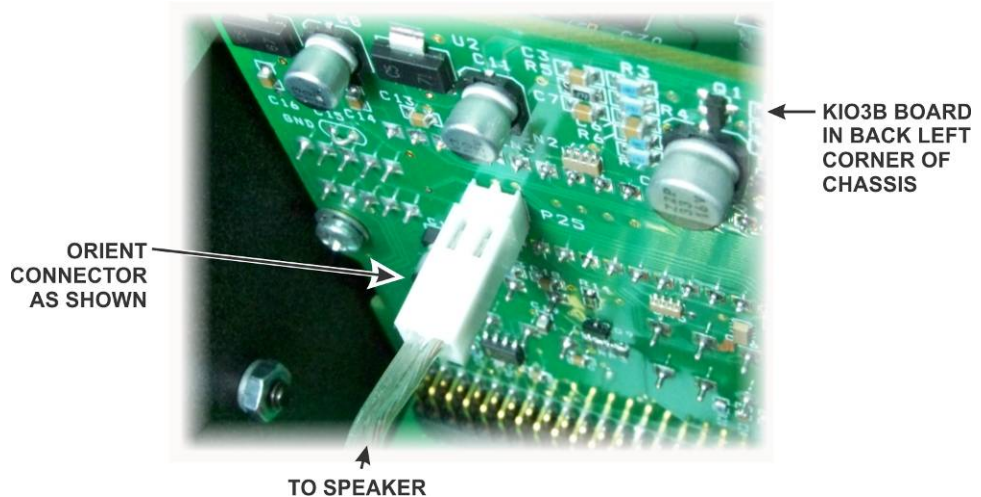

Figure 102. Connecting Speaker to KIO3B Board.

☐ Position the top cover on the K3S with the tab at the rear extending under the lip of the rear panel. Secure the top cover with six 4-40 3/16" (4.8 mm) black flat head screws (SS) along the front and rear edges of the cover. You may find it necessary to loosen screws at the top of the side, front and rear panels to adjust their position so the top cover fits properly.

☐ If you have the KPA3A shield installed, place three 4-40 3/16" (4.8 mm) black flat head screws (SS) through the holes across the middle of the cover to secure it to the stiffening bar. If you have not installed the KPA3A shield, the stiffening bar is still attached to the top cover where you mounted it to measure the speaker grill cloth for trimming. Place a 4-40 3/16" (4.8 mm) black flat head screw (SS) into each side panel to secure the ends of the stiffening bar.

⚠ *The screws that hold the top cover in place are an important part of the structural design that provides excellent structural rigidity in spite of its light weight. Be sure all the screws are in place and tight whenever you replace the cover or other panels.*

When removing the top cover in the future, the normal procedure is to remove the nine screws on top, leaving the stiffening bar on the chassis (see Figure 103). If the KPA3A 100-watt amplifier is installed, this is the only way the top cover can be removed because the rear shield installed with the KPA3A attaches to the stiffening bar.

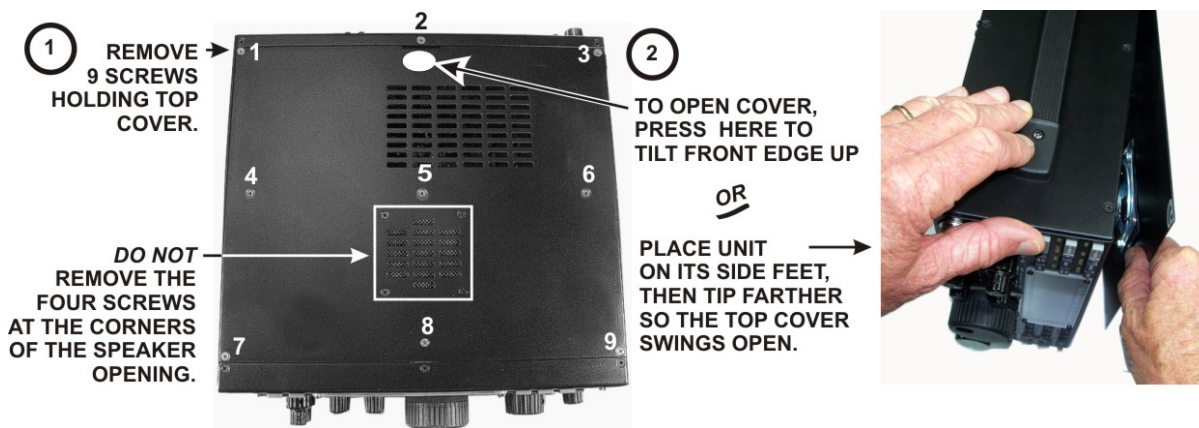

Figure 103. How to Remove the Top Cover.

This completes the assembly of your K3S/10 Transceiver. Next perform the Initial Test and Calibration procedures below to ensure your K3S is operating properly. Once they have been completed you can proceed to install other options, including the KPA3A 100-watt amplifier module, at any time. Each option is supplied with its own installation manual.

⚠ PARTS LEFT OVER?

You may find that you have extra screws, washers or nuts after completing the assembly of your K3Ss. This is normal. Extras of parts most easily lost during assembly are frequently included.

Test and Calibration

It's time to apply power! In the following tests and procedures you will check out and calibrate essential functions of your basic K3S. You must complete these procedures before operating your K3S at low power or before installing a KPA3A 100-watt power amplifier option.

Have your K3S Owner's Manual handy. Detailed procedures are in your Owner's Manual where you can find them easily in the future if you need them.

⚠ YOUR K3S WILL NOT OPERATE, OR WILL NOT OPERATE CORRECTLY, until you complete the Test and Calibration procedures below, including:

- **Filter Setup (all five procedures listed for *each* filter installed).**
- **Reference Oscillator Calibration.**
- **TX Gain Calibration on *all* bands.**

⚠ Using Tap/Hold Switches: Most K3S switches have two functions. *Tapping* activates the function labeled on the switch. *Holding* (~1/2 sec.) activates the function labeled beneath the switch.

Initial Power Checks

Connect your 13.8 VDC nominal (11-15 VDC) power supply to the red and black 12VDC IN connector on the back of your K3S. Don't connect anything else to your rig until instructed to do so.

On the front panel, tap **POWER** to turn the K3S on. The LCD display should illuminate as it did before. It will probably show an error message, e.g. ERR PLL or ERR PL1. This is normal! It is reporting that the synthesizer has not been calibrated. Tap **DISP** (display) to clear the error message. Other error messages may follow, depending upon which modules you have installed, indicating that they have not been initialized yet. Press display until you have cleared the error messages.

⚠ Always turn your K3S off by pressing the **POWER button. Removing DC power while the K3S is on can, on rare occasions, result in corrupted data in the EEPROM requiring you to reload the firmware.**

⚠ If you hear nothing in the speaker when first applying power to your K3S (and no headphones plugged in) hold **CONFIG to access the configuration menu, then rotate VFO B to display **SPKR+PH**. Tap **1** on the numeric keypad until you see **PH.R SW** — and exit the menu.**

Synthesizer Check

Hold **CONFIG** to access the configuration menu, then rotate VFO B to display **TECH MD**. Set the **TECH MD** parameter to **ON** with VFO A.

Tap **MENU** to exit the menu and then tap **DISP** on the K3 front panel.

Rotate the VFO B knob to display **SYN1** in the VFO B area of the display. You should see the status **OK**.

⚠ If you see characters other than **OK for the status, the synthesizer is not working properly. Note the exact display and contact Customer Service and Support (see page 5) Be sure you turned to **SYN1** and not **SYN2**. Synthesizer **SYN2** is part of the **KRX3A** sub receiver. You will see **SYN3*FF** when turning the VFO B knob to **SYN2**.**

Filter Setup

Turn to the *Crystal Filter Installation and Setup* section of your Owner's Manual and perform the following procedures. If you have installed standard Elecraft 5-pole filter(s) you will need the FREQ OFFSET data you recorded earlier on page 32.

- *Filter Bandwidth Setup*
- *Filter Center Frequency Setup*
- *Receive Filter Enables*
- *Filter Loss Compensation*
- *Transmit Filter Selection*

⚠ The transmit filter selection setup requires that you select a valid transmit filter for each mode. If you fail to do so, you will see ERR TXF and have no RF output when you attempt to transmit.

Reference Oscillator Calibration

Turn to the *Calibration Procedures, Reference Oscillator* section in your Owner's manual and perform either of the reference oscillator calibration procedures found there. One of the procedures uses an off-air signal and requires no external test equipment. If you installed the K3EXREF option, refer to *Using the K3EXREF* on page 4 of the *K3EXREF Frequency Lock Option* manual for testing and operating instructions.

TX Gain Calibration

If you do not have a computer, turn to the *Calibration Procedures, Transmitter Gain* section in your Owner's manual and perform the manual *Low-Power (5W) TX Gain Calibration* procedure.

⚠ Note: If you perform the manual procedure in the Owner's manual, when you press ANT to select ANT1 or press BYPASS to put the ATU in bypass mode, the display will read NO ATU even if you have installed the KAT3A ATU module. If you have installed the KAT3A ATU, it will be enabled next section after this calibration is done.

If you have a Windows, Linux or Macintosh computer with an RS232 interface and cable, and an internet connection, perform the automated TX Gain calibration using the K3 Utility program as follows:

Install the Elecraft K3 Utility Ver. 1.1.12.29 or later on your computer. The utility is available for downloading from the Elecraft web site: www.elecraft.com

Connect your computer to the RS232 port and start the K3 Utility program.

Click on the K3 Utility Calibraton tab, Calibrate Transmitter Gain... and perform the 5-Watt Transmitter Gain Calibration.

Option Modules

Enable Modules

Enable the KXV3B i/o module and, if installed, the KBPF3A general coverage bandpass filter, KAT3A ATU, and KDVR3 voice recorder option modules as described in the *Module Enables* section of your Owner's Manual. Even though they are installed, these modules will not function until they are enabled.

KPA3A 100-Watt Amplifier Installation

If you purchased the KPA3A 100-watt amplifier option, turn to the *KPA3A Option Installation Instructions* manual *Installation Procedure* to complete installation and testing now.

KRX3A Sub Receiver Installation

If you purchased the KRX3A sub receiver, turn to the *KRX3A High-Performance Sub Receiver Installation and Operation* manual to complete the installation. Since you have already installed the Auxiliary DSP board, begin with the section *Checking and Modifying Resistor R91* and continue on with all the steps to the end of the manual.

Other Calibration Procedures

Wattmeter Calibration (Optional)

The wattmeter is reasonably accurate as it is supplied. However, if you have an accurate external wattmeter you can adjust the K3S to match its readings at low power (5 watts), high power (50 watts), and at 0.5 milliwatts output at the KXV3B transverter interface. Refer to *Calibration Procedures, Wattmeter* in your Owner's Manual.

S-Meter Calibration (Optional)

The S-meter calibration is normally quite accurate with the default settings provided. If you have an accurate 50-ohm, 50-microvolt signal generator (such as the Elecraft XG1 or XG2) you can calibrate the S-meter yourself. Refer to *Calibration Procedures, S-Meter* in your Owner's manual.

Appendix A Illustrated Parts List

Your kit contains a number of envelopes, boxes and packages of parts. Check the contents of each one carefully against the following lists. Doing so will not only ensure no parts are missing, but it will also familiarize you with the appearance of each part that helps the kit assembly go smoothly and quickly.



You may find extra small parts included in your kit. The quantities specific are those required. Also there is a small bag marked Spares containing more extra parts. If a part is missing, contact Elecraft for a replacement (see *Customer Service and Support* on page 1).

Parts for Your Specific Kit

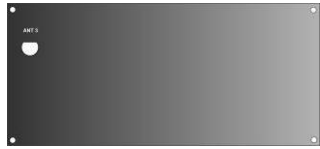

Depending upon the options you chose for our K3s, certain parts may be supplied or omitted as needed. One of the first things you removed from the box was a smaller box containing these parts as described below. Some options such as the KPA100 KAT3 Automatic Antenna Tuner are supplied in separate boxes with their own parts lists. They are not shown here. As you assemble your K3s, you will be directed to install those options or prepare your K3s for them to be installed after initial testing and checkout at the proper points in the assembly procedure.

ILLUSTRATION	DESCRIPTION	QTY	ELECRAFT PART NO.
	<p>KANT3 Antenna Input Module.</p> <p>Not supplied if you purchased the KAT3A automatic antenna tuner option with your K3s kit.</p> <p>The KAT3A replaces the KANT3.</p> <p>NOTE: Not all component positions on the board are filled. That is the result of design improvements.</p>	1	E850248
	<p>Panel, Blank (KPA3 Fans)</p> <p>Not supplied if you purchased the KPA 100 watt amplifier option with your K3s kit.</p>	1	E850297

E850323 KREF3 TCXO Module Bag





ILLUSTRATION	DESCRIPTION	QTY	ELECRAFT PART NO.
	KREF3 TCXO Module, 49.380 MHz, ±5 ppm stability This module is not supplied if you purchased the optional ±1 ppm module shown below.	1	E660033
	Tie Wrap, KREF3 TCXO. Module	1	E980145

KTCX03-1 TCXO Module Bag

ILLUSTRATION	DESCRIPTION	QTY	ELECRAFT PART NO.
	KREF3 TCXO Module, 49.380 MHz, ±1 ppm stability. (optional)	1	KTCX03-1
Rectangular Insulator attached to the bottom of the TCXO Module	TCXO spacer (supplied only with optional KTCX03-1 module)	1	E980146
	Tie Wrap, KREF3 TCXO. Module	1	E980145

Crystal Filter (in bag)

Depending upon what filters you ordered with your K3S, you will have either 5-pole or 8-pole filters packed with your kit. At least one filter is required for the K3S to operate.

ILLUSTRATION	DESCRIPTION	QTY	ELECRAFT PART NO.
	Typical 5-pole filter.	Up to 5 may be installed in a K3s	Depends upon the Filter Bandwidth
	Typical 8-pole filter.		
	Screw, 4-40, either 1/4" (6.4 mm) Zinc, Pan Head. Screw may be inserted into a threaded bushing in the bottom of the filter board with the washer below.	1 per filter	E700005
	Lock Washer, #4, Interior Tooth.	1 per filter	E700010

Parts Included in All K3S Kits

These parts are in a box with a label identifying the contents as a K3S kit and whether it is a K3S/10 (10 watt) or K3S/100 (includes the optional 100 watt KPA100 amplifier).

Your kit should include all of the following parts regardless of the options you chose. Note that there are two additional boxes. One box contains the large K3S BSF (main RF board) (see page A-13) and the other box contains the chassis set (see page A-15).

Printed Circuit Boards

Each board is packaged in its own ESD-safe bag identified by the part numbers shown below. The photographs are provided to help you identify each board. You may find that some of the components or component locations on the boards you receive are slightly different from those shown.

⚠ CAUTION!

DO NOT DISTURB ANY ADJUSTMENTS ON THE BOARDS

Each board was tested and aligned for optimum performance at the factory. Any change to these adjustments will degrade the performance of your K3S or prevent its operation altogether. All user calibrations and adjustments are done in firmware using the front panel menus. These are described at the appropriate points in the assembly procedures and in the Owner's Manual.



ILLUSTRATION	DESCRIPTION	QTY	ELECRAFT PART NO.
	Front Panel Printed Circuit Board Assembly ⚠ <i>ESD Sensitive</i>	1	E850242
	K3s DSP Printed Circuit Board Assembly ⚠ <i>ESD Sensitive</i>	1	E850233

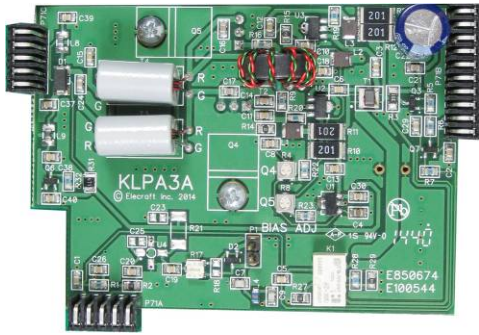
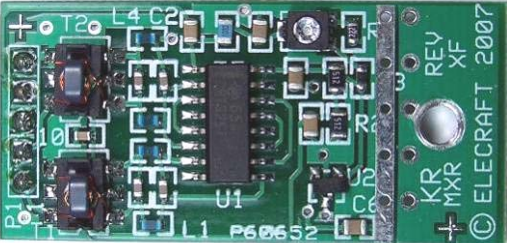
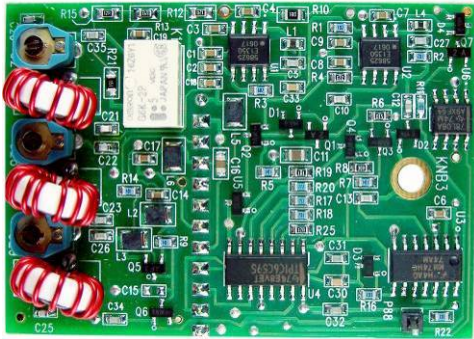
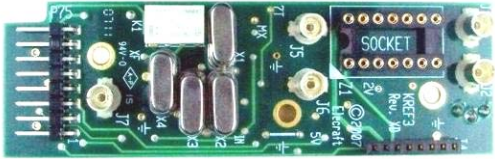

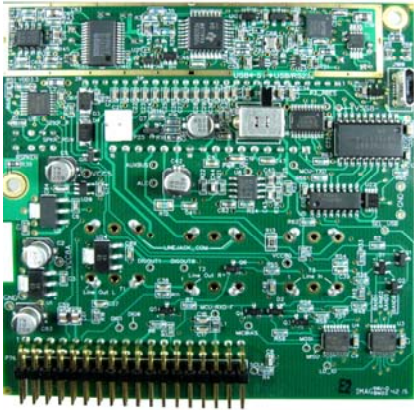

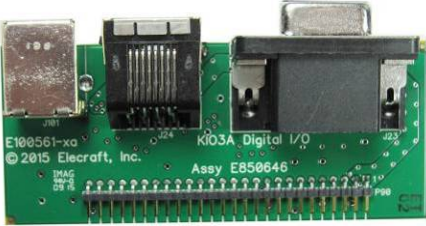
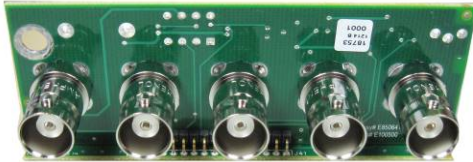



ILLUSTRATION	DESCRIPTION	QTY	ELECRAFT PART NO.
 <p>The image shows a green PCB assembly for the KLPA3A. It features a central integrated circuit, several electrolytic capacitors, and various resistors. The board is populated with components and has labels such as 'KLPA3A', 'E16-2M-0', and 'E50674'.</p>	<p>KLPA3A (Low Power Amplifier) PCB Assembly ⚠ ESD Sensitive.</p>	1	E850674
 <p>The image shows a green PCB assembly for the K3s Mixer. It includes a central IC, several electrolytic capacitors, and various resistors. Labels on the board include 'K3s', 'REY XF', 'MXR', and 'ELECRAFT 2007'.</p>	<p>K3s Mixer PCB Assembly ⚠ ESD Sensitive.</p>	1	E850257
 <p>The image shows a green PCB assembly for the KNB3 Noise Blanker. It features a central IC, several electrolytic capacitors, and various resistors. Labels on the board include 'KNB3', 'R15', 'R12', 'R10', 'R1', 'R3', 'R4', 'R5', 'R6', 'R7', 'R8', 'R9', 'R11', 'R13', 'R14', 'R16', 'R17', 'R18', 'R19', 'R20', 'R21', 'R22', 'R23', 'R24', 'R25', 'R26', 'R27', 'R28', 'R29', 'R30', 'R31', 'R32', 'R33', 'R34', 'R35', 'R36', 'R37', 'R38', 'R39', 'R40', 'R41', 'R42', 'R43', 'R44', 'R45', 'R46', 'R47', 'R48', 'R49', 'R50', 'R51', 'R52', 'R53', 'R54', 'R55', 'R56', 'R57', 'R58', 'R59', 'R60', 'R61', 'R62', 'R63', 'R64', 'R65', 'R66', 'R67', 'R68', 'R69', 'R70', 'R71', 'R72', 'R73', 'R74', 'R75', 'R76', 'R77', 'R78', 'R79', 'R80', 'R81', 'R82', 'R83', 'R84', 'R85', 'R86', 'R87', 'R88', 'R89', 'R90', 'R91', 'R92', 'R93', 'R94', 'R95', 'R96', 'R97', 'R98', 'R99', 'R100'.</p>	<p>KNB3 Noise Blanker PCB Assembly ⚠ ESD Sensitive.</p>	1	E850280
 <p>The image shows a green PCB assembly for the KREF3. It includes a central IC, several electrolytic capacitors, and various resistors. Labels on the board include 'KREF3', 'SOCKET', and 'ELECRAFT 2007'.</p>	<p>KREF3 PCB Assembly ⚠ ESD Sensitive.</p>	1	E850254

ILLUSTRATION	DESCRIPTION	QTY	ELECRAFT PART NO.
 <p>A green printed circuit board (PCB) assembly labeled 'KSYN3A'. It features various electronic components including a 49.38 MHz crystal, a 3V regulator, and several connectors. The board is populated with surface-mount components and has a gold-plated edge connector.</p>	<p>KSYN3A Assembly ⚠ ESD Sensitive</p>	1	E850638
 <p>A complex green PCB assembly labeled 'KIO3B Main PCB Assembly'. It is densely packed with numerous integrated circuits, capacitors, and other electronic components. It features a large gold-plated edge connector at the bottom.</p>	<p>KIO3B Main PCB Assembly ⚠ ESD Sensitive.</p>	1	E850645
 <p>A green PCB assembly labeled 'KIO3B Audio I/O PCB Assembly'. It features a gold-plated edge connector and several audio connectors (XLR and TRS). The board is populated with audio-related components.</p>	<p>KIO3B Audio I/O PCB Assembly ⚠ ESD Sensitive.</p>	1	E850647
 <p>A green PCB assembly labeled 'KIO3B Digital I/O PCB Assembly'. It features a gold-plated edge connector and several digital I/O connectors. The board is populated with digital logic components.</p>	<p>KIO3B Digital I/O PCB Assembly ⚠ ESD Sensitive.</p>	1	E850646
 <p>A green PCB assembly labeled 'KXV3B PCB Assembly'. It features a gold-plated edge connector and several BNC connectors. The board is populated with RF-related components.</p>	<p>KXV3B PCB Assembly ⚠ ESD Sensitive.</p>	1	E850644

Miscellaneous Components

Packed in separate bags and envelopes as follows:

E850305 K3s Knobs for Front Panel (bag)

ILLUSTRATION	DESCRIPTION	QTY	ELECRAFT PART NO.
	Knob, VFO B Tuning	1	E980090
	Knob, RIT/XIT	1	E980089
	Knob, Concentric Shaft, Large	2	E980092
	Knob, Concentric Shaft, Small	2	E980091

E850308 K3s Front Panel Knobs , Set of 4 (bag)

ILLUSTRATION	DESCRIPTION	QTY	ELECRAFT PART NO.
	Knob, Small Encoder Shaft	4	E980088

E850239 K3s FP Encoder Assembly Bag

ILLUSTRATION	DESCRIPTION	QTY	ELECRAFT PART NO.
	K3s FP Encoder Assembly	2	E850239

E850697 K3s Knob and Band for VFO A (bag)

ILLUSTRATION	DESCRIPTION	QTY	ELECRAFT PART NO.
	Knob, VFO A Tuning	1	E980093
	Finger Grip, Main VFO Tuning Knob	1	E980285

E850698 K3s Front Panel Bezels and Serial Number Label (bag)

ILLUSTRATION	DESCRIPTION	QTY	ELECRAFT PART NO.
	Bezel Lens (LCD cover), K3s	1	E100575
	Bezel K3s	1	E100566
	Serial Number Label (supplied in envelope marked E850699)	1	E850700

E850712 K3s RF Misc. Bag

You will find bags included inside this bag. Where a bag or envelope inside this bag contain several parts with individual part numbers, they are listed on separate tables following this one. In addition there is a small bag marked K3s Hardware Spares Bag. It contains a collection of small parts that are easily lost. Normally you will not need any of the parts it contains to build your kit.













ILLUSTRATION	DESCRIPTION	QTY	ELECRAFT PART NO.
	TMP Cables, 5" (13 cm)	3	E100282
	Lithium Battery, 3V (in envelope)	1	E850058
	Loudspeaker Grill Cloth	1	E850089
	#4 Fiber Washer	4	E700031
 <p data-bbox="300 1071 511 1102">Front Feet with Stand</p> <p data-bbox="349 1176 462 1207">Rear Feet</p>	Bottom Feet with tilt stand	1	E980098
	SO239 Hole Cover	1	E980135
	BNC Hole Cover	3	E980136
	Thumbscrew, #6	1	E700070
	2D Fastener	10	E100078
	Thermal Insulator (inside small envelope)	2	E850411

ILLUSTRATION	DESCRIPTION	QTY	ELECRAFT PART NO.
<p data-bbox="272 226 548 289">Typical Standoffs (May be round or hexagonal)</p> 	Standoff, 4-40, 1/4" (6.4 mm) long	6	E700026
	Standoff, 4-40, 3/8" (9.5 mm) long	2	E700153
	Standoff, 4-40, 1/2" (13 mm) long	3	E700061
<p data-bbox="284 527 532 548">Typical Pan Head Screws</p>  <p data-bbox="305 657 354 678">Zinc</p> <p data-bbox="451 657 500 678">Black</p>	Screw, 4-40, 1/4" (6.4 mm) Zinc, Pan Head	20	E700005
	Lock Washer #4, Split	36	E700004
	Lock Washer, #4, Interior Tooth	18	E700010
	Nut, 4-40	18	E700011
	Washer, Flat, #6	2	E700067
	Grommet Bumper, 7/16" Round (Side panel feet)	4	E980141
	Coaxial Cable, TNP to 2 pin	1	E850292

E850713 KXV3B Hardware

ILLUSTRATION	DESCRIPTION	QTY	ELECRAFT PART NO.
	Lock Washer, #4, Internal Tooth	2	E700010
	4-40 Nut, Hex	2	E700011
	Screw, 4-40, 1/2" (13 mm) Black Pan Head	2	E700177



E850714 Stainless Steel (SS) Hardware (in K3S RF Misc Bag)

ILLUSTRATION	DESCRIPTION	QTY	ELECRAFT PART NO.
	Screw, 4-40, 3/16" (4.8 mm) Black Flat Head	26	E700173
	Screw, 4-40, 3/8" (9.5 mm) Black Flat Head	7	E700176
	Screw, 4-40, 1/2" (13 mm) Black Flat Head	1	E700178
<p>Typical Pan Head Screws</p>   <p>Zinc Black</p>	Screw, 4-40, 7/16" (11 mm) Zinc Pan Head	7	E700181
	Screw, 4-40, 1/4" (6.4 mm) Black Pan Head	2	E700121
	Screw, 4-40, 3/16" (4.8 mm) Black Pan Head	22	E700172
	4-40 Nut, Hex	10	E700204
	Lock Washer Internal Tooth	13	E700183
	Standoff, 4-40, 5/16" (7.9 mm) Long	1	E700121



E850067 Allen Wrench Envelope (in K3S RF Misc Bag)

ILLUSTRATION	DESCRIPTION	QTY	ELECRAFT PART NO.
	Allen Wrench, 5/64" (in envelope)	1	E980004
	Allen Wrench, .050" (in envelope)	1	E980008





E850717 K144XV Side Panel Hardware Envelope (in K3S RF Misc Bag)

ILLUSTRATION	DESCRIPTION	QTY	ELECRAFT PART NO.
	Screw, 6-32, 1/4" (6.4 mm) Black Flat Head	3	E700185
	Lock Washer, #6, Internal Tooth	3	E700095
	Nut, 6-32	3	E700069

E850680 KSYN3A Envelope (in K3S RF Misc Bag)

ILLUSTRATION	DESCRIPTION	QTY	ELECRAFT PART NO.
	Screw, 4-40 1/4" (6.4 mm) Zinc, Pan Head	2	E700005
	Lock Washer, #4, Internal Tooth	2	E700010

E850229 SO239 Ant Connector Assembly Bag (in K3S RF Misc Bag)



ILLUSTRATION	DESCRIPTION	QTY	ELECRAFT PART NO.
	SO239 (UHF) Female Panel Mount Connector with cable	1	E850229
	Screw, 4-40, 1/4" (6.4 mm) Black, Pan Head	4	E700174
	Lock Washer, #4, Interior Tooth	2	E700010
	Nut, 4-40	2	E700011

E850709 Front Panel Hardware Bag







ILLUSTRATION	DESCRIPTION	QTY	ELECRAFT PART NO.
	Felt Washer	3	E700033
	Knurled Nut (Phones Jack)	1	E700138
<p data-bbox="326 646 488 674">Typical Standoffs</p> 	Standoff, 2/56, 5/16" (7.9 mm) long	2	E700122
	Standoff, 4-40, 5/16" (7.9 mm) long	2	E700121
	Standoff, 4-40, 5/8" (15.9 mm) long	3	E700003
	Standoff, Nylon, 5/8" (15.9 mm) long	1	E700163
	Screw, 4-40, 3/16" (4.8 mm) Black, Flat Head	1	E700173
	Screw, 2-56, 1/4" (6.4 mm) Black, Pan Head	2	E700124
	Screw, 4-40, 1/4" (6.4 mm) Zinc, Pan Head	9	E700005
	Lock Washer, #2, Split	2	E700123
	Lock Washer #4 Split	9	E700004
	Nut, 1/2" (13 mm) Hex	6	E700125
	Lock Washer, 1/2" (13 mm) Interior Tooth	5	E700150
	Washer, Flat, Phones Jack Spacer	1	E700145
 <p data-bbox="321 1688 488 1715">(Soft Foam Strips)</p>	Front Panel Light Blocker (2 strips in envelope)	1	E850324

E850710 LCD Bezel Screws (in Front Panel Hardware Bag)



⚠ Do not mix these screws up with other parts in the Front Panel Hardware bag. Confusing them with other screws nearly the same length may destroy your front panel board. They are packaged separately for your convenience. You will be instructed when to use each screw in the assembly procedure.

ILLUSTRATION	DESCRIPTION	QTY	ELECRAFT PART NO.
	Screw, 4-40, 5/16" (7.9 mm) Black, Flat Head	1	E700249
	Screw, 2-56, 5/16" (7.9 mm) Fillister Head	2	E700312
	Screw, 2-56, 5/32" (6.4 mm) Fillister head	4	E700311





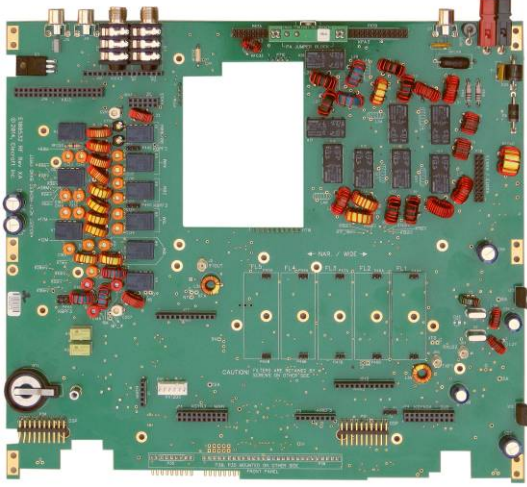

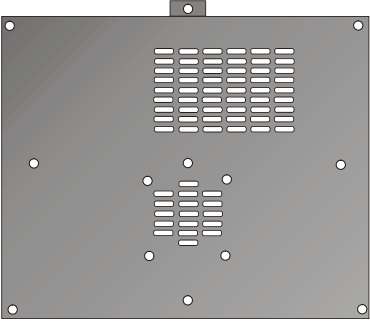

E850716 KIO3B Hardware Bag

ILLUSTRATION	DESCRIPTION	QTY	ELECRAFT PART NO.
	Screw, 4-40, 1/4" (6.4 mm) Black, Pan Head	2	E700174
	Screw, 4-40, 1/4" (6.4 mm) Zinc, Pan Head	2	E700005
	Lock Washer, #4, Interior Tooth	2	E700010
	Lock Washer #4 Split	2	E700004
	Jackscrew Nut, 4-40 Note: The jackscrew nuts may be mounted on the DB-9 connector on the Digital I/O Board.	2	E700078
	Standoff, 4-40, 1-1/4" (31.8 mm) long	2	E700119

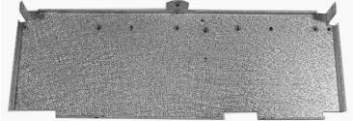
E850695 K3s RF BSF Assembly (in box)

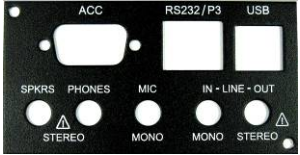
	<p>RF Board </p>	<p>1</p>	<p>E850651</p>
	<p>PA Jumper Block Assembly (pre-installed on RF board)</p>	<p>1</p>	<p>E850325</p>

E850701 K3s Chassis Set (in box)

ILLUSTRATION	DESCRIPTION	QTY	ELECRAFT PART NO.
	Front Panel	1	E100557SS
	Top Cover	1	E100212
	Rear Panel	1	E100214SS
	Front Panel Shield	1	E100216
	Chassis Stiffener	1	E100222
	KIO3B Digital I/O Panel In bag marked E850702	1	E100558SS
	KXV3B Panel	1	E850704
	Loudspeaker with attached wire and connector	1	E850300
	Loudspeaker Shield	1	E980087



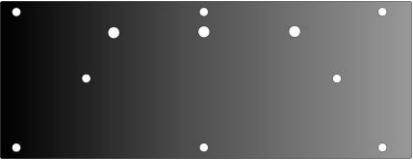
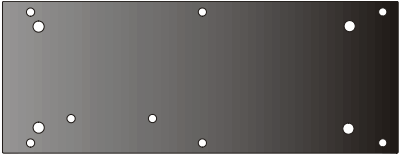

E850312 Side Panels

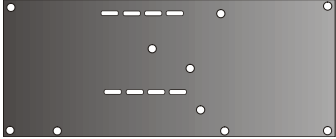
ILLUSTRATION	DESCRIPTION	QTY	ELECRAFT PART NO.
	Left Side Panel	1	E100210
	Right Side Panel	1	E100211



E850313 Bottom Covers (Wrapped)

ILLUSTRATION	DESCRIPTION	QTY	ELECRAFT PART NO.
	Bottom Cover A	1	E100213
	Bottom Cover B	1	E100221

E850718 Carrying Handle Bag

ILLUSTRATION	DESCRIPTION	QTY	ELECRAFT PART NO.
	Handle (strap, spring insert and two end caps)	1	E850719
	Screw, 6-32, 1/2" (13 mm), Black, Pan Head (in envelope)	2	E700180
	Lock Washer, #6, Internal Tooth	2	E700095
	Nut, 6-32 (in envelope)	2	E700069

Cables in Separate Bags

ILLUSTRATION	DESCRIPTION	QTY	ELECRAFT PART NO.
	Power Cable APP and Ring Terminals	1	KPCA-F
	RJ-45 to DE-9S	1	E980297
	USB A-B Cable	1	E850720