ELECRAFT KX1 TRANSCEIVER



OWNER'S MANUAL

ELECRAFT KX1

Ultra-Portable CW Transceiver

Owner's Manual

Revision E, May 21, 2010

Copyright © 2010 Elecraft, Inc.

All Rights Reserved

Table of Contents

INTRODUCTION	3
SPECIFICATIONS.....	5
PREPARATION FOR ASSEMBLY	6
ASSEMBLY - PART I.....	14
ALIGNMENT AND TEST - PART I	27
ASSEMBLY – PART II.....	30
ALIGNMENT AND TEST - PART II	43
ASSEMBLY - PART III.....	48
ALIGNMENT AND TEST - PART III	58
FINAL ASSEMBLY	60
OPERATION	62
KX1 OPTIONS.....	71
CIRCUIT DETAILS.....	72
PARTS LIST.....	APPENDIX A
SCHEMATIC	APPENDIX B
BLOCK DIAGRAM.....	APPENDIX C
PHOTOGRAPHS.....	APPENDIX D
TROUBLESHOOTING	APPENDIX E
PARTS PLACEMENT DRAWINGS	APPENDIX F
QUICK REFERENCE	APPENDIX G

Introduction

The Elecraft KX1 is a compact, multi-band CW transceiver optimized for backpacking and travel use. With internal battery, internal automatic antenna tuner, log-book lamp, and plug-in keyer paddle, it offers a high level of integration.

Unlike most transceivers, the KX1's controls are located on the top of the cabinet, and the keyer paddle attaches at the front. This "trail-friendly" format is ideal for hand-held or lap-top operation, e.g. when sitting on the ground, using a camp chair, reclining, or even standing. The KX1 is also at home on a table or desk, providing an optimal display viewing angle without the need for a tilt stand. The unique plug-in keyer paddle is both physically reversible for right- or left-handed use.

The transceiver covers the full 40 and 20 meter bands, and optionally 80 and 30 meters. The VFO is based on a DDS (direct digital synthesis) IC, so it can also tune well outside each band, covering many popular SWL band segments. A variable bandwidth crystal filter permits reception of SSB and AM as well as CW, facilitating cross-mode contacts and broadcast reception.

The KX1's internal six-cell battery pack can be changed in seconds with the removal of two thumb screws. The battery provides 1 to 2 watts power output, which represents a good tradeoff between battery life and communications efficiency. An external 12 V supply increases output to about 4 watts. Low receive-mode current drain (35 mA typ.) results in battery life of 20 hours or more. The low-battery warning threshold can be adjusted to match the battery type used.

The KX1 uses a 3-digit LED display that is physically rugged and extremely efficient. It requires just 1 to 2 milliamps total current in moderate lighting conditions, and about 10 mA at its brightest setting. The operator can optionally configure the display to turn off 5 to 60 seconds after any front-panel control has been used. Operation without the display is possible if the CW feedback feature is turned on (audio Morse code). This provides audible announcement for the VFO dial, menu text, and all controls.

Additional operating features include instant band selection, nine frequency memories, three VFO tuning rates, receive incremental tuning (RIT), USB/LSB receive on all bands, and an S-meter display mode. The built-in keyer offers Iambic modes A and B and two message buffers. In an emergency, two of the front panel switches can be configured for use as a manual key or keyer paddle.

Despite its compact size and many built-in accessories, the KX1 is easy to build. The basic unit consists of a single printed circuit board, with no surface mount components to install (the three surface mount parts used are pre-installed). Assembly and test are completed in phases to simplify any needed troubleshooting, and only a few alignment steps are required.

We'd like to thank you for choosing the KX1 transceiver, and hope it meets your expectations for ultra-lightweight portable operation.

Wayne Burdick, N6KR

Eric Swartz, WA6HHQ

Customer Service Information

Technical Assistance

If you have difficulty with kit construction, operation, or troubleshooting, we're here to help. You may be able to save time by first consulting our web site, www.elecraft.com, or by posting your question on the Elecraft e-mail forum, elecraft@mailman.qth.net.

Telephone assistance is available from 9 A.M. to 5 P.M. Pacific time (weekdays only) at 831-662-8345. You can also send e-mail to support@elecraft.com. *Please use e-mail, rather than call, when possible since this gives us a written record of the details of your problem.*

Repair Service

If necessary, you may return your completed kit to us for repair. **Contact Elecraft before mailing your kit to obtain the repair shipping address, as well as information on repair fees.** (Kits that have been soldered using acid core solder, water-soluble flux solder, or other corrosive or conductive fluxes or solvents cannot be accepted for repair—see Warranty.)

The following information should be provided to expedite repair: your name, address, and phone number; your e-mail address (if applicable); and a complete description of the problem.

Shipping: First, seal the unit in a plastic bag to protect the finish from dust and abrasion. Use a sturdy packing carton with 3" or more of foam or shredded paper on all sides. Seal the package with reinforced tape. (Neither Elecraft nor the carrier will accept liability for damage due to improper packaging.) Cover the "to" address label with clear tape.

Elecraft's 1-Year Limited Warranty

This warranty is effective as of the date of first consumer purchase (or if shipped from factory, date product is shipped to customer). It covers both our kits and fully assembled products. For kits, before requesting warranty service, you should fully complete the assembly, carefully following all instructions in the manual.

Who is covered: This warranty covers the original owner of the Elecraft product as disclosed to Elecraft at the time of order. Elecraft products transferred by the purchaser to a third party, either by sale, gift or other method, who is not disclosed to Elecraft at the time of original order, are not covered by this warranty. If the Elecraft product is being bought indirectly for a third party, the third party's name and address must be provided to Elecraft at time of order to insure warranty coverage.

What is covered: During the first year after date of purchase, Elecraft will replace defective or missing parts free of charge (post-paid). We will also correct any malfunction to kits or assembled units caused by defective parts and materials. Purchaser pays inbound shipping to Elecraft for warranty repair, Elecraft will pay shipping to return the repaired equipment to you by UPS ground service or equivalent to the continental USA and Canada. Alaska, Hawaii and outside U.S. and Canada actual return shipping cost paid by owner.

What is not covered: This warranty does not cover correction of kit assembly errors. It also does not cover misalignment; repair of damage caused by misuse, negligence, or builder modifications; or any performance malfunctions involving non-Elecraft accessory equipment. The use of acid-core solder, water-soluble flux solder, or any corrosive or conductive flux or solvent will void this warranty in its entirety. Also not covered is reimbursement for loss of use, inconvenience, customer assembly or alignment time, or cost of unauthorized service.

Limitation of incidental or consequential damages: This warranty does not extend to non-Elecraft equipment or components used in conjunction with our products. Any such repair or replacement is the responsibility of the customer. Elecraft will not be liable for any special, indirect, incidental or consequential damages, including but not limited to any loss of business or profits.

Specifications

General

Size (H x W x D)	
Cabinet	1.2 x 5.3 x 3.0" (3 x 13.5 x 8 cm)
Overall	1.4 x 5.8 x 3.0" (3.5 x 15 x 8 cm)
Weight	9 oz. (0.25 kg), excluding options
Supply voltage	7-14 V (8 V min. recommended)
Current drain	
Receive	35 mA typ., 40 mA max (headphones, LED display timed out, 30-m or 30/80-m option installed)
Transmit	300-700 mA (varies with supply voltage and power output setting)
Bands covered (MHz) ¹	
Receive	5.0-9.5 and 12.0-16.5 MHz
Transmit	7.000 to 7.300, and 14.000 to 4.350 MHz; <i>spurious content</i> at 3 to 4 w, 2 nd harmonic -40 dB typ. with LPF adjustment (see page 59)
Frequency control	DDS with 50 MHz crystal reference
VFO drift	< 50 Hz per hour after 5-minute warm-up at 25° C
Display	3-digit LED w/bargraph mode;

audio CW feedback on keypress

Transmitter

Max. power output (approx.)	
9 V supply	1.5-2 W
12 V supply	3-4 W
Spurious content	-40 dB @ 3 to 4 W
Load tolerance	2:1 or better SWR recommended
Sidetone pitch	500-650 Hz in 10 Hz steps
Keyer	8-50 WPM; Iambic modes A and B; 2 message buffers; auto-repeat

Receiver

Sensitivity	Approx. 0.2 μ V for 10 dB (S+N)/N
I.F.	4.915 MHz, single conversion
Selectivity	3-pole variable-bandwidth crystal filter, approx. 300-2000 Hz
Audio output	0.1 watt into 8-ohm load; stereo plug required

¹KXB30 option adds 8.0-12.5 MHz receive and 10.1-10.15 MHz transmit. The KXB3080 option covers the same range as the KXB30 and adds 1.5-5.5 MHz receive and 3.5-4.0 MHz transmit. Adding either module also greatly improves sensitivity in the 49-meter band (5.9-6.4 MHz).

Preparation for Assembly

Overview of the KX1

The KX1 chassis consists of a top and bottom cover (Figure 1). All components, including controls and connectors, are mounted on a single printed circuit board (PCB). Only three surface-mount components are required, and these are pre-mounted to the board.

The top cover is also the front panel. The controls face upward for convenient operation. The printed circuit board mounts directly behind the front panel.

The automatic antenna tuner option (KXAT1) plugs into the bottom of the main PC board at J6, J7 and J8. The optional keyer paddle (KXPD1) plugs into the Keyer/Paddle jack, J3, at the front edge of the top cover.

The bottom cover is held in place by two thumbscrews. Two three-cell AA battery sockets are attached to the bottom cover and are wired in series to form a six-cell pack. The battery voltage is 7.2 or 9 V depending on the battery type.

Appendix D provides close-up views of the top and bottom of the assembled PC board.

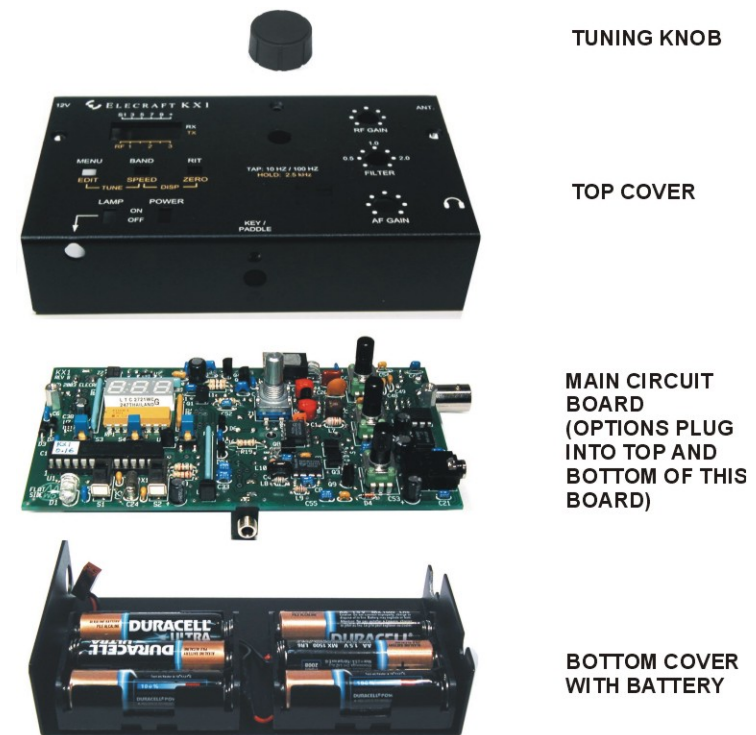

Figure 1. KX1 Overview.

Unpacking and Inventory

Preventing Electro-Static Discharge Damage

Problems caused by Electro-Static Discharge (ESD) may be very difficult to troubleshoot because damaged components may still operate somewhat rather than fail completely. We strongly recommend you take the following anti-static precautions (listed in order of importance) to avoid trouble:

- Leave ESD-sensitive parts in their anti-static packaging until you install them. The packaging may be a special plastic bag or the component's leads may be inserted in conductive foam. Parts which are especially ESD-sensitive are identified in the parts list and in the assembly procedures.
- Wear a conductive wrist strap with a series 1 megohm resistor. If you do not have a wrist strap, touch a ground briefly before touching any sensitive parts to discharge your body. Do this frequently while you are working. You can collect a destructive static charge on your body just sitting at the work bench. **DO NOT attach a ground directly to yourself as this poses a serious shock hazard.**
- Make sure your soldering iron is ESD-safe and has a grounded tip
- Use a grounded anti-static mat on your work bench.

Inventory

We recommend that you do a complete inventory, using the parts lists in Appendix A.



DO NOT HANDLE PARTS OR CIRCUIT BOARDS WITHOUT ANTI-STATIC PROTECTION (see *Preventing Electro-Static Discharge Damage* above). **Do not remove the black foam from the leads of any parts. This foam is further protection against static damage.**

Many components are inside small envelopes and bags. Open them one at a time, and return all of the parts to the envelope before opening another. Be careful to avoid mixing parts and putting them in the wrong bags or envelopes.

Identifying Common Resistors and RF Chokes

The color bands that indicate the value of each resistor are shown in the text to help you identify each part. However, it's helpful to familiarize yourself with the color code. The color-code chart (see Figure 2) shows how to read the four color bands on 5% resistors. For example, a 1,500 ohm (1.5 k) 5% resistor has color bands BROWN, GREEN, RED and GOLD.

1% resistors are similar, but use five bands: three significant digits, a multiplier instead of a gold or silver tolerance band, and a fifth and to indicate the tolerance. Since the bands usually fill the length of the resistor body, the fifth band is wider to indicate that the value should be read starting at the other end.

For example, the first four bands on a 1.50 k, 1% resistor are BROWN, GREEN, BLACK, BROWN. The multiplier value is 1 rather than 2 in this case because of the third significant digit.

If in doubt about a resistor's value, use a DMM. It may be difficult to see the colors on some resistors. Do not be concerned with minor deviations of your DMM reading from the expected value. Typical errors on most DMMs and the tolerances of the resistors normally produce readings that are slightly different from the value indicated by the color bands.

RF chokes and other small molded inductors look very much like short resistors. They have color bands that represent the same numeric values as resistors but because the inductors are short, it may not be obvious how to read them. In general the multiplier or tolerance bands are closer to the end than the first digit, just the opposite of the way a resistor. On small inductors the color bands may be centered on the body.

If you sort out the inductors before starting assembly, you will be able to positively identify each inductor from the color bands listed in the Parts List.

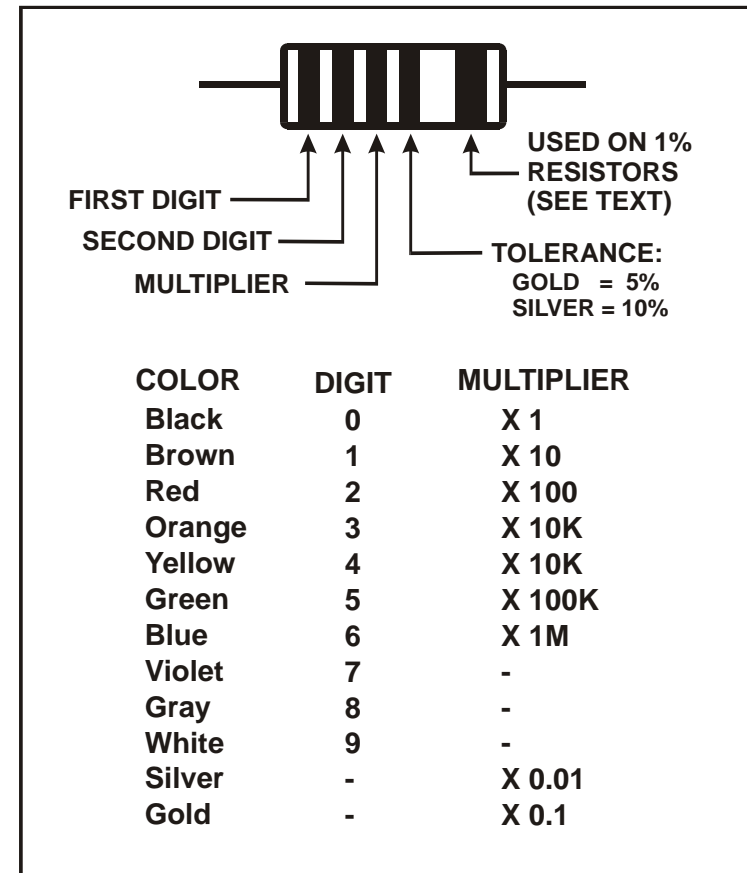

Figure 2. Resistor Color Codes.

Identifying Resistor Packs

Resistor packs combine a number of resistors in one component with multiple leads. They may be in-line packages with 6 or 10 leads in a row or they may be in 16-pin dual in-line pin (DIP) packages similar to many integrated circuits.

Like integrated circuits, pin 1 of each component is identified by a dot near it. Some resistor packs are symmetrical. That is, they can be installed either way. However, some are not. ALWAYS follow the instructions and orient the resistor pack exactly described in the procedure.

The value of the resistor pack is indicated in the last three digits shown on the package. The numbering scheme is similar to capacitors. The first two digits indicate the first and second most significant digits and the third digit is a multiplier. For example, "...391" indicates 390 ohms and "...104" indicates 100,000 ohms (100K).

Identifying Capacitors

Capacitors are identified by their value and the spacing of their leads.

Small-value fixed capacitors are usually marked with one, two, or three digits and no decimal point. If one or two digits are used, that is the value in picofarads (pF). If there are three digits, the third digit is a multiplier. For example, a capacitor marked "151" would be 150 pF (15 with a multiplier of 10^1). Similarly, "330" would be 33 pF, and "102" would be 1000 pF (or .001 μ F). Exceptions are described specifically in the text and parts list.

Fixed capacitors with values of 1000 pF or higher often use a decimal point in the value, such as .001, .047, or 2.2. This is the value in *microfarads* (μ F). (1 μ F is equal to 1,000,000 pF.)

The lead spacing is noted in the Parts Lists for most capacitors. If two different types of capacitors have the same lead spacing will indicate which one to use. When lead spacing is important, both the value and the lead spacing is shown in the assembly procedure. For example, "LS 0.1" means that the lead spacing is 0.1 inch (2.5 mm).

Identifying Toroid Cores

Several *toroidal inductors* are used in the KX1. It is important to use the correct type of core. This can be determined from the color and size. Two types of cores are used in the KX1: Iron powder cores and ferrite cores. If you mix them up, your KX1 will not operate properly.

The iron powder cores used are type T37-6. The *T* identifies an *iron-powder* core. The number following the *T* specifies the outside diameter in hundredths of an inch, in this case 0.37 inches (9.4 mm). The suffix (-6) refers to a specific mix of iron powder. You cannot tell what mix of iron power is used by looking at the core, so they are painted with specific colors. The -6 cores are painted yellow.

Ferrite cores are indicated in the parts list by the letters *FT* in the part number. The KX1 uses FT37-6 cores. Like the iron powder cores, the 37 refers to the outside diameter. The -46 identifies the type of ferrite used. These cores are not painted. They are dark grey.

Tools

You will need the following tools to build this kit:

- Fine-tip temperature-controlled ESD-safe soldering station with 700 to 800°F tip (370-430°C). Recommend a spade tip approx. 0.05" (1.3 mm) wide. Do not use a high-wattage iron or soldering gun since this can damage pads, traces, or the parts themselves.
- IC-grade, small-diameter (.031") solder (Kester #44 or equivalent).



DO NOT use acid-core solder, water-soluble flux solder, additional flux or solvents of any kind. Use of any of these will void your warranty.

- Desoldering tools and supplies are invaluable if you make any modifications or need to do any repairs. Narrow solder wick or a good vacuum desoldering tool such as the Soldapullt® model DS017LS are recommended. See *Soldering and Desoldering*, on page 11 for more information.
- Screwdrivers: A small #2 Phillips, a small flat-blade for slotted screws and a very small flat-blade (about 0.1 in or 2.5 mm wide) with an insulated handle to adjust the trimmer caps.
- Needle-nose pliers.
- Small-point diagonal cutters. Flush-cutting type is required (Xcelite MS54-5J or equivalent).
- Digital Multimeter (DMM) for voltage checks and confirming resistor values. A DMM with capacitance measurement capability is desirable, but not required.
- 50-ohm dummy load capable of handling 5 watts, minimum.
- Magnifying glass or visor.

We strongly recommend that you use a conductive wrist strap and anti-static mat during assembly. These items are available at very low cost from Jameco, Mouser, and other electronics suppliers.

Refer to www.elecraft.com for tool sources and solder recommendations.

Soldering and Desoldering



Use adequate ventilation when soldering; avoid inhaling smoke or fumes. Always wash your hands after handling solder, as lead residue is highly toxic.

Solder Recommendations

We recommend small-diameter (.02 to .03") rosin-core solder, similar to Kester type 44. Solder with 2% silver is used by some builders and will work equally well.

If you use a minimum of solder, there will be no need to clean PC boards. The use of acid-core solder, water-soluble flux solder, or any corrosive or conductive flux or solvent is likely to damage components and/or PC boards.

Soldering

When applying solder, use the *minimum* amount required to surround the component lead and make good contact with its printed-circuit pad. You don't need a "fillet" (build-up) of solder.

To provide a good connection, the solder must flow onto both the component lead and its PC board pad. To ensure that both will be heated at the same time, the tip of the iron should contact both the component lead and the PC board pad before solder is applied.

Solder joints should be *clean* and *shiny*. If a joint appears dull or has fine cracks, it is probably **cold**. Cold solder joints should be cleaned and re-soldered. First, use solder wick (desoldering braid) to remove the old solder. Then apply fresh solder. If you have many cold solder joints, it probably indicates that your soldering iron temperature is too low, or that the tip or solder itself is defective.

New soldering iron tips must be **tinned** before they're used. Allow the iron to warm up completely, then apply solder and allow it to coat the entire tip. After a few minutes, wipe off the excess solder. Use a sponge for wiping the iron tip, and clean the sponge often.

Desoldering

The printed circuit boards used in the kit are *double-sided*, meaning that they have circuitry on both sides. The component mounting holes are *plated-through* to complete electrical connections between the two sides.

Removing components from double-sided boards can be difficult, since you must get all of the solder back out of the hole before a lead can be removed. To do this, you'll need *solder wick* (desoldering braid) and/or a vacuum desoldering tool. It also takes some practice. A number of suggestions are provided below.

The best strategy for avoiding de-soldering is to place all components properly the first time. Double-check values and orientations, and avoid damaging parts via ESD.

When removing components:

- Don't pull a lead or pin out of a hole unless the solder has been removed, or you are applying heat. Otherwise, you can literally pull out the plating on the plated-through hole.
- Limit soldering iron contact to a few seconds at a time.
- Use small-size solder-wick, about 0.1" or 2.5 mm wide. Use the wick on both the top *and* bottom pads when possible. This helps get all of the solder out of the hole.
- If you use a vacuum desoldering tool (solder sucker), use a *large* unit. Small solder suckers are not very effective.
- The safest way to remove ICs and other components with more than 3 leads is to *clip all of the pins* at the body of the device first, then remove all of the pins *individually*. You may damage pads and traces by trying to remove such components intact.
- Invest in a PC board vice with a heavy base if possible. This makes parts removal easier because it frees up both hands.

If in doubt about a particular repair, ask for advice from Elecraft or from someone else with PCB repair experience.

Assembly Notes

Each step in the assembly process is accompanied by a check-box:



As you may have noticed already, the symbol below is used to alert you to important information:



Do not skip any steps. You may adversely affect both the performance and appearance of the kit by using the wrong assembly order.

Installing Parts

Follow the instructions carefully about the position of parts. Many parts must be positioned exactly as instructed or they may strike the case or other components when the KX1 is assembled.

The value and corresponding color codes are shown for all resistors and inductors that may have them. In some cases the value may be stamped on the component instead of the color code.

Before beginning assembly, you should review the photographs in Appendix D to see what the completed PC boards look like. You'll also find front and back views of each PC board in the Parts Placement Drawings, Appendix F.

IC Sockets

Only one integrated circuit is mounted in a socket. Do not use a different type of socket. The one supplied is a low-profile socket that provides just enough room for the case to fit together.

Do not use sockets on any ICs other than the one provided. Mount the other ICs directly on the board as instructed. Sockets will not allow the cover to close. Also sockets in RF may cause improper circuit operation due to increased lead inductance and capacitance.

Assembly - Part I

In Part I, the control, display, and audio stages will be assembled and tested. Later sections cover receiver (Part II) and transmitter (Part III) assembly and test.



BEFORE YOU START:

1. **WEAR A GROUNDED WRIST STRAP** or ground yourself briefly before touching components. You can discharge static by frequently touching an unpainted, grounded metal surface.
2. **WEAR EYE PROTECTION** before trimming any leads.
3. **WASH YOUR HANDS** after handling solder. Solder is a toxic substance.
4. **PROVIDE VENTILATION** and avoid inhaling the fumes produced by soldering.



If you haven't done so already, open the bag of components labeled **KX1 MAIN BAG** and sort the parts into groups. Many of the components will be in small paper envelopes. **Do not** mingle the contents of one envelope with another. As you are instructed to locate particular components, use the photographs in the KX1 PCB parts list in Appendix A to help identify them.



The components pre-installed on the circuit board are extremely static-sensitive. Wear a wrist strap or ground yourself before handling the board.



Position the circuit board on your bench so that KX1 is visible in the upper left corner. This is the side of the board that will be directly under the front panel when the transceiver is completed. This side will be referred to as the top face of the board throughout the assembly procedure. Components will be installed on both sides of the board.



Turn the circuit board over so the bottom is facing up and orient it so the outline for J1 is in the upper right corner. Find the outline for resistor R8 next to the outline for J1.

Bend the leads of resistor R8, 6.8k (blu-gry-red), 1/4 watt, at right angles close to the body. Insert the leads in the solder pad holes, and bend them out on a 45-degree angle on the opposite side of the board to hold the resistor in place.



Components MUST be tight against the board or the case may not close properly during final assembly. This is especially true of components on the bottom of the board where there is very little clearance between the board and the battery packs.

Check the position of the resistor to ensure it is centered in the printed outline and flush against the board as shown in Figure 3. Solder and trim the leads.

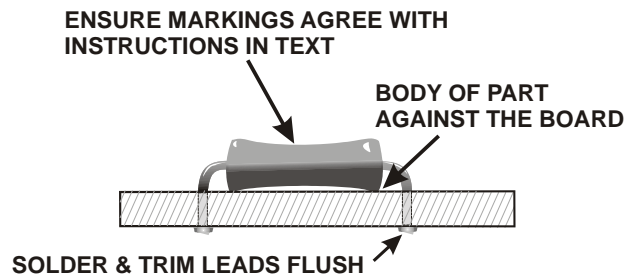

Figure 3. Installing Fixed Resistors.

Locate the printed outline for R28 on the back of the board. It is about 3/4" (2 cm) down from the top edge near the center.

Bend the leads of resistor R28, 1.8k (brn-gry-red), 1/4 watt, to fit in the holes indicated on the board. Note that the leads should NOT be bent close to the body of the resistor like you did for R8. Fit the leads so the body of the resistor sits against the board within the outline, then bend them outward at about a 45 degree angle to hold the resistor in place.

Solder the leads to R28 and trim them flush with the board.



From this point forward, instructions to “install” a component mean to position it within its outline against the board, solder, and trim the leads flush on the opposite side.

Locate the two 200 ohm (red-blk-brn) 1/8 watt fixed resistors, R6 and R7. They are about half the size of the 1/4 watt resistors you just installed.

Install the 1/8 watt resistors in the spaces shown just to the left of R8 near the top of the board:

– R6, 200 ohms (red-blk-brn), 1/8 watt.

– R7, 200 ohms (red-blk-brn), 1/8 watt.



Components may be soldered one at a time or in groups. Leads can be trimmed either before or after soldering.

⚠ Save the longer clipped component leads. Several of them will be needed for grounding wires and a jumper.

☐ Install the following 1/4 watt resistors on the bottom side of the board. Their locations are in the lower right quadrant of the board when it is oriented so outline for J1 is in the upper right corner.

- _ R16, 1k (brn-blk-red).
- _ R17, 1k (brn-blk-red).
- _ R22, 300 ohms (org-blk-brn).
- _ R23, 470 ohms (yel-vio-brn).

☐ Turn the board over (top face up) and orient it so that the KX1 lettering is in the upper left corner and the notch is on the lower edge.

☐ Install the following 1/4 watt resistors about 3/4" (2 cm) to the left of the notch and about 3/4" (2 cm) up from the lower edge of the board:

- _ R12, 6.8k (blu-gry-red).
- _ R13, 22k (red-red-org).

☐ Locate resistor pack RP5, 100 k ohm (104). RP5 is a ten-pin in-line package whose number on the side ends in "104" (see Figure 4). If you are in doubt about the value, use your DMM to verify that the resistance between adjacent pins is 100k ohms. Note the dot at one end indicating pin 1.

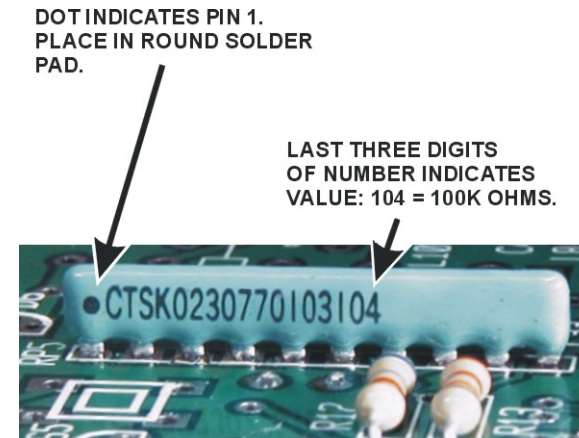



Figure 4. Installing Resistor Packs.

☐ Find the outline for RP5 on the top of the circuit board. With the board face up so that KX1 is in the upper left corner, the outline for RP5 is just to the left and above the notch at the center of the lower edge of the board.

Insert RP5 with Pin 1 of the pack in the round solder pad. The round pad is farthest from the edge of the board.

 **Be careful to orient the resistor packs so the dot next to Pin 1 on the pack is at the round solder pad on the board. Once soldered in place, it is almost impossible to remove the pack without destroying it.**

Wet your soldering iron with a small amount of solder, and touch it to one of the pins to tack-solder it in place.

Check the position of RP5 to verify that the pins at both ends are inserted as far as they will go into the board as shown in Figure 4, then solder and trim all ten leads.

Follow the same procedure to install six-pin resistor pack RP2, 1K (102) above and to the left of RP5. Pin 1 goes at the top pointing toward the printed outline for C51.

Install ten-pin resistor pack RP4, 10k (103) below U2 in the top left quadrant of the board. Pin 1 goes to the left, pointing toward the outline for RP3.

Install ten-pin resistor pack RP3, 10k (103) to the left of RP4. Pin 1 of RP3 is at the top, nearest the end of RP4.

Locate resistor pack RP1, 390 ohms (391). RP1 is in a 16-pin DIP package that looks much like an integrated circuit. The resistance elements run across the package (e.g. pin 1 connects to 9 through 390 ohms).

Test fit RP1 between RP2 and RP3 and just below the outline for DS1 on the circuit board. It is normal for the pins of a DIP package to be slightly flared so they do not easily fit into the solder pad holes. If necessary, place RP1 so that an entire row of pins is against a smooth surface and straighten the pins as shown in Figure 5.

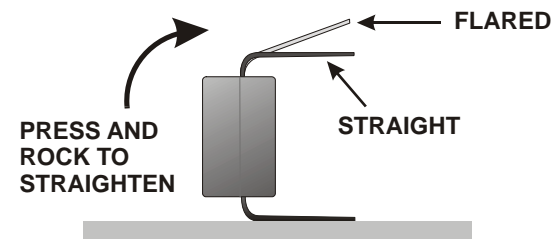

Figure 5. Straightening IC Pins.

Place RP1 on the circuit board with pin 1, indicated by a dot on top of RP1, in the round solder pad. Be sure it is seated all the way so the shoulders on the pins are against the board. Solder and trim all 16 pins.

Turn the board face up so KX1 is in the upper left corner. Locate the printed outlines for diodes D2 and D3 near the center of the left edge of the board.

Locate diodes D2 and D3 (1N5817). Note that there is a band on one end of the diode body.

 **All diodes MUST be installed with the banded end of the diode over the band on the circuit board.**

Install the following diodes:

– D2 (1N5817)

– D3 (1N5817)

With the board face up (KX1 in the upper left corner) position the 28-pin socket in the space provided for U1 in the lower left quadrant of the board. The outline has (SOCKET) inside of it.

 **DO NOT TRIM the 28-pin socket pins before or after soldering. These pins are hollow and form the lower part of the socket for the IC pins.**

 **Do not substitute a different socket for the one provided. The very low profile of the supplied socket is required for the case to fit together during final assembly.**

Orient the socket so the notch at one end is toward the left edge of the board, aligned with the notch in the printed outline.

Hold the socket against the circuit board and tack-solder pins at opposite corners of the socket.

 **Do not overheat the socket pins. Too much heat will melt the plastic socket. Use only enough solder to make a good joint.**

Check to ensure that the socket is pressed against the circuit board at both ends. If necessary, reheat the pins at each end and press down on the socket so it rests directly against the board.

Solder all 28 pins. Double-check your work and inspect each pin. Use a magnifier if necessary. If a pin is missed or poorly soldered, it may make contact during initial testing, but become intermittent later. Such intermittents can be very difficult to troubleshoot. **Remember; do not trim the socket pins!**

- Turn the board face down so the printed outline for power connector jack J1 is in the upper right corner.
- Locate the printed outline for C39 to the left of the outline for J1 on the board.
- Test fit a .1 μ F (104) capacitor in the solder pad holes for C39. Position the capacitor so that about 1/16" (1 mm) of lead shows above the surface of the board. If necessary, gently straighten the leads using long nosed pliers. **Do not tug on the leads. Squeeze and bend them with your pliers as needed.**
- Solder and trim the C39's leads.
- Bend C39 down against the board as shown in Figure 6.



Figure 6. Positioning C39 Against the PCB.

- Locate the outline for capacitor C31 along the top edge of the board just to the left of the outline for J1.

- Test fit a .1 μ F (104) capacitor in the solder pad holes for C31. Use a ruler to verify that the top of the capacitor is no more than 5/16" (7.9 mm) above the board. Normally these capacitors will be well below that height limit but, if necessary, gently straighten the leads using long nosed pliers so it will sit closer to the board and meet the height requirement. **While forming the leads, do not tug on them. Squeeze and bend the leads with your pliers to straighten them.** Slight chipping of the epoxy around the leads will not harm the capacitor.

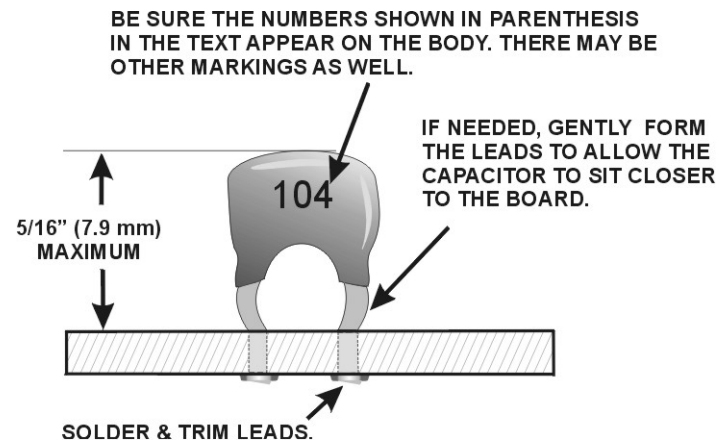

Figure 7. Installing Fixed Capacitors.

- Solder and trim the leads on capacitor C31.

Following the same procedure, install capacitor C30, .01 μF (103) next to C31.

Turn the board top face up so that KX1 is in the upper left corner. In the following steps you will install several capacitors on the top of side of the board. Be sure that the top of no capacitor is more than 5/16" (7.9 mm) above the board. Be especially careful of the larger electrolytic capacitors (see Figure 8). Use a ruler as needed to check the height.

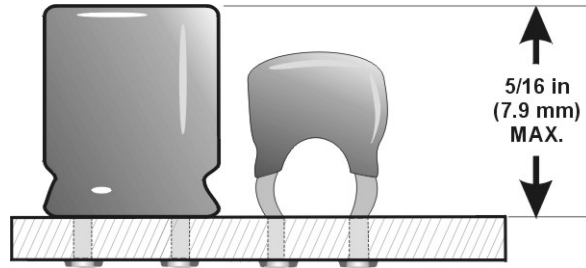

Figure 8. Maximum Height of Capacitors on Top of Board.

Install capacitor C6, .01 μF (103) directly above diode D3 on the left edge of the board.

Install capacitor C37, .01 μF (103) between D2 and resistor pack RP3.

Install capacitor C12, .1 μF (104) between D2 and the socket for U1.

Install capacitor C5, .1 μF (104) below the socket for U1 near the bottom edge of the board.

Install the following capacitors between the socket for U1 and the bottom edge of the board:

- _ C25, 27 pF (270)
- _ C24, 27 pF (270)

Install the following capacitors to the right of resistor pack RP5:

- _ C32, .01 μF (103)
- _ C33, .01 μF (103)

Install capacitor C55, .01 μF (103) on the bottom edge of the board about 1-1/4" (2 cm) to the right of resistor pack RP5.

Locate electrolytic capacitor C38 (10 μF , 35 v) and inspect the leads. One lead should be shorter than the other. The capacitor body will have a stripe and a minus sign (—) above the shorter lead.

Locate the printed outline for C38 to the left of RP3 on the top face of the circuit board. Note that there are two solder pads for the capacitor leads: one is round and one is square. A plus (+) symbol is printed next to the square pad.

Insert electrolytic capacitor C38 (10 μ F, 35 v) with the longer lead passing through the square solder pad with the (+) symbol next to it and the shorter lead through the round pad. Bend the leads to hold the capacitor in place against the board.

Be sure that the capacitor is tight against the board and solder the leads. Use a ruler to verify that the top of the capacitor is no more than 5/16" (7.9 mm) above the board (see Figure 8). After soldering, trim the leads flush with the bottom of the board.



All electrolytic capacitors MUST be installed with their leads oriented to observe the polarity markings as described above.

Install electrolytic capacitor C10 (10 μ F, 35 v) below resistor R13 at the bottom edge of the board. **Observe the proper polarity as you did for C38 above, and be sure the capacitor is no higher than 5/16" (7.9 mm) above the board.**

Turn the board over so the bottom face is up and the outline for J1 is in the upper right corner.

Install electrolytic capacitor C7 (220 μ F, 25 v) at the center of the board near resistor R28. **Be sure to observe the proper polarity as you did above.** Save one of the clipped leads to use in the following steps.

Turn the board over so the top face is up and test-fit the low-profile crystal in the space provided for X1 near the bottom edge below the socket for U1. The crystal may be installed either way. Note: The holes in the solder pads for X1 may be larger than necessary to fit the leads. This is normal. It is to accommodate different styles of leads on the crystals supplied with some kits.



Do NOT use more solder than necessary on the leads for X1. Too much solder will wick through the holes and may cause a short to the case of X1 underneath the crystal. The short is impossible to see or correct without removing the crystal.

Spread X1's leads as necessary to hold the crystal against the board and solder one lead. **Do not hold your iron on the lead more than 2 or 3 seconds, maximum. Too much heat will ruin the crystal.**

Check to ensure that X1 is sitting directly against the board. If necessary, reheat the soldered lead while pressing down on the crystal.

Solder the second lead to X1 and trim the leads flush.

Use a discarded component lead to ground the case of the crystal as follows:

- Solder one end of the lead in the ground hole near the edge of the board to on the left side of the crystal.
- Tin the top of the crystal nearest the lead with a small amount of solder. Keep the soldering time to 3 seconds or less to avoid overheating the crystal. Allow the crystal to cool if you need to apply heat more than once. It often helps to tin the case more quickly if you lightly scrape the metal with a knife or a screwdriver blade first.
- Bend the ground lead so it lies flat against the top of the crystal where it is tinned and solder it to the top of the metal case.

Install white LED D1 as follows:

- Locate the flat side on D1's flange.
- Position D1 over the outline in the lower left corner of the board with the flat side of the flange toward the corner of the board.
- Bend the leads so that when they are inserted through the solder pads, D1 rests against the board as shown in **Figure 9**. Note: This LED is provided to illuminate your note pad or log while operating in the dark. The slight downward angle will help direct the light down onto the table top.
- Check to ensure that the flat side of the flange is toward the corner of the board. D1 will not work if it is installed backwards.
- Solder and trim both leads.

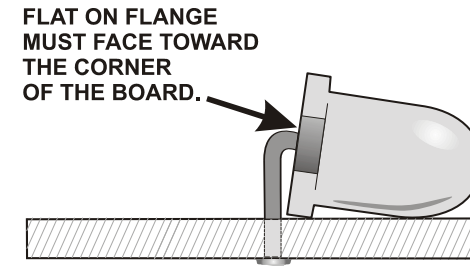

Figure 9. Installing LED D1.

- Turn the bottom face up with the outline for J1 in the upper right corner.
- Position J1 (DC power connector) on the board so the three tabs on the bottom of the jack fit through the slotted solder pads.
- Solder one of the tabs and then check the position of the jack. It must be centered within the printed outline on the board with the connector opening parallel with the edge of the board. Be sure the jack is resting directly against the board. There must be no gap between jack and the board. If necessary, reheat the soldered tab and adjust the position of the jack.
- When you are satisfied with the position of the jack, solder the remaining two tabs, then recheck the first tab be sure it is properly soldered.

Test-fit two-pin plug P1 directly below J1. Orient P1 so the locking ramp that sticks up alongside the pins is on the side farthest from J1 as shown on the printed outline on the board.

Place the shell for the mating jack over the pins of P1 to protect your fingers and, while holding P1 directly against the board, solder one of P1's pins. Check the following. If necessary, reheat the soldered pin and adjust P1.

- _ P1 is oriented so the locking ramp is on the side farthest from J1.
- _ P1 is sitting vertically and resting flat against the board.

Solder the second pin of P1 to the board, then touch up the tack-soldered connection as needed to form a good joint.



If J3 is not aligned correctly as described in the next step, the front cover will not fit during final assembly.

Install J3 at the center of the bottom edge of the board using the same procedure to ensure it is square, inside the silk-screened outline and flat against the board. **Be certain you mount the jack on the BOTTOM face of the board within the printed outline.**

Turn the board over so the top face is up with KX1 in the upper left corner.



Do not install caps on pushbutton switches S3, S4, and S5 until instructed to do so later in the assembly process. It is very easy to damage the caps while soldering adjacent parts.

Position switch S5 on the board between RP2 and RP5. It may be oriented either way that places the four pins in the solder pad holes. With all four pins in the solder pad holes, press down on S5 until the plastic bumps on the bottom of the switch body are touching the board. Use a magnifier if necessary to be certain that the bumps on the bottom of the switch are against the board. Each of the four pins should stick out through the solder pads on the bottom of the board about 3/32" (2.4 mm).

When you are satisfied that the switch is firmly against the board, solder and trim all four terminals.

Install pushbutton switches S4 and S3 next to S5 using the same procedure.

- Test fit slide switch S2 along the edge of the board next to electrolytic capacitor C10. The switch can be oriented either way around. Note that it rests on shoulders on the three terminals that determine its height above the board.
- Hold S2 vertical and against the shoulders on the tabs with your finger on the slide, and tack-solder the center pin to hold it in place.
- Inspect the switch to be sure it is perfectly vertical and not tipped to either side. If necessary, reheat the pin and adjust the switch's position.
- When you are satisfied that the switch is perfectly straight, solder the two end pins. Resolder the center pin last as needed to create a good joint.
- Use the same procedure to install slide switch S1 to the left of crystal X1. S1 also may be mounted oriented either way.

 **Voltage regulators U8 and U9 are installed in the following steps. These devices look very similar. Double check the markings on each device to be sure you have the correct one before soldering it in place.**

- Install U8 (78L05) next to pushbutton switch S5 as follows:
 - _ Align the flat side of the device as shown by the printed outline (see Figure 10).
 - _ Insert the device into the solder pad holes until the top of the device is less than 5/16" (7.9 mm) above the board. Use a ruler to confirm the height. If necessary, remove the device and form the center lead to allow it to sit close enough to the board.
 - _ Solder and trim all three leads.

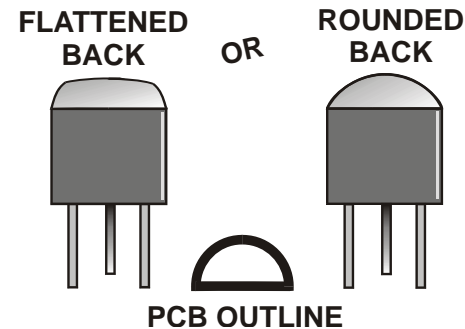

Figure 10. Transistor Orientation Guide.

Install U9 (77L06) below RP5 on the lower edge of the board using the same procedure that you used for U8 above. Be sure the top of the device is no more than 5/16" (7.9 mm) above the board.

Install transistor Q7 (2N4124). The position for Q7 is in the upper right quadrant of the board, about 1" (2.5 cm) down from the top edge and 1-3/4" (4.4 cm) from the right hand edge. Be certain the top of the transistor is no more than 5/16" (7.9 mm) above the board.

Install 8-pin integrated circuit U3 (4427) in the space provided near the right hand edge of the board, about 1-1/4" (3.3 cm) down from the top edge as follows:

- Test-fit U3 to see if the pins line up with the holes in the solder pads on the board. If needed, straighten the pins like you did for resistor pack RP5 (see Figure 5).
- Identify the end of U3 where pin 1 is located. It will have a notch, a dimple, or both at this end (see Figure 11).
- Insert U3 into the solder pad holes with the notched, pin 1 end lined up with the notch on the printed outline.
- Spread out the pins on the opposite corners to hold U3 in place, then solder and trim all 8 pins.

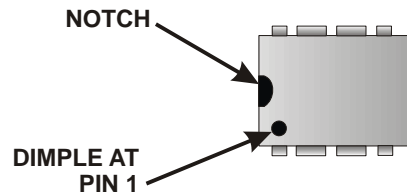

Figure 11. IC Alignment.

Install 3-digit LED display DS1 as follows:

- Insert the 3-digit LED display in the space bounded by resistor packs RP1, RP2, RP3 and RP4. The pins on DS1 allow it to be inserted only one way.
- Hold the display against the board and tack-solder pins at the opposite corners.
- Inspect the display carefully to ensure that it is firmly against the board at both ends. If necessary, reheat one of the pins and adjust the display. It is very important that the display be fully seated and resting directly against the board at both ends.
- Solder and trim all 13 pins on the display.

Install encoder Z1 as follows. Z1 mounts to the left of transistor Q7.

- Test fit Z1 on the board. It will only go one way. The side with three terminals is nearest the top of the board.
- Press down on Z1 until the small nubs at each corner rest directly against the board. It is very important that Z1 be fully seated against the board.
- Solder two pins on opposite corners of the encoder, then recheck to ensure it is sitting against the board. If necessary, reheat the solder and press down on the encoder to position it.
- Solder the two large tabs to the plated ring around the edge of the mounting holes. Apply only enough solder to make a good mechanical and electrical connection between the tab and circuit board. **Do NOT try to fill the holes with solder.**
- Solder and trim all five pins.

Visual Inspection

- Verify correct orientation (banded end) of diodes D2 and D3, using the parts placement drawing (Appendix F).
- Verify the correct orientation of each electrolytic capacitor. The side of the capacitor with the strip and minus (-) sign must face away from the + sign printed on the board.
- Examine both sides of the PC board closely for solder bridges, cold solder joints, or unsoldered components.

Resistance Checks

- Make the resistance checks listed below with your DMM's negative (-) lead connected to the circuit board ground at the screw hole just above capacitor C6.

Test Point (+)	Resistance
U1 Pins 1, 3, 4, and 20	> 1 k
U1 pins 8 and 19	< 5 ohms
U1 all other pins	> 10 k
U3 pin 3	< 5 ohms
U3 all other pins	> 10 k
D2 or D3 cathode (banded end), S1 On	> 1 k
D2 or D3 cathode, S1 Off	> 10 k

Alignment and Test - Part I

In this section you'll become familiar with basic KX1 operation, while testing the control and display functions.



Microcontroller U1 is extremely static-sensitive. Wear a wrist strap or ground yourself before handling U1.

Remove microcontroller U1 from its conductive foam packing and inspect the pins. The two rows of pins must be straight and parallel to each other to establish the proper pin spacing for insertion into the socket. If necessary, straighten the pins as shown in Figure 5.

Identify the end of the IC where Pin 1 is located. It will have a notch, a dimple or both at this end (see Figure 11).



When U1 is pressed into its socket, you must be careful to avoid jamming its pins. Make sure all the pins are lined up with the associated holes before pressing down on the IC. Watch the pins on both rows as you press down to be sure each pin goes straight down into its socket hole and does not bend in under the IC or outward alongside the socket. Realign each pin individually with its socket hole, if necessary.

Insert microcontroller U1 in its socket with pin 1 or the notched end lined up with the notched end of the socket (the end closest to the edge of the board).

Press down very firmly on U1. If it is not seated as far as possible into its socket, the pins may not make good contact.

Temporarily mount the VFO knob on the shaft of encoder Z1. Align the set screw with the flat side of the encoder shaft and tighten it using the Allen wrench supplied.



You may notice some side play in the encoder shaft. This is normal in miniature shaft encoders with an integral pushbutton switch.

Set slide switches S1 and S2 to the OFF position.

Connect an 8 to 14 VDC power supply to J1 with the positive (+) lead to the center pin. A mating connector for J1 is supplied with the kit. If you use a power supply voltage of less than about 10.5 volts, you may see a **BAT LO** message flashed on the LED during initial tests. This is because the **BAT** menu parameter is set to **10.0** volts by default. You can set the **BAT** parameter to a lower value to eliminate the warning message.

Unwrap the cover and set it near the circuit board so you can see the legends identifying the switches and their functions.



If any test or alignment step fails, refer to the Troubleshooting section (Appendix E).

LED Tests



When testing the lamp in the following step, do NOT look directly at the white LED. It is very bright.

- Switch S1 (LAMP) On and verify that D1 lights, then turn it Off.
- Switch S2 (POWER) On. **If you see or smell smoke, or a component feels hot to the touch, switch S2 Off and disconnect the power source immediately.** Locate the source of trouble before proceeding.
- You should now see either **E10** or **00.0** on the 3-digit LED display. **E10** is an informational code that indicates that the EEPROM (configuration memory) on the microcontroller has been initialized to default values. This message will appear only once, and can be cleared by tapping any of the three pushbutton switches. **00.0** is a portion of the VFO frequency, which is set to 7100.00 kHz the first time you turn power on. The display format will be described in a later step.



After a few seconds, the display turns off automatically if you haven't touched the VFO knob or pressed any switches. This is intended to extend battery life. Moving the VFO knob or operating one of the pushbutton switches will turn it on again. (The display time-out is programmable. This will be discussed in the next section.)

Voltage Checks

- Connect your DMM's (-) probe to circuit board ground at the screw hole next to capacitor C6. Use the (+) probe to check the following DC voltages:
 - U1, pin 1: 5 ± 0.25 Vdc
 - U3 pin 6: 6 ± 0.25 Vdc
 - D2 anode: Supply voltage.
 - D2 cathode (banded end): supply voltage – 0.3 Vdc (approx).
- Leave your DMM's (-) probe connected to the circuit board ground, and set your DMM for a 200 to 300 millivolt AC range. Check the AC voltage at the following pins. A higher voltage than shown may indicate a problem with one of the voltage regulators as explained in the note below.
 - D2 anode: < 20 mV AC rms.
 - D2 cathode (banded end): <20 mV AC rms.
 - U1 pin 1: <20 mV AC rms.
 - U3 pin 6: <20 mV AC rms.



The 2.7 V and 6 V regulators used in the KX1 (U7 and U9, respectively) are *low-dropout* types, which may oscillate if their bypass capacitors are defective or are of the wrong value. If you see high AC voltage at any of the points indicated above, verify that electrolytic capacitors C7, C10, and C38 are installed in the correct orientation and that their leads are properly soldered. If they are, you may be seeing a false AC voltage indication due to noise or probe leakage; re-test using a different DMM.

The Tap/Hold Rule

Each of the push-button switches on the front panel has two functions, one activated by a TAP (short press) and the other activated by a HOLD (long press, about 1/2 second). The upper label on each switch shows the TAP function (white lettering), and the lower label shows the HOLD function (yellow lettering). To highlight this in the text, we use two different typographical styles to identify switches: **TAP** and **HOLD**.

Accessing the Configuration Menu

- Tap **MENU** to enter the KX1's configuration menu. You should see **LED** on the display, which is the first menu entry (display brightness setting and timeout period). Try rotating the VFO knob, which scrolls through all 16 menu entries.
- Use the knob to return to the **LED** menu entry. Then hold **EDIT** to change the LED parameter. The display will change to **L** followed by a number from **0** to **6**.
- Tap **BAND** and **RIT** to change the display brightness. Settings of **2** or **3** are about right for indoor daytime use, **0** and **1** are suitable in low lighting, and **5** or **6** in bright lighting.²
- Rotate the VFO knob to select the desired LED timeout (**5** to **60** seconds or **INF** for infinite, i.e. never times out. As you rotate the knob, the timeout period is flashed, e.g. **t10** for 10 seconds. (Note: When the LED times out, it will go blank. However, in very low lighting or darkness, you may see a slight residual illumination.)
- Tap **MENU** once to return to menu scroll mode, then tap it again to return to the frequency display.

² CW feedback on switch-press can be used in lieu of the display. This is described in the Operation section.

Frequency Display and Band Change

The display shows three digits of the operating frequency. Which three digits are shown depends on which tuning rate you've selected: 1 kHz, 100 Hz (default), or 10 Hz. At 7100.00 kHz, the three tuning rates produce the following displays:

7100.00 **7100.00** **7100.00**

- To select 1 kHz steps, press and hold the VFO knob (from now on, we'll indicate this as: hold **1 kHz**). Then try rotating the knob. No decimal point is displayed at this step size.
 - To select 10 Hz or 100 Hz steps, tap the VFO knob (i.e., tap **10/100 Hz**). The tuning rate alternates between 10 and 100 Hz steps as you tap, and the decimal point moves accordingly.
 - You can check the MHz and kHz digits at any time by tapping **BAND**. For example, if the VFO frequency is 7100.00 kHz, tapping **BAND** will first show **7**, then **100**, then return to the appropriate display for your selected tuning rate.
 - To change bands, tap **BAND** *twice*, quickly. This will trigger the MHz-kHz display, in this case showing **14** then **100** (14100.00 kHz). (Tapping or double-tapping **BAND** also stores the present frequency for the next power-up or band change.)
 - Set the POWER switch to OFF.
 - Disconnect the power source from J1.
 - Remove the VFO knob and set it aside for reinstallation later.
 - Wrap the cover and put it in a safe place until it is needed.
-  **Leave microcontroller U1 in its socket during the remainder of the assembly process. Be sure to observe ESD handling precautions at all times.**

Assembly – Part II

In this section you will assemble and test the receiver circuits. The transmitter circuits will be assembled in Part III.

Position the board face up with KX1 in the upper left corner.

Install R19, 1.8k (brn-gry-red), 1/4 watt to the right of RP5 near the center of the board.

Turn the board over so that J1 is in the upper right corner. Install the following 1/4 watt resistors in the lower left quadrant of the board. Form the leads as required so the resistors lie directly against the board within the printed outlines.

- _ R21, 2.7k (red-vio-red)
- _ R14, 47 ohms (yel-vio-blk)
- _ R18, 3.3 megohm (org-org-grn)
- _ R29, 22k (red-red-org)
- _ R5, 4.7k (yel-vio-red)
- _ R20, 1k (brn-blk-red)
- _ R15, 1 megohm (brn-blk-grn)
- _ R25, 10 ohm (brn-blk-blk)

Open the envelope containing the seven molded inductors and sort them to be certain you know which is which before you install the first one. Compare the color codes you find on each inductor with the list below. The color bands are very small. Use a magnifier as needed to be sure of the colors.

- L4: Micro (smaller) size, 2.2 μ H (red-red-gold)
- L5: Mini (larger) size, 5.6 μ H (grn-blu-gold)
- L6: Mini size, 6.8 μ H (blu-gry-gold)
- L7: Mini size, 4.7 μ H (yel-vio-gold)
- L10: Micro size, 33 μ H (org-org-blk)
- L8: Micro size, 18 μ H (brn-gry-blk)
- L9: Micro size, 100 μ H (brn-blk-brn)



Do not pull on the inductor leads while handling them. They are more easily damaged than the resistors or capacitors.

Turn the board so the bottom face is up with jack J1 in the upper right corner.

Install the following inductors below R6 and R7 in the upper right quadrant.

- L4, micro (smaller) size, 2.2 μ H (red-red-gold)
- L5, mini size, 5.6 μ H (grn-blu-gold). L5 may be larger than the outline. Bend the leads to fit into the pads with the body of L5 pressed to one side against the board. Do not space L5 above the board or it may strike other components when the K3 is assembled.

Turn the board face up with KX1 in the upper left corner.

Install the following inductors to the left of U3 on the right side of the board.

- L7, mini (larger) size, 4.7 μ H (yel-vio-gold)
- L6, mini (larger) size, 6.8 μ H (blu-gry-gold). If you have the KXB3080 module to install, mount L6 on the bottom of the PC board as shown in the KXB3080 module instructions. If the lead spacing on L6 is larger than the hole spacing in the board, bend the leads back under L6 to fit in the holes.

Install the following inductors below R19 near the center of the board.

- L10, micro size, 33 μ H (org-org-blk). L10 may be larger than the outline. Bend the leads to fit into the pads with the body of L10 pressed to one side against the board. Do not space L10 above the board or it may strike other components when the KX1 is assembled.
- L8, micro size, 18 μ H (brn-gry-blk)
- L9, micro size, 100 μ H (brn-blk-brn)



In the next step you will install a diode which must be oriented in the proper direction. Be certain to align the banded end of the diode over the band on the circuit board.

Install diode D4 (1N4148) on the lower edge of the board to the right of L9.

Install varactor D5 (1SV149) as follows. When you are finished the top of the varactor must no be more than 5/16" (7.9 mm) above the board.

- Locate the outline for D5 on the board. It is near the center of the board immediately to the right of resistor pack RP5.
- Orient the varactor according to the printed outline on the board. The varactor may have a beveled back instead of a rounded back as shown on the board (See Figure 10).
- Insert the varactor leads in the solder pad holes. The varactor has a third lead that has been clipped close to the body. Space the varactor up off of the board slightly to ensure this lead does not short to the board.
- Solder one lead, then check to ensure that the top of the varactor is no more than 5/16" (7.9 mm) above the board. If necessary, reheat the joint while adjusting the height of the varactor.
- Solder the second lead and trim both leads.

Follow the same procedure to install varactor D6 (1SV149). D6 is located above D5.

 In the following steps you may be installing some capacitors with leads closer together than the hole spacing in the circuit board. Form the leads of these capacitors as shown in Figure 12. Be sure the top of the capacitor is no higher than 5/16" (7.9 mm) above the board (see Figure 7).



Figure 12. Forming Capacitor Leads.

- Install the following capacitors above and to the right of the 3-digit LED display.
 - _ C50, 39 pF (39 or 390), lead spacing (LS) 0.2"
 - _ C51, 100 pF (101), LS 0.2"
 - _ C52, 22 pF (220)
- Install capacitor C16, .1 μ F (104) between varactors D5 and D6.
- Install capacitor C4, 27 pF (270) between molded inductors L8 and L10.
- Install capacitor C8, .1 μ F (104) directly above molded inductor L9.

- Install capacitor C2, 27 pF (270) between capacitor C55 and diode D4 on the lower edge of the board.
- Install capacitor C21, .1 μ F (104) at the lower right-hand corner of the board.
- Install the following capacitors between the printed outlines for potentiometers R2 and R3 in the lower right quadrant of the board.
 - _ C17, .1 μ F (104)
 - _ C18, .1 μ F (104)
 - _ C19, .022 μ F (223), LS 0.2"
- Install capacitor C22, .01 μ F (103) on the right hand edge of the board above the printed outline for J4.
- Install capacitor C27, 150 pF (151) directly above L6 in the upper right hand quadrant of the board.
- Install the following capacitors in the upper right quadrant of the board.
 - _ C47, 220 pF (221) in the upper right corner of the board.
 - _ C54, 56 pF (56), to the left of C47.
 - _ C49, 1000 pF (102) below C54.
 - _ C48, 1000 pF (102) next to C49
 - _ C46, 470 pF (471) next to C54

Locate C45, 68 pF (68 or 680), LS 0.2. Be sure that you do not confuse this capacitor with C56, also 68 pF but with 0.1" lead spacing, that has not been installed yet. **Note:** C45 may be a much larger disc type, which would not fit in the location for C56. But if both are small, you'll need to go by the lead spacing.

Install capacitor C45 to the left of C46 in the upper right quadrant of the board.

Install capacitor C26, 120 pF (121) pillow-style disc ceramic, about 1/2" (1.3 cm) below C45. **Be careful not to put this capacitor in the space for C44.** When C26 is installed, the space for C44 between C26 and C45 should be empty.

Test fit capacitor C1, 4.7 pF (4.7) pillow-style disc ceramic, next to the lower right corner of the encoder. The bottom of the round capacitor body should touch the board. If the ceramic coating on the leads runs down too far to allow it to sit against the board, remove the excess by squeezing the coating with long-nose pliers. It will crumble and can be scraped away from the lead.

Install capacitor C1, 4.7 pF (4.7) making sure the bottom of the round body is touching the board.



The following capacitors must be mounted closer to the board than the others. They are installed in the area that lies beneath the optional KXB30 30 meter or KXB3080 30 and 80 meter module. The KXB30 or KXB3080 module will not fit if these capacitors sit too high above the board.

The capacitors installed in this step must be closer to the board than any of the previous parts you have installed. After installation, these capacitors must not exceed 5/32" (3.9 mm) in height.

- C11, .1 μ F (104) to the right of molded inductor L10.
- C13, 56 pF (56) to the right of C11.
- Use a ruler to verify that the above capacitors are no higher than 5/32" (3.9 mm) above the board.

On the bottom of the board, ensure L5 (installed earlier) is against the board, or it may strike other components when the KX1 is assembled.

- Turn the board over so jack J1 is in the upper right corner and locate the printed outline for C15 just to the left of electrolytic capacitor C7 at the center of the board.
- Directly above the location for C15 is one of the soldered encoder pins. If it hasn't been trimmed already, trim it flush.
- Install the following capacitors so that about 1/16" (1 mm) of lead shows between the capacitor and the board, so they can be folded down against the board like you did with C39 earlier. **DO NOT fold these capacitors down against the board until you are instructed to do so in later steps. If you fold them now, you will cover solder pads you must reach to install other parts.**
 - _ C15, .01 μ F (103)
 - _ C3, .01 μ F (103)
 - _ C14, 330 pF (331)
 - _ C9, 01 μ F (103)
- Install relay K1 (AGN2104H) to the left of R28 in the upper left quadrant of the board as follows:
 - _ Position the relay on the board. It will only fit one way.
 - _ Hold the relay in place and solder just one of its middle pins to hold it in place.
 - _ Re-heat the soldered pin while pressing down on the relay. This will ensure that it is flush against the PC board.
 - _ Solder the remaining pins.
 - _ Trim all of the pins as short as possible.
- Install relay K2 (AGN2104H) to the left of K1 following the same procedure.

- Turn the board face up so that KX1 is in the upper left corner.
- Locate the pins for K1 in the upper right quadrant. Install C56 (68) between pins 2 and 3 of K1 as shown in Figure 13. There are no solder pads for C56. Cut the two relay pins and solder the capacitor leads directly to the pads for the relay pins. Be sure the capacitor does not exceed 5/16" (7.9 mm) in height above the board.

**C56 IS SOLDERED DIRECTLY TO
PINS 2 AND 3 OF
RELAY K1.**

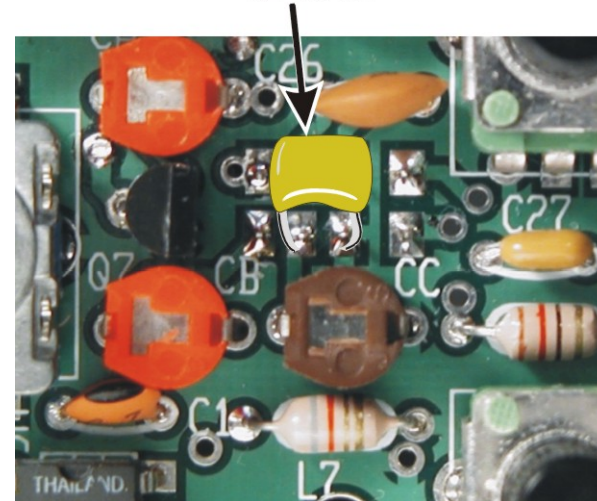

Note: There are a number of components shown in this picture that you have not installed yet.

Figure 13. Installing Capacitor C56.

Install electrolytic capacitor C53 (10 μ F, 35 V) between diode D4 and capacitor C21 in the lower right corner of the board as follows:

- Insert the capacitor with the longer lead through the square pad with the + symbol printed next to it. Check to ensure the strip and minus (-) sign on the capacitor is on the side opposite the + sign on the board.
- Solder one lead and be sure the capacitor is firmly against the board. Measure the height above the board and confirm that it is less than 5/16" (7.9 mm) If necessary, reheat the lead while pressing down on the capacitor.
- Solder the remaining lead and trim both leads.

Install the following electrolytic capacitors using the same procedure:

- C23 (100 μ F, 10 V) about 3/4" (1.9 cm) above C53.
- C20 (10 μ F, 35 V) above C23.
- C35 (100 μ F, 10 V) next to C50 above the upper right corner of the 3-digit display.



If you're not wearing an anti-static wrist strap, be especially careful to touch a ground frequently while installing integrated circuits U4, U5 and U6 in the following steps.

With the board face up so that KX1 is in the upper left corner, locate the printed outline for U4 on the right hand edge of the board below U3. Install integrated circuit U4 (LM386) as follows:

- Straighten the pins as necessary (see Figure 5).
- Orient U4 so that the notch at the end is over the notch in the printed outline on the board and pin 1 is in the round solder pad (see Figure 11).
- Bend the pins at opposite corners of U4 outward slightly to hold it in place.
- Check to be sure that U4 is resting against the shoulders of all 8 pins on the top of the board.
- Solder and trim all 8 pins.



Type NE612, NE602, SA612, and SA602 integrated circuits are all functionally identical. Any of these may be supplied for use at U5 and U6.

Install U5 (NE/SA612 or NE/SA602) near L10 and L8 at the lower center of the board. Use the same technique you used above.



In the following step, U6 must be fully seated before soldering or it will interfere with the optional KXB30 30 m or KXB3080 30 and 80m module. To ensure it is properly seated, a different installation method will be used.

Install U6 (NE/SA612 or NE/SA602) near encoder Z1 at the center of the board. **Solder just one pin of U6.**

Re-heat the soldered pin of U6 *while pressing down on the it from the other side*. You may hear or feel it settle into a lower position on the board. Once you're certain that it is mounted as close to the board as possible, solder the remaining pins.

Install transistor Q9 (2N4124) to the right of U5. Be sure to orient the transistor according to the outline on the board (see Figure 10) and insert the transistor so that the top is no higher than $5/16''$ (7.9 mm) above the board.

Install transistor Q8 (2N4124) as shown in Figure 14. Bend the leads so that the transistor body fits within the printed outline with the flat side facing up. The round back of the transistor must lie against the circuit board so that the transistor does not exceed $5/32''$ (3.9 mm) in height above the board.

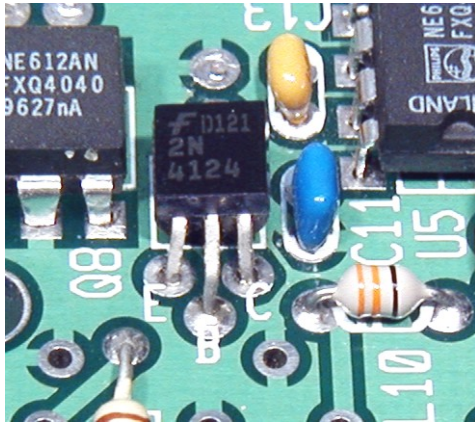

Figure 14. Installing Transistors Q2, Q3 & Q8. The Round Back of the Transistor Must Rest Against the Board.

Install JFET transistors Q2 and Q3 using the same procedure as Q8:

- _ Q2 (J309) to the right of Q8.
- _ Q3 (J309) below Q2
- _ Measure each transistor to ensure it does not exceed $5/32''$ (3.9 mm) in height above the board.

On the bottom of the board, check the leads for JFET Q2 and integrated circuit U6 to be sure they are soldered and cut flush.

Fold down against the board the capacitors you installed earlier as follows. Measure each capacitor to ensure that it does not exceed $1/8''$ (3 mm) in height above the board.

- _ C15 toward the "G" printed on the board.
- _ C3 over the pins for integrated circuit U6.
- _ C14 toward C3 and the pins for integrated circuit U6.
- _ C9 over the pins for JFET Q2 (away from the large hole in the board).

Turn the board face up with KX1 in the upper left corner and locate the printed outline for trimmer CA just above transistor Q7 and the upper right corner of encoder Z1.

- Install trimmer CA as follows:
 - _ Place a red trimmer in the CA position with the flat side of the trimmer over the flat side on the printed outline.
 - _ Press the trimmer down against the board and spread the pins to hold it in place. Note that the adjustment for the trimmer is not visible from the top. It is accessed from the bottom through the hole in the board.
 - _ Check to ensure the trimmer is sitting directly against the board and then solder and trim both pins.
 - Install trimmers CB and CC using the same procedure as CA:
 - _ CB (red) directly below transistor Q7 on the right side of encoder Z1.
 - _ CC (brown) to the right of trimmer CB.
 - Bend ceramic capacitor C1 so that it touches the side of trimmer CB. This will ensure that it does not interfere with the KXB30 or KXB8030 option when it is installed.
 - Turn the board over so the bottom is facing up and jack J1 is in the upper right corner.
- Open the package for four crystals: X2, X3, X4 and X5. The four crystals are identical.
-  **While installing crystals in the following steps, be careful not to flow too much solder onto the leads. Too much solder may wick through the plated hole and cause a short to the case under the crystal were it cannot be seen.**
- Install crystal X2 (4.9136) as follows:
 - _ Insert X2 (4.9136) into the board over the printed outline just below electrolytic capacitor C7. The crystal may go into the holes either way around .
 - _ Note the location of the ground solder pad near the crystal.
 - _ Remove the crystal and solder to the case a discarded component lead no more than 3/16" (4.5 mm) above the bottom of the crystal where it will go straight down through the ground solder pad. If desired, you may attach the ground lead after installing the crystal.
 - _ Place the crystal on the board, threading the leads through the solder pad holes.
 - _ While holding the crystal vertical and firmly against the board, wet your soldering iron with a drop of solder on the tip and tack-solder one of the crystal leads.
 - _ Check to ensure the crystal is flat against the board and perpendicular to the board. If necessary, reheat the lead while adjusting the position of the crystal.
 - _ Solder and trim the remaining crystal and ground leads.

Install remaining filter crystals using the same procedure you used for X2.

- _ X3 (4.9136)
- _ X4 (4.9136)
- _ X5 (4.9136)

Turn the board so the bottom face is up with J1 in the upper right corner and locate the printed outline for antenna jack J2 in the upper left corner.

 **The next step requires an unusually large amount of heat for soldering. Use a larger soldering tip if available.**

Position jack J2 on the board so it is sitting within the printed outline as shown in Figure 15.

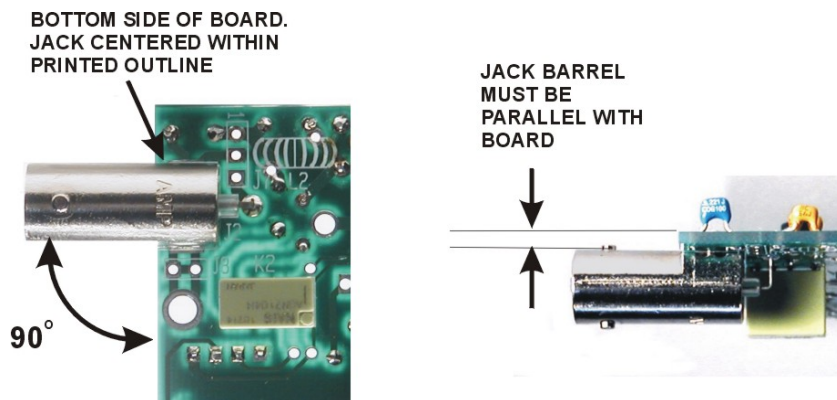



Figure 15. Installing J2.

 **Be certain the jack is mounted on the BOTTOM face of the circuit board as shown. It is very difficult to remove this jack without damaging the board if it is installed incorrectly.**

Solder the center pin lead and recheck the alignment.

Without disturbing the alignment of the jack, solder one of the heavy ground nubs to the board. Then re-check the alignment. Reheat the nub, if necessary, to correct any misalignment.

 **The case will not close during final assembly if the jack is not aligned as shown.**

Solder the second nub on the jack and make a final alignment check.

 **If you fitted your soldering iron with a larger tip to install J2, replace it with a fine tip now.**

Turn the board face up with KX1 in the upper left corner.

Fit headphone jack J4 in the printed outline in the lower right corner. The jack has six plastic nubs that hold it up off of the board slightly. The pins will be flush with the solder pads on the bottom of the board.

Solder one pin and carefully recheck the position of the jack to be sure all the plastic nubs are against the board. If necessary, reheat the soldered pin while pressing down on the jack.

Solder the remaining pins. Be careful working around R15 and R25 with your soldering iron.



The optional KXAT1 ATU module plugs directly into connectors J6, J7, and J8, which you'll install in the following steps. They **MUST be positioned vertically (not tilted) or the ATU module cannot be installed.**

- Turn the board bottom face up with jack J1 in the upper right corner.
 - Install two-pin jack J8 on the board just below antenna jack J2 in the upper left corner as follows:
 - _ Hold the jack vertical with your finger while tack-soldering one pin.
 - _ Carefully inspect the jack to ensure it is vertical with respect to the board and both ends of the jack are down against the board.
 - _ Solder the pins, reheating the one you tack-soldered last to ensure a good joint.
 - Install the following jacks using the same procedure.
 - _ J7, three pins, just above J2 in the upper left corner.
 - _ J6, five pins, just below J1 in the upper right corner.
 - Separate the three potentiometers according to their values:
 - _ Two 1k pots (B1K)
 - _ One 10 k pot (B10K)
- Turn the board top face up with KX1 in the upper left corner.
 - Install potentiometer R2 (B10K) as follows:
 - _ Locate the printed outline for R2 next to electrolytic capacitor C20 on the right side of the board. This is the **CENTER** of the three outlines.
 - _ Position R2 (B10K) so the three signal pins and two large mounting tabs are in the holes in the board.
 - _ Press down on the potentiometer until it rests solidly against the board on the two metal nubs next to each mounting tab and the shaft extends straight up at right angles to the board.
 - _ Solder one of the smaller pins, then recheck the alignment to make sure the pot has not been moved.
 - _ Solder and trim the remaining small pins.
 - _ Solder the two large pins using just enough to make a good electrical and mechanical joint between the tab and the plated hole. **Do NOT try to fill the hole with solder.**
 - Install potentiometers R1 and R3 following the same procedure.
 - _ R1 (B1K) above R2.
 - _ R3 (B1K) below R2.

 In the following steps you'll wind and install toroidal inductors L1 and L2. They must be wound as exactly indicated in the instructions or the transceiver will not operate correctly.³

Turn the board bottom face up with J1 in the upper right corner. Locate the printed outlines for L2 and L1 in the upper left corner near J2.

Locate the four toroid cores. There are two yellow T37-6 cores and two dark gray FT37-43 cores. Use the yellow cores to make L1 and L2.

 Although the yellow and gray cores look similar, they have very different electrical properties. You must use the yellow cores for L1 and L2. The transceiver will not work if you use the wrong cores. See *Identifying Toroid Cores*, page 9, for more information.

- Wind L2 first as follows:
- _ Cut a 13" (33 cm) length of red enameled wire.
 - _ "Sew" the long end of the wire through the hole in the core for a total of 14 turns as shown in Figure 16. Count one "turn" each time the wire passes through the center of the core. There are no "half" or "quarter" turns when winding a toroid. Match the winding direction shown in the figure or the leads won't line up with the solder pads on the circuit board.
 - _ Spread the turns around the core so the finished result looks like Figure 16.

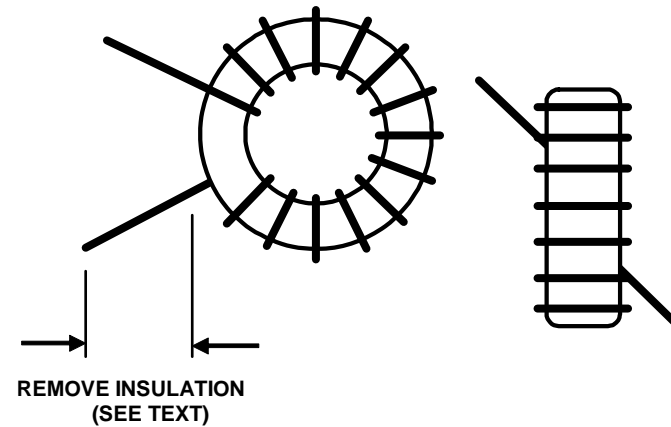



Figure 16. Toroidal Inductor L2.

 In the next step the toroid leads will be stripped and tinned. The leads must be prepared correctly to provide good electrical contact when installed.

³ Prewound toroids are available from an Elecraft-approved source. See www.elecraft.com for details.

- Strip the insulation and tin the leads of both inductors using *one* of the following techniques:
 1. Heat Stripping:
 - a. Place a small amount of solder (a.k.a. a “blob” of solder) on your soldering iron.
 - b. Insert the clipped end of the wire into the hot solder. If the iron is hot enough, you should see the insulation bubble and vaporize after 4 to 6 seconds.
 - c. Add more solder and feed more wire into the solder as the enamel melts. Continue tinning the wire up to the edge of the core, and then slowly pull the wire out of the solder.
 - d. If any enamel remains on the lead, scrape it away using your thumbnail or sharp tool.
 2. Burning: The insulation can be burned off by heating it with a butane lighter for a few seconds. Use sandpaper to remove the residue, then tin the bare wires.
 3. Scraping: Use a sharp tool to scrape the insulation away. Work carefully and gently: *do not nick the wire*. Work around the entire circumference of the wire to remove all of the enamel and tin the bare wires.
- Place L2 over the printed outline on the board and thread its leads through the solder pads.

Pull the leads tight so the toroid is sitting upright and against the board. Check to see that some tinned lead is visible above the pad near the toroid when the wire is pulled tight. If necessary, remove the toroid and tin the lead closer to the core. It won't matter if the tinned wire touches the core itself. The toroid core is not a conductor.

Solder both leads.

Use your DMM to check for continuity across the solder pads. It should be less than 1 ohm. If it is higher, you probably have a poorly tinned toroid lead. Sometimes the leads look like they are soldered, but because there is a film of enamel still on the lead, it is not making contact with the solder pad. If the resistance is greater than 1 ohm, remove the toroid, clean and re-tin the leads and reinstall it.

Wind and install L1 using the same procedure except that L1 has 13 turns. Use the second yellow toroid core for L1.



Do NOT attach L1 or L2 to the circuit board with adhesive, varnish, etc. The toroids will be adequately supported by their leads. Adhesives or other compounds may damage the enamel wire.

Bend a discarded 1/4-watt resistor lead into a “U” shape and insert it into J7 pins **1** and **3** (J7 is the **3-pin connector** adjacent to antenna jack J1; do not insert the wire into the 2-pin connector, J8). This jumper completes the antenna circuit when the optional KXAT1 ATU is not installed.

- Your kit includes an extra 22 k resistor (red-red-orange) for use at R32. This resistor is not present on the Revision B or B1 PC boards. It must be soldered in place in the location shown below, on the bottom of the board between pins 2 and 3 of U4 (LM386N). (It could also be soldered across the pins of C19, nearby, which may be easier.) Trim and bend the leads approximately as shown.

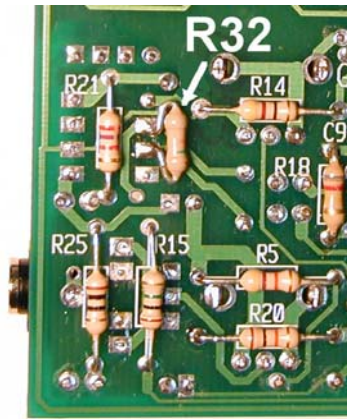

- Make sure R32 is pressed flat against the bottom of the board. Its leads must not be touching any adjacent pads, traces, or components.

Visual Inspection

- Verify correct orientation (banded end) of diode D4, using the parts placement drawing (Appendix F).
- Verify the correct orientation of each electrolytic capacitor. The side of the capacitor with the strip and minus (-) sign must face away from the + sign printed on the board.
- Examine both sides of the PC board closely for solder bridges, cold solder joints, or unsoldered components.

Resistance Checks

- Make the resistance checks listed below with your DMM's negative (-) lead connected to circuit board ground at the hole next to capacitor C6.

Test Point (+)	Resistance
U4 pins 2 & 3	> 10k
U4 pin 4	< 5 ohms
U4 pin 6	> 1k
U4 all other pins	> 10k
U5 pin 3	< 5 ohms
U5 pin 4, 5, 6 & 8	> 1k
U5 all other pins	> 10k
U6 pin 3	< 5 ohms
U6 pins 4, 5, 6 & 8	> 1k
U6 all other pins	> 10k

Alignment and Test - Part II

- Temporarily mount the VFO knob on the shaft of encoder Z1.



Due to the small size of the KX1's front panel, knobs are not appropriate for use on the RF GAIN, FILTER and AF GAIN controls. The shafts of these potentiometers, which are knurled and have molded index marks, are designed to function as knobs.

- Unwrap the cover and set it near the circuit board so you can see the legends identifying the controls and their functions.
- Set AF GAIN fully counter-clockwise (minimum volume).
- Make sure the POWER switch is turned OFF (S2).
- Plug your power supply or battery into J1.
- Turn on power to the KX1. The 3-digit LED display should show the operating frequency. **If not, disconnect the power source immediately.** Locate the source of trouble before proceeding.

Relay Test

- Tap **BAND** twice, quickly, to change bands. You should hear relays K1 and K2 switching.
- If necessary, use **BAND** again to return to 7 MHz.

Sidetone Generator and Audio Amplifier

- Plug in a pair of stereo headphones at J4 (at the right end of the board), and rotate the AF GAIN control clockwise to about 12 o'clock.
- Tap **MENU** and use the VFO knob to locate the **STL** (sidetone level) menu entry. Since you have no antenna connected, you may hear some digital switching noise as you rotate the VFO knob or press switches.
- The sidetone level is set by editing the **STL** menu parameter. Hold **EDIT** to show the parameter and turn on the sidetone. You can then rotate the VFO knob to vary the sidetone level, from **0-3**. Select a comfortable level, then tap **MENU** to turn off the sidetone and return to the **STL** display.

Note: **STL** sets the sidetone volume level in relation to normal received audio. The AF GAIN control sets the overall volume for both received signals and sidetone.

Select the sidetone pitch menu entry (**STP**) using the VFO knob. Hold **EDIT** to turn on the sidetone and edit the pitch parameter. The pitch can be varied from **500** to **650** Hz using the VFO knob. Select the desired pitch, then tap **MENU** to end parameter edit and return to **STP**.

Tap **MENU** again to return to the normal display.

S-Meter and Voltmeter Displays

The **DISP** function (holding **BAND** + **RIT** together) selects one of three display modes. On power-up, frequency display mode will be in effect. Hold **BAND** + **RIT** to select S-meter mode, which will flash a 6-segment bar graph across the upper portion of the display. The display may then go blank or show 1 or more segments, since the S-meter has not been calibrated. (The **SIG** menu entry is used for this purpose; it is described later.)

Hold **BAND** + **RIT** together again to select voltmeter mode. You should see **BAT** (battery) flash briefly on the LED. Your approximate power supply or battery voltage will then be displayed and will flash slowly.

Return to frequency display mode by holding **BAND** + **RIT** again. **nor** (normal) will flash briefly before the frequency is displayed.

Keyer

Plug a keyer paddle into the key jack (J3). *The paddle must have a stereo (2 circuit) plug.* If you don't have a keyer paddle, you can still test the DOT and DASH lines by unscrewing the shell from the supplied stereo plug and inserting it in the KEY/PADDLE jack. Use a clip lead or a screwdriver to short the tip or ring terminals to the ground terminal to trigger dots or dashes.

Tap **MENU** and rotate the VFO knob to locate the **INP** menu entry (CW input device selection). Hold **EDIT** to see the parameter. Turning the VFO knob selects **HND** (hand key or external keyer), **PDN** (paddle normal) or **PDR** (paddle reverse). Tap **MENU** twice to return to the VFO display.

The keyer speed may be varied from 8 to 50 WPM. Display the keyer speed by holding **SPEED**, then adjust it using the VFO knob. Tap any switch to return to the frequency display. (The KX1 does not transmit when adjusting the keyer speed.)

While listening with headphones, test the keyer paddle to verify that both dot and dash are working.

Receiver Alignment

There are two receive band-pass filters to align. The trimmer capacitors are adjusted through the bottom of the board as shown in Figure 17. The 14 MHz (20 meter) filter has two adjustments, labeled 20A and 20B on the PC board, while the 7 MHz (40 meter) filter has just one, labeled 40.⁴

Two additional holes, labeled 30A and 30B, are provided for use with the optional 30-meter or 30/80 meter modules (KXB30 or KXB8030).

The 14 MHz (20 m) trimmers must be aligned first, then the 7 MHz (40 m) trimmer, as explained in the following steps.

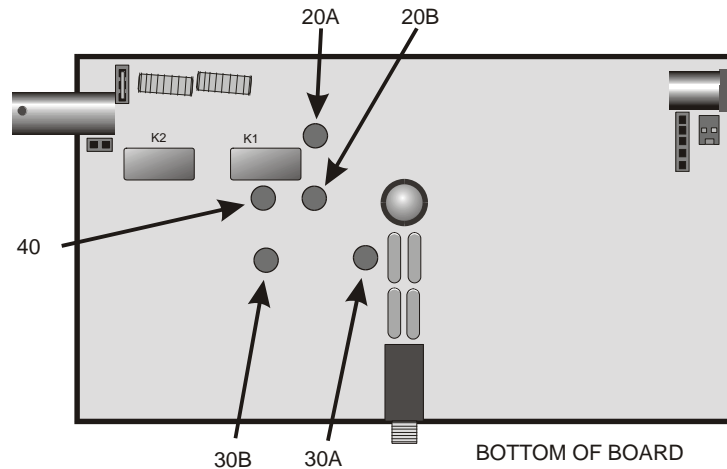

Figure 17. Trimmer Adjustments.

- Set the RF GAIN control fully clockwise.
- Set the FILTER control fully clockwise.
- Plug in a pair of headphones or an external speaker, and adjust the AF GAIN control until you hear some background noise. If you do not hear any noise, refer to Troubleshooting.
- If the present band is not 14 MHz (20 m), tap **BAND** twice quickly to select it.
- Set the VFO to about 14100 kHz. Tap **BAND** if necessary to verify that you're in the right 100-kHz segment.
- Connect an appropriate antenna for the 20-meter band. At minimum, connect approximately 15-30 feet (5 to 9 meters) of any type of wire to the center conductor BNC connector J2. In general, the longer and higher the antenna, the more signal strength that will be available during receiver alignment.



Receiver alignment will be easiest if you use a controlled signal, i.e. from a ham-band transmitter, signal generator or noise generator. In all cases, use a signal that is weak enough to not activate the KX1's AGC; otherwise, it will be much more difficult to find the correct settings for the trimmer capacitors. If you use a transmitter, be sure to connect it to a dummy load and operate it at low power.

⁴ Only one adjustment is required on 40 meters because the first tuned circuit is somewhat broadly resonant on this band, allowing the use of a fixed capacitor.

Locate a small flat-blade screwdriver or tuning tool for use in adjusting the trimmer capacitors. Test the tip of the tool to make sure it will through the access holes and can turn the trimmers. If the handle is not insulated, wrap the end with tape to prevent your hand capacitance from affecting the adjustment.

 **The trimmer access holes on the revision B and B1 KX1 PC boards are plated through and grounded. This may make alignment more difficult if you're using a tool with a long metal shaft, rather than a tuning tool with just a metal tip. This is not a safety hazard, but you may need to remove the tool after each adjustment to check the signal amplitude. (The PC board revision letter can be found in the upper left-hand corner of the PC board, on the top side.)**

Tap **BAND** twice, quickly, to select the 14-MHz band.

While listening to atmospheric noise or a weak CW signal, peak trimmer capacitors *20A* and *20B*. If the peak is not clear, reduce the signal input level (the AGC may be getting activated). **Do not turn the RF GAIN control counter-clockwise, as this will broaden the tuning peaks, making them more difficult to identify.**

 **If you don't hear band noise or signals, be sure you installed the jumper across the outer pins of J7 as described on page 41.**

Tap **BAND** twice (quickly) to select the 7 MHz band. Set the VFO to about 7100 kHz.

Switch to an appropriate antenna for this band, if available, or use the wire antenna recommended earlier.

While listening to noise or a weak signal, peak trimmer *40*.

AGC and S-Meter Test

Turn the KX1 on and connect an antenna or signal generator.

S-meter display mode provides a bar graph to indicate approximate received signal strength. To select this mode, hold **BAND** + **RIT**. You'll see a brief bar-graph test pattern, then the display may go blank or show one or more bars.

Tune in a strong signal. (Whenever you move the VFO, the S-meter bargraph will be replaced with the frequency display.) Once the signal is tuned in, the AGC should be activated, as indicated by an increase in S-meter reading.⁵ The S-meter zero point and scale can be adjusted, if necessary, using the **SIG** menu entry (page 65).

 **Since the KX1 uses audio-derived AGC, the initial code element from a very strong station may be heard at a louder volume. This is due to the time it takes for the AGC detector capacitor, C53, to charge. This effect is lessened somewhat by the limiting action of U4 (AF amp), since U4 is operated from a low voltage. (See schematic, Appendix B.)**

⁵ Each bar corresponds to roughly two S-units, so that 4 or 5 bars indicates about an "S-9" signal.

Receive Current Drain Test (Optional)

The current drain in receive mode is about 35 mA (with the **LED** menu entry set to **0, 1, or 2**). If the current drain is significantly lower or higher than this, it could indicate a problem.

To check the current drain, set your DMM for DC milliamps and temporarily insert the DMM in series between the KX1 and the power supply. Turn the KX1 on and note the current: _____ mA.

Operating Frequency Calibration (Optional)

The operating frequency display may be off by as much as $\pm 200\text{Hz}$ until calibrated, due to variations in the 50-MHz reference oscillator and BFO components. Accuracy can be improved to approximately ± 10 or 20 Hz using the **BFO** and **DDS** menu entries.

While it is possible to do operating frequency calibration at this time, we recommend that it be done after assembly and test have been completed. The calibration procedure is described on page 68.

Assembly - Part III

In Part III you'll install and test the transmitter and lowpass filter components.

Remove the VFO knob if you haven't done so already.

Turn the board top face up with KX1 in the upper left corner. Install the following 1/4 watt resistors to the upper left of encoder Z1:

- _ R9, 300 ohms (org-blk-brn).
- _ R11, 10 ohms (brn-blk-blk)
- _ R31, 1k (brn-blk-red) Note: On some boards, R31 may be printed in reverse (mirror image).

Turn the board bottom face up with jack J1 in the upper right corner. Install the following 1/4 watt resistors near the center of the top edge.

- _ R30, 22 ohms (red-red-blk) above relay K1.
- _ R26, 22 ohms (red-red-blk) above electrolytic capacitor C7.
- _ R27, 22 ohms (red-red-blk) above R26.
- _ R10, 47 ohms (yel-vio-blk) to the right of R27.
- _ R24, 22k (red-red-org) on the top edge of the board above R10.

Install zener diode D7 (1N4756A) next to resistor R30. **Be sure to align the banded end of the diode over the band on the board.**

Install trimmer potentiometer R4, 100 ohms (101), next to diode D7 and resistor R30 as follows:

- _ Position R4, 100 ohms (101), and hold it in place while tack-soldering one pin.
- _ Check to be sure all the shoulders of all three pins are against the board, the solder and trim all three pins.
- _ Set R4 fully *counter-clockwise*.

Turn the board top face up with KX1 in the upper left corner. Install the following capacitors in the area above encoder Z1. Be sure to check the each capacitor to ensure it is no more than 5/16" (7.9 mm) above the board.

- _ C42, .01 μ F (103) to the left of electrolytic capacitor C35 on the top edge of the board.
- _ C34, .01 μ F (103) to the right of electrolytic capacitor C35 on the top edge of the board.
- _ C41, .01 μ F (103) near the upper left corner of encoder Z1.
- _ C43, .1 μ F (104) above C41.
- _ C44, .022 μ F (223) near RF Gain potentiometer R1.



Wear your ESD wrist strap or touch a ground frequently while installing the transistors in the following steps.

- Install the following transistors. Be sure the top of the transistors is not more than 5/16" (7.9 mm) above the board.
- _ Q1 (J309), directly to the right of the three-digit LED display.
 - _ Q5 (2N3904) near the upper left corner of encoder Z1.
 - _ Q4 (2N4124) above Q5 near the upper edge of the board.



In the following steps you'll wind and install toroidal inductors L3 and transformer T1. They must be wound as exactly indicated in the instructions, or the transceiver will not operate correctly.⁶

- Turn the board bottom face up with J1 in the upper right corner. Locate the printed outlines for L3 and T1 near the top center of the board to the right of trimmer pot R4.
- Locate the two dark gray FT37-43 cores.

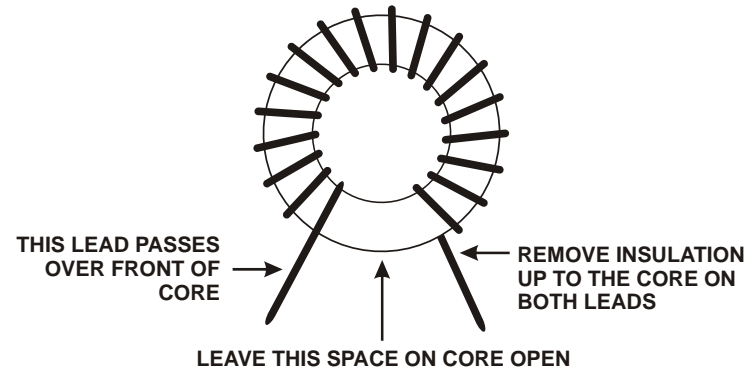

Figure 18. Winding Inductor L3.

⁶ Prewound toroids are available from an Elecraft-approved source. See www.elecraft.com for details.

Wind toroidal inductor L3 on one of the FT37-43 cores as follows:

- Cut a 14” (36 cm) length of red enameled wire.
- “Sew” the long end of the wire through the hole in the core for a total of 18 turns. Match the winding direction shown in Figure 18. Count one “turn” each time the wire passes through the center of the core. There are no “half” or “quarter” turns when winding a toroid.
- Spread the turns around the core so the finished result looks like Figure 18.
- Strip the insulation and tin the leads like you did earlier for L1 and L2 (See page 41).

Wind toroidal transformer T1 on the remaining FT37-43 core as follows:

- Cut an 8” (20 cm) length of red enameled wire.
- “Sew” the long end of the wire through the hole in the core for a total of 8 turns. Match the winding direction shown in Figure 15. Count one “turn” each time the wire passes through the center of the core. There are no “half” or “quarter” turns when winding a toroid.
- Spread the turns around the core so the finished result looks like Figure 16.
- Cut a 6” (15 cm) length of green enameled wire.
- Wind two turns in between the other winding exactly as shown in Figure 19.
- Strip the insulation and tin all four leads like you did for the other inductors.

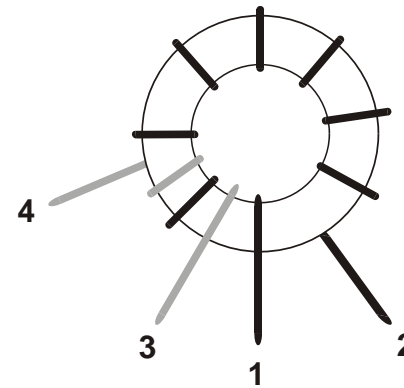

TIN ALL FOUR LEADS UP TO THE CORE.

Figure 19. Winding Transformer T1.

Install toroidal transformer T1 first as follows. It will be easier to thread all four leads through the proper holes in the board if you install it before L3.

- Thread the leads through the holes in the board. **Double check to ensure you have the right leads in the right holes** (see Figure 19). The inductor stands up vertically over the printed outline. You will notice that lead 4 cannot be pulled tight without dislodging the turns. This is normal. Leave enough slack in that lead to avoid disturbing the position of the winding.
- Solder all four leads.
- Use your DMM to check for continuity between pins 1 and 2, then between 3 and 4. The resistance must be less than 1 ohm in both cases. If it is higher, you probably have a poorly tinned toroid lead. It must be fixed before continuing.

- Install toroidal inductor L3 and solder both leads. Check for continuity (less than 1 ohm) between the solder pads.

 Do NOT attach L3 or T1 to the circuit board with adhesive or other compounds. They should be supported only by their leads.

- Install two pairs of standoffs in the holes at the edges of the board as shown in Figure 20. The front panel / top cover will attach to the short standoff. One pair of standoffs installs near J8 and K2 (on the bottom face of the board) and the other pair installs in the hole near P1 and J6.

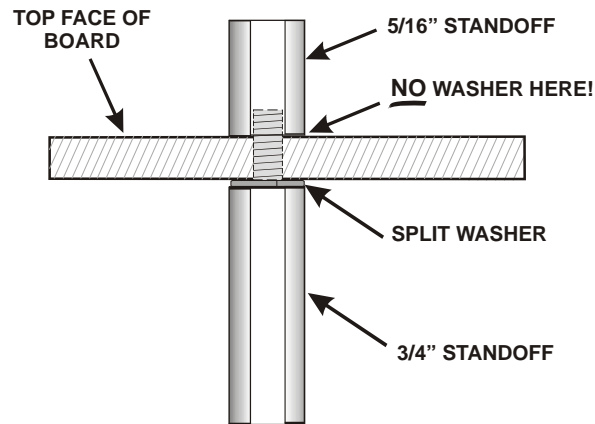

Figure 20. Installing Standoffs on Circuit Board.

- Place the front panel (top cover) face down on a soft cloth to avoid scratching it.

- Remove the paint from around the screw holes where the short standoffs will contact the front panel as shown in Figure 21. Use sandpaper or a sharp knife. Clean the panel thoroughly to remove all of the residue when you are done.

- Inspect the area where the thermal pad will mount and be certain there are no burrs that could poke through the thermal pad. Burrs are most likely to be found around the hole. Sand file any rough edges smooth.

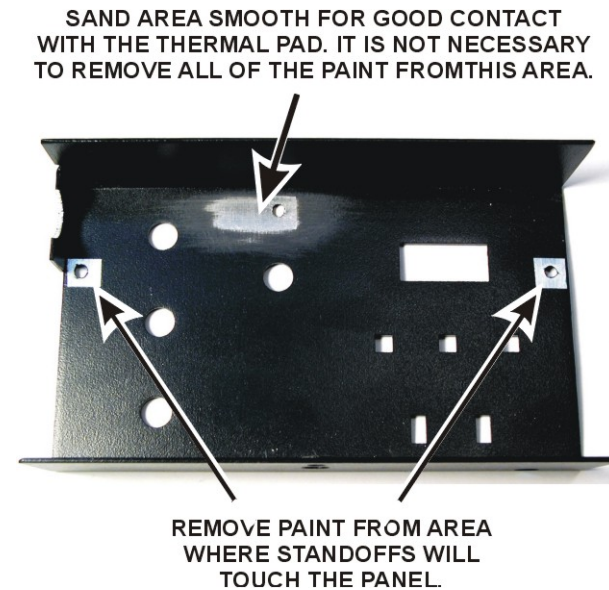

Figure 21. Preparing Top Cover for Installation.

□ Locate the thermal pad. Leave it on the backing paper while you remove the piece filling the hole near one end. Then remove the backing and place the pad on the inside of the cover over the area you sanded with the hole in the pad aligned with the hole in the cover (see Figure 22).

POSITION THERMAL PAD OVER SANDED AREA AS SHOWN. Q6 MUST PRESS AGAINST THE PAD TO PROVIDE EFFICIENT HEAT TRANSFER AND TO PREVENT AN ELECTRICAL SHORT TO GROUND.

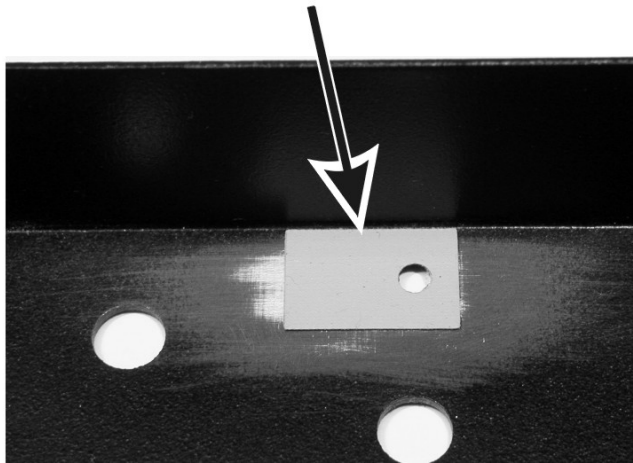
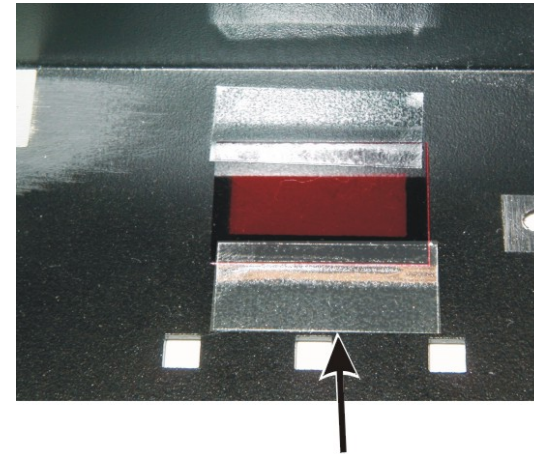

Figure 22. Installing Thermal Pad.

□ Position the red filter over the LED display opening. Use the clear tape to secure it on the top and bottom edges as shown in Figure 23. Even though the tape is transparent, keep it outside of the window area so the edge of the tape is not visible from the front of the unit. **Be careful not to cover the pushbutton switch holes with the tape.**



DO NOT COVER PUSHBUTTON HOLES!

Figure 23. Installing Display Filter.

☐ Check your kit to determine whether a 2SC2166 (metal tab) or a 2SC5739 (black plastic tab) transistor was supplied. Both transistors provide equal performance, but their installation is different because the metal tab on the 2SC2166 must be insulated from the mounting hardware. Install the transistor exactly as described in the following steps.

☐ Bend Q6's leads into a gentle 90-degree curve (see Figure 24). Note that the flat side of the transistor faces **away** from the circuit board. Wrapping the leads around a round screwdriver shaft or drill bit helps avoid sharp kinks in the bend.

☐ Locate the silk-screened outline for Q6 at the top edge of the circuit board. Install the 3/16" (4.76 mm) standoff on the circuit board using a 3/16" pan head screw and two split washers as shown in the figure. **The split washer under the standoff is important to reach the proper height so Q6 will come in contact with the cover.** Be sure the screw head or washer is not touching the windings on L3 on the bottom of the board. They may touch the toroid core in the space between the windings.

☐ Place Q6's leads in the holes in the circuit board. **Do not solder them until instructed to do so.**

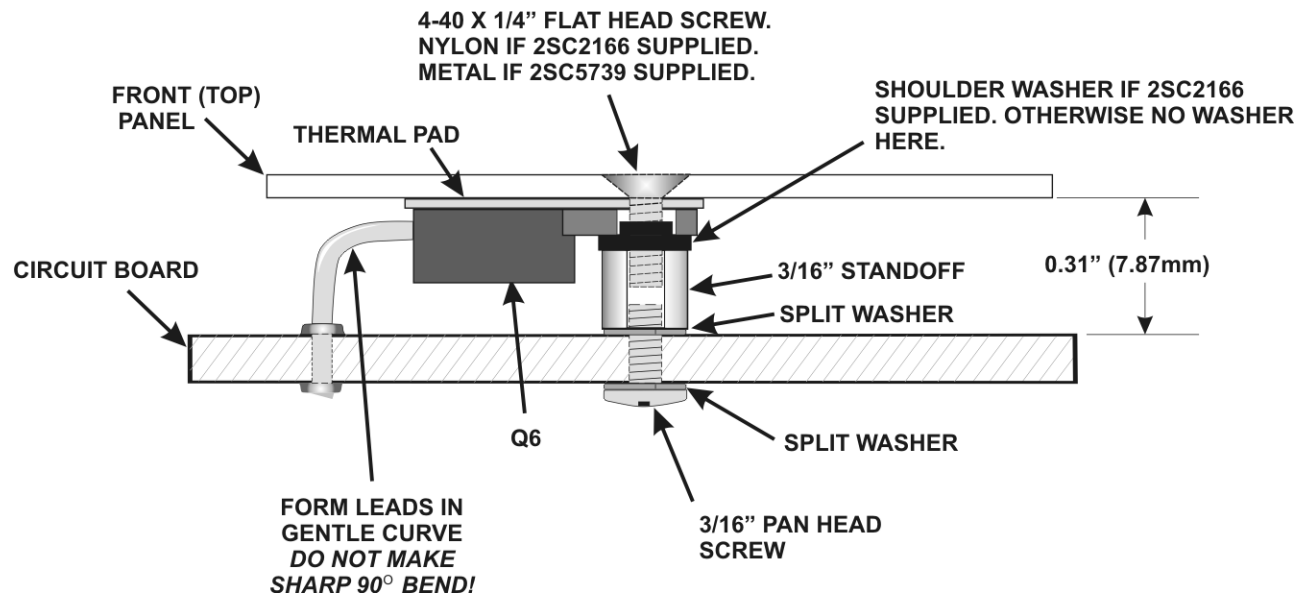



Figure 24. Installing Power Amplifier Q6.

- Temporarily secure Q6 to the standoff with a 4-40 flat head screw. Tighten the screw enough to hold Q6 securely and parallel to the circuit board.
- Use your long-nose pliers to adjust the leads so the flat side of the transistor is parallel to the circuit board. The flat side must face AWAY from the board. It will rest against the thermal pad you installed in the top cover and must make good contact to transfer heat efficiently.
- Solder the three leads to Q6. Trim them flush on the bottom side of the board.
- Remove the flat head screw holding Q6.** If a 2SC2166 is installed, the soldered leads should hold the shoulder washer in place.
- Conduct a thorough visual inspection of the board. Use a magnifier. Check especially for the following:
 - Diode D4 is oriented correctly as shown in the Parts Placement diagram in Appendix F.
 - All joints soldered with no shorts between solder pads.
 - All components installed. On the bottom are some labeled pads that will have no wires in them. They are connection points for the optional KXB30 30 meter or KXB3080 80 meter band module. These pads are labeled “A”, “B”, “C”, “D”, “5” and three pads labeled “G”.

 **If you installed a 2SC2166 (metal tab) transistor at Q6, NEVER install a metal screw in the tab of Q6 when the unit is out of its case for testing. The metal tab of Q6 is connected to the + side of the power supply and the screw will short the supply to ground when power is applied. This may cause serious damage to the circuit board or other components.**

- Connect your DMM ground lead to one of the metal stand-offs mounted on the board and make the following resistance checks:
 - Q4 Emitter (terminal farthest from edge of board) 20 to 24 ohms
 - Q4 Base (center terminal) > 10k
 - Q4 Collector (nearest edge of board) > 10k
 - Q5 Emitter (terminal farthest from edge of board) 50 to 70 ohms
 - Q5 Base (center terminal) > 10k
 - Q6 collector (metal tab if 2SC2166): > 500 ohms
- Place the three button caps on the pushbutton switches. Press down on each cap to snap it in place.
- Fit the board into the top cover as follows:
 - The control shafts will fit through the holes.
 - If the pushbutton switches don't line up properly with the holes in the cover, use a long tool to reach between the cover and the circuit board to nudge the caps into the holes.
 - Finally, you will need to push down gently on the key jack to make it snap into its hole in the cover.
 - Check the standoffs at both ends and confirm that they are resting against the cover.
- Secure the board to the cover with three 4-40 x 1/4" flat-head screws. **Do not over-tighten any of these screws.**

Turn the unit face down on a soft surface and measure the resistance between either solder pad for toroid L3 and ground. It should be > 500 ohms. If it is less, you must find the cause before proceeding. If the metal tab 2SC2166 is installed at Q6, the most likely cause will be that the shoulder washer has slipped out or the metal tab on the transistor is touching the case instead of the thermal pad.

Install the knob on the encoder shaft.

Find the battery holders and inspect the bottom of one. Note the ridges and nubs that provide a space for wires under the holder. The holder has one wire running between two molded ridges that connect the opposite corner cells together.

In the following steps you will install and wire the battery holders. First, study the wiring drawing in Figure 25. The two holders are wired in series. The wires must run against the bottom cover and under the holders as shown to avoid interfering with other components when the KX1 case is closed.

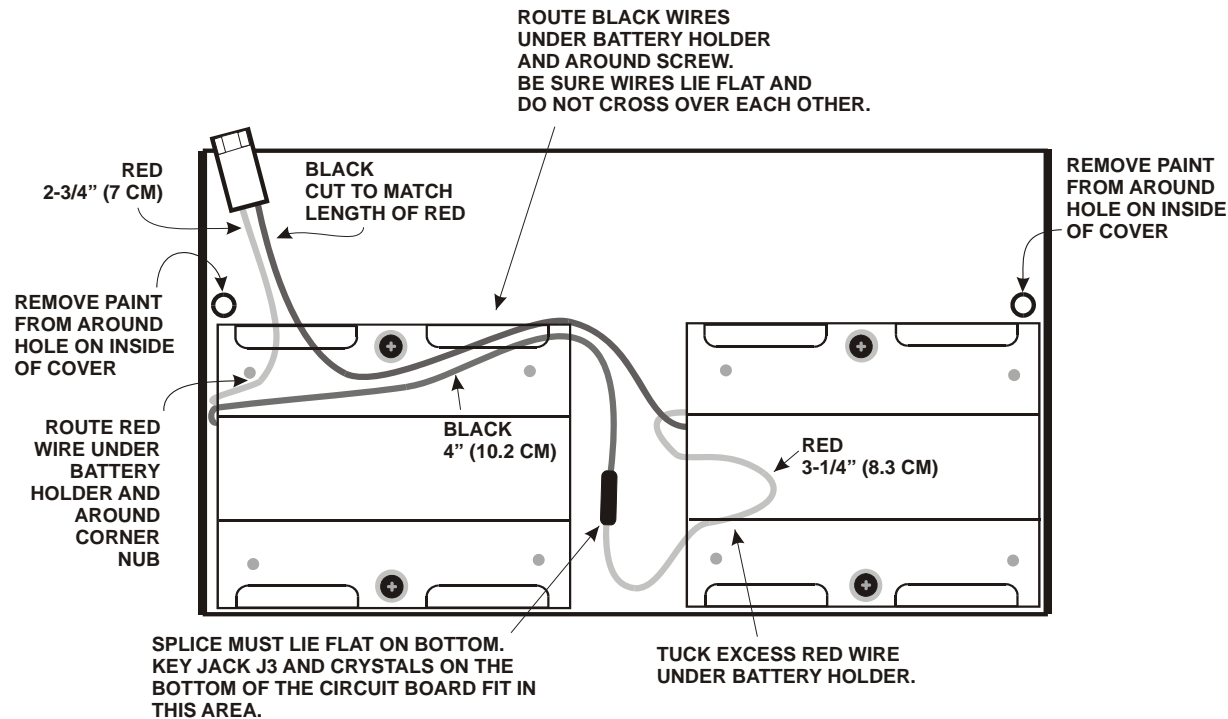

Figure 25. Wiring the Battery Holders.

Begin by removing the paint from around the holes on the inside of the bottom cover where it will attach to the stand-offs on the circuit board. There are two holes; one at each end of the cover (see Figure 25).

Select one battery holder and cut the red wire to 3-1/4" (8.3 cm) in length. Strip 1/4" (6 mm) of insulation off of the end. These are stranded wires. Be careful not to nick or break the strands. Leave the black wire its full, original length.



Repeated insertion and removal of the 2-56 screws used in the following steps may result in stripping the threads in the bottom cover. To avoid this, study the illustration and instructions carefully before inserting the screws. In the event that the 2-56 screw threads do become stripped, you'll need to replace the supplied screws with longer screws, along with 2-56 hex nuts.

Mount this holder in the right hand position as shown in Figure 25 using two 2-56 screws. **Do NOT over-tighten the screws, as this may strip the threads.** Be sure the wires exit at the left end as shown.

On the second holder, cut the wires as follows:

- Red: cut to 2-3/4" (7 cm) in length and strip the insulation off of 1/4" (6 mm) at the end.
- Black: cut to 4" (10.2 cm) in length and strip the insulation off of 1/4" (6 mm) at the end.

Position the second holder on the bottom cover oriented as shown and start a screw in the hole nearest the edge of the cover (closest to the bottom in Figure 25). Do not tighten this screw yet. Leave it loose enough so that the other side of the holder can be lifted up off of the cover far enough to slip wires underneath.

Slip the three wires shown in Figure 25 under the edge of the holder as follows:

- Position the red wire so it goes under the holder and around the nub at the corner.
- Position the two black wires so the screw will prevent their being pulled out from under the holder. **Be sure the wires lie flat and do not cross over each other under the holder.**

Insert the remaining screw in the holder and tighten both screws.

Wiggle all three wires running under the left battery holder to be sure they are not being pinched. You should be able to move the free end of the black wire and see it move where it emerges from under the holder without interfering with the other wires. If necessary, loosen or remove the top screw and adjust the wires so each one lies flat under the holder. Tighten both screws when you are done.

Cut a 1" (2.5 cm) length of the black shrink-tubing supplied and place it over the end of the red wire on the right hand battery holder.

Twist the ends of the red wire from the right holder and the black wire from the left holder together to join them. Make the joint small and smooth. Solder it.

- Slide the shrink tubing you placed on the red wire over the joint and shrink it in place to insulate the connection. You can shrink it using hot air from a blow dryer or by simply placing your soldering iron very close to the tubing and allowing its radiant heat to shrink it. If you place the barrel of a hot soldering iron (the part just behind the tip) where it almost touches the tubing and parallel to it, the tubing should begin to shrink in about 30 seconds. Repeat at two or three places around the tubing to shrink it evenly and snugly.
- Slide the excess red wire under the right hand holder as shown so the splice and wire lies down near the bottom cover. When the unit is assembled, the space between the battery holders is taken up by the Key jack (J3) and the crystals on the circuit board.
- Line up the black wire with the red wire in the upper left corner that will go to the power plug. Cut the black wire to the same length as the red wire and strip 1/4" from the end.
- Locate the crimp terminals and housing for plug J5 (Figure 26). Crimp and solder the terminals to the stripped red and black wires.

- Insert the terminals into the housing until they latch. Tug on the wires to verify that the terminals are locked in place.
- Double check your installation by attaching J5 to plug P1 and verify that the red wire goes to the terminal marked + on the circuit board. If you got them backward, press gently with a thin screwdriver or knife blade in the slots on the housing to release the terminals.

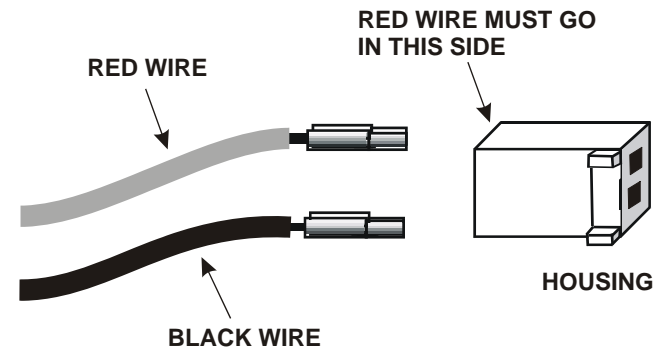



Figure 26. Assembling Battery Supply Jack J5.

 We strongly recommend the use of 1.5-volt cells, preferably 2.9 AH lithium (Energizer type L91) or alkaline. 1.2-volt cells, e.g. NiMH, can also be used, but have some drawbacks. See page 62 for details.

This completes Part III of the Assembly.

Alignment and Test - Part III

- Make sure the KX1 is turned off.
- Connect a 12 to 14-V, 1-amp power supply (or battery) to J1.
- Make sure trimmer R4 is fully *counter-clockwise* (drive level).
- Connect an antenna that is adequate for receiver testing.
- Plug in a pair of stereo headphones or a speaker at J2.
- Turn on the KX1. If the display doesn't appear, turn the KX1 off and disconnect the power supply. Check resistance from the tab of Q6 to ground and from pin 1 of the MCU (U1) to ground. Both should be over 500 ohms. If the tab of Q6 measures low resistance, look for D7 installed backward or a solder bridge across the pins of Q6. If pin 1 of the MCU measures low, put on a wrist strap (or touch ground) and remove U1, then re-check the resistance. If it's still low, you could have a short on the 5-volt or 2.7-volt lines.
- Switch to voltmeter display mode (using **BAND** + **RIT**, twice) to make sure that the battery or power supply voltage is not being pulled down when the KX1 is turned on. If it is, it could indicate a short or incorrect component somewhere in the transmit stages.

- Repeat the receiver alignment steps (page 45). This is necessary because some components added in Assembly Part III may affect the tuning of the receiver's band-pass filters.



If receiver gain seems to be too low after re-alignment, you may have an assembly error in the transmit stages, low-pass filter, or T-R limiter (Q7). Turn the KX1 off, remove the top cover, and re-check the orientation of all diodes, transistors, and ICs. Look for shorts on both the top and bottom of the board in the transmitter area. (Also see Troubleshooting.)

- Turn the KX1 off.
- Connect a 50-ohm dummy load to the antenna jack, along with a wattmeter if available. The dummy load should be rated at 5 watts or higher.
- Connect a key or keyer paddle.
- Set R4 fully clockwise.
- Turn the KX1 on.

 TUNE mode (key-down) is activated by pressing the **MENU** and **BAND** switches together. Tapping any switch or the keyer paddle will cancel TUNE. During TUNE, the display will show **tun**. (If the KXAT1 ATU option is installed, the display will instead show both power output in watts and SWR. Refer to the KXAT1 manual for details.)

20-Meter Transmit Test

Switch to the 14-MHz band using **BAND**. Set the VFO to approximately 14100 kHz.

If a monitor receiver (or transceiver) is available, connect a very short antenna wire (1 to 3 feet) to its RF input and set it to the KX1's indicated VFO frequency.

 **Do not remain in TUNE mode for more than 5 to 10 seconds at a time. If you cannot hear the KX1 in the monitor receiver, or if you suspect there's a problem, cancel TUNE mode immediately and see Troubleshooting.**

Put the KX1 into TUNE mode by holding **MENU** + **BAND**. You should see **tun** on the display. Listen for the KX1's signal in the monitor receiver and/or check the wattmeter indication, then exit TUNE mode by tapping any switch.

 The wattmeter should indicate approximately 3 to 4 watts with a 12-14 V supply. If power is significantly lower than this, the KX1 could be drawing more current than your power supply or battery can handle, or R4 may not be set fully clockwise. If neither of these seems to be the problem, see Troubleshooting.

40-Meter Transmit Test

Switch to 40 meters (7 MHz). Set the VFO to about 7100 kHz.

Put the KX1 into TUNE mode by holding **MENU** + **BAND**. You should see **tun** on the display. Listen for the KX1's signal in the monitor receiver and/or check the wattmeter indication, then exit TUNE mode by tapping any switch.

 If 40-meter power output is less than 3 to 4 watts with a 12-14 V supply, see Troubleshooting.

If both bands have adequate output power but 20 meters is higher, you should adjust the windings of toroidal inductor L2. To do this, "squeeze" the turns of L2 together slightly so that they occupy only about 70% of the core's circumference. With L2 at its optimal turns spacing (for best harmonic rejection), 20 meter output will be about 0.3 to 0.6 watts lower than 40 meters.

Keying Test

Connect a keyer paddle or hand key to the KEY/PADDLE jack.

Key the KX1 while listening in the monitor receiver. The keying should sound clean and stable. During keying, one bar will be shown on the LED bargraph. (If the KXAT1 ATU is installed, the bargraph will instead show approximate power output in 0.5-watt increments (0 to 3 watts).

Turn the KX1 off and disconnect the power supply, key or paddle, and antenna.

Final Assembly

- ❑ Be sure that you removed the paint from around the bottom cover holes (see Figure 25).
- ❑ Three self-adhesive feet are supplied for the bottom cover. Three feet provide excellent stability on uneven surfaces. Position the feet on the bottom as shown in Figure 27.

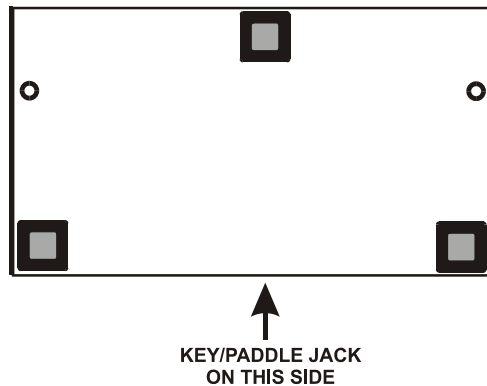

Figure 27. Installing Feet.

- ❑ Place the serial number label inside the top cover as shown in Figure 28. **Note:** The label is placed on the inside to protect it during field operation. You can easily check the serial number when necessary by removing two thumb screws and pulling open the bottom cover.



Figure 28. Installing Serial Number Label.

Components on the bottom of the board must have an overall height of no more than about 1/8" (3 mm) above the PC board in the area shown below (See Figure 29). Fold down or re-solder components if necessary. Also trim any long component leads which were not trimmed earlier.

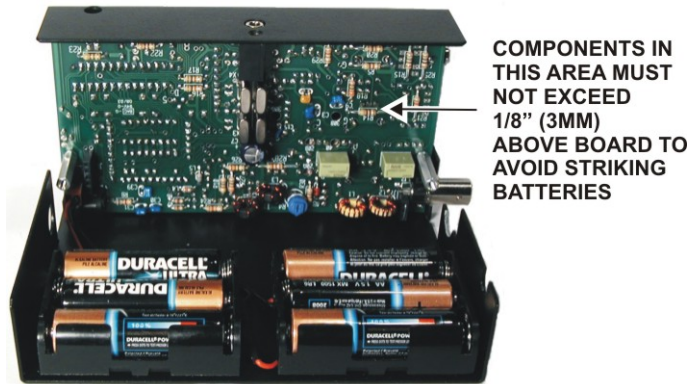



Figure 29. Checking Component Clearance.

Set the chassis (top cover and circuit boards) next to the bottom cover as shown in Figure 29 and attach battery connector J5 to plug P1 on the main circuit board.

 **When you install the bottom cover in the next step, be sure not to pinch the battery cable under the nearby long standoff.**

Fit the bottom cover in place and secure it with the two 4-40 black knurled thumbscrews.

This completes assembly of your KX1 Transceiver. You should have a number of washers, screws, and other hardware left over. These items have been provided as spares. Please read the Operation section, which follows, and try each of the KX1's features. If you're new to QRP, be sure to read the QRP Operating Tips section (page 70).

 **If you have purchased KX1 internal options, do not install them until becoming familiar with basic KX1 operation. Options can be installed in any order. (All KX1 options are described on page 71.)**

Operation

This section covers all KX1 connectors, controls, and operating features. For a one-page **Quick Reference**, see Appendix G.

Connections

Internal Battery

Connect the internal battery to P1 on the PC board. Make sure the battery wires aren't pinched when you install the bottom cover.

Battery Selection: For best performance, use 1.5-volt cells (9 volts—see table). Energizer lithium type L91 or fresh Alkaline cells are recommended. Lithium cells are more expensive, but have high energy density, a flat discharge curve, and weigh less than Alkalines. 1.2-volt cells (e.g. NiMH) can also be used, but will provide lower output and reduced operating time, and near end of charge will not meet the KX1's minimum supply voltage spec (7 V). *You must remove rechargeable batteries (e.g., NiMH) for charging.*

Battery Type	Voltage (6 cells)	Amp-hours	Output (watts)	Weight (6 cells)
Lithium	9 V	2.8-2.9	1.5-2.0	3 oz.
Alkaline	9 V	2.2-2.7	1.5-2.0	5 oz.
NiMH	7.2 V	1.6-2.3	0.75-1.0	5 oz.

Low-Battery Warning: If the supply voltage drops below the value set in the **BAT** menu entry, you'll see **BAT LO** on the LED every five minutes. Set **BAT** to **7.5 V** for Alkaline or Lithium cells, **6.5 V** for NiMH, and **10.5 V** for an external 12 V battery.

External Power Supply

You can connect any 7-14 V DC power supply or battery to J1, although you should use the minimum recommended voltage (8 V) when possible. The KX1 will run from whichever is higher in voltage, the internal battery or the external supply. Transmit current drain will be 300-700 mA, depending on the supply voltage.

Headphones or External Speaker

The AF output jack, J4, can accommodate either headphones or a small speaker (8-32 Ω). A stereo plug is required. Earbud-style headphones are recommended (Sony MDR series or equivalent, with sensitivity of 108 dB/mW). They are lightweight, sensitive, and mask wind noise well.

Antenna

Any resonant antenna can be connected to J7. With the KXAT1 ATU, you can connect random-length wires, often without any feedline (see KXAT1 manual). With a KXAT1 installed, power and SWR will be displayed in TUNE mode, and power output is shown on the bargraph during keying. If no KXAT1 is installed, the display will show one bar on transmit, and **tun** in TUNE mode.

Keying Device

You can connect a hand key or external keyer to J3, or connect a paddle (such as the optional KXPD1) and use the KX1's built-in memory keyer. A stereo plug is required. You can also use the KX1's front-panel buttons to send CW (see page 68).

Controls and Display

Power Switch

Set POWER ON to turn on the KX1. If the LED display is too dim, hold **MENU**, **BAND**, or **RIT** at power-up. This selects maximum LED brightness and also turns on audible CW switch feedback at 10, 20, or 30 WPM respectively (see page 69).

Lamp Switch

Set LAMP ON to turn on the lamp at the front-left edge of the KX1. The lamp can be used to illuminate a log book placed in front of the KX1, or as a flashlight. In an emergency it can be used for visible signaling. The white LED used is extremely efficient. Its current requirement varies with supply voltage, from about 5 mA at 7 V to 15 mA at 14 V. You can substitute a red LED if desired.

LED Display

The 3-digit LED display shows the operating frequency, S-meter or power output bargraph, menu entries, etc. Brightness and 'on-time' are programmable (see **LED**, page 65). You can also use audible CW switch feedback in addition to the display (page 67).

Brightness: The display is most useful in low to moderate lighting situations, where it requires only about 1-3 mA total current. Brighter settings are also available that require up to 10 mA. If the display is too dim when the KX1 is first turned on, you can quickly select maximum brightness, and simultaneously enable CW feedback on switch press, by holding one of the three pushbutton switches when the KX1 is turned on (see Power Switch, above).

Decimal Points: The decimal point shifts to indicate the VFO tuning rate, and is flashed when RIT is enabled.

Bargraph: In S-meter mode, the bargraph indicates received signal strength (see **SIG**, page 65). On transmit, it shows 1 bar per 0.5 W output if the ATU is installed, and 1 bar otherwise.

VFO Knob/Tuning Rate Switch

This control adjusts the VFO frequency, RIT offset (**RIT**, next page), keyer speed (**WPM**, next page), and is also used in the menu (page 66). Tapping the knob selects 100-Hz or 10-Hz VFO steps. Holding it for 0.5 seconds selects 1 kHz or 5 kHz VFO steps, depending on the receive mode (page 66). It is also used in along with other switches to activate certain advanced features.

Transmit frequency ranges: The KX1 transmits only in the ham bands (7.0-7.3, 10.10-10.15, and 14.0-14.35 MHz). Transmit will be prevented once you move a few kHz outside of each band, and you'll see **END** flashed on the display.

Potentiometers

RF GAIN: Sets the receive RF gain. Normally set fully clockwise, but can be rotated counter-clockwise to attenuate strong signals.

FILTER: Adjusts the receive crystal filter bandwidth over a range of about 300 to 2000 Hz. Narrow-bandwidth settings can be used to reduce interference from nearby signals when copying CW. Wider bandwidth settings are useful for copying SSB and AM.

AF GAIN: Sets the receive audio output level. The sidetone volume can be set higher or lower in relation to receiver audio using the **STL** menu entry (page 65).

POWER LEVEL (R4 - internal): This trimmer potentiometer is accessible through a hole in the bottom cover, and can be set using a small tuning tool or flat-blade screwdriver.



For best performance, keep R4 set fully clockwise, unless you must reduce power to conserve battery life. This control should not be adjusted frequently; trimmer potentiometers have a finite life (100-200 rotations).

Pushbutton Switch Functions

There are three small pushbutton switches below the display. A fourth pushbutton switch is built into the VFO knob.

TAP a switch to access its upper function (white label); **HOLD** a switch for 1/2 second to access its lower function (yellow label). Some switches can be held in combination as described at right.

Note: The **MENU**, **BAND**, and **RIT** switches can also be used at power-on to select maximum LED display brightness and turn on CW feedback on switch press at 10, 20, or 30 WPM (see page 67).

Switch **TAP** and **HOLD** Functions

MENU	Displays the menu (see next page)
EDIT	Edits current menu parameter
BAND	One tap shows frequency (MHz first, then kHz; L or U is added in LSB or USB modes). Two quick taps selects the next higher band.
WPM	Allows keyer speed adjustment using VFO control (8-50 WPM) without transmitting.
RIT	Turns RIT on/off. When RIT is on, the decimal point will flash slowly. The VFO knob will then vary <i>only</i> the receive frequency, in 20 Hz steps, +/- 5 kHz.
CLR	Zeros RIT offset When RIT is OFF, holding CLR for two seconds starts scanning (page 66).
10/100	Selects 10 or 100 Hz VFO steps
1 kHz	Selects 1 kHz VFO steps (5 kHz, USB/LSB modes)

Switch Combinations

MENU + **BAND** **TUNE:** Initiates TUNE mode (key-down)

Note: Limit TUNE time to 10 seconds on, 10 seconds off. If a KXAT1 ATU is installed, you'll see **ATU** for a few seconds during TUNE, followed by the power output (e.g. **P2.0**). Tapping any switch will cancel TUNE and flash the SWR (e.g. **r1.0**). If no ATU is installed, the display will show **tun**, since the KX1 itself does not include power metering. You'll still need to tap a switch or the keyer paddle to exit TUNE mode even in the non-ATU case.

BAND + **RIT** **DISP:** Selects display mode

Selects frequency (**nor**), S-meter (bargraph), or battery voltage (**BAT**) display mode. In **S-meter** mode, the frequency is re-displayed whenever the VFO is moved. S-meter mode functions as Frequency Announce mode if audible CW feedback is enabled (page 67). **Battery** display mode can be used during transmit or receive; in transmit mode, it overrides the bargraph or TUNE display.

The remaining switch combinations are described in the Advanced Operating Features section:

MENU + **RIT** CW/LSB/USB receive mode (page 66)

MENU + **10/100** Turns *Switch CW* on / off (page 68)

BAND + **10/100** High-Priority memory (page 67)

RIT + **10/100** Locks/unlocks VFO (page 68)

Menu Functions

To access the menu, tap **MENU**. You can then scroll through menu entries by rotating the VFO knob (see list below). Hold **EDIT** to display a menu entry's parameter, then change the parameter using the VFO knob. (Note: **PLY** and **RCL** behave differently: there is no need to enter edit mode to use them. See table for details.) Tap **MENU** to return to scrolling. Another tap of **MENU** will return you to normal operation. **Edit Shortcut:** You can skip tapping **MENU** and jump directly into editing the last-used menu entry by holding **EDIT**.

Menu Entry	Description	Usage Details
LED	LED Display Control	Tap BAND and RIT to select display brightness (0-5). VFO knob selects on-time (5 to 60 sec. in 5 sec. increments, or INF for <i>infinite</i>).
STL	Sidetone Level	There are four sidetone volume levels (0-3). AF GAIN also affects sidetone level.
STP	Sidetone Pitch	Pitch range is 500 to 700 Hz in 10 Hz steps. 600 Hz recommended to match BFO offset.
T-R	Transmit-Receive Delay	The T-R (QSK) delay can be set from 0 to 900 ms (20 ms recommended for casual operation).
RPT	Message Repeat Interval	Sets CW message auto-repeat interval (0 to 255 seconds). See page 66.
INP	Input Device Selection	Select Hnd (hand key or external keyer) or PDn / PDr (internal keyer, paddle norm./rev.). With PDn selected, J3 "tip" is DOT and "ring" is DASH. PDr is the reverse.
IAB	Iambic Mode	With a two-lever paddle (e.g. Elecraft KXPD1), you can use <i>iambic</i> keying; holding both paddles repeats a DOT-DASH or DASH-DOT pattern. This can improve sending efficiency. Mode A (default) has more forgiving timing and is similar to Curtis keyer IC mode A. Mode B is similar to Super CMOS Keyer III mode B.
CFB	CW Feedback Control	10-40 WPM or OFF . When CW feedback is on, audio Morse code is sent in response to all switch or menu activity, and S-meter mode provides freq. announcements during VFO movement (page 67).
SIG	S-Meter Scale and Zero Set	Zero parameter range is 30-99 , adjusted using VFO knob. Set for zero-bars indication in S-meter mode with no signal. Scale parameter range is 2-6 , adjusted by tapping BAND and RIT . With approx. S9+20 dB signal injected, adjust for 6 bars.
BFO	BFO Calibration	Sets BFO calibration offset, +/- 0.99 kHz. See page 68.
DDS	DDS Calibration	Sets DDS frequency reference scaling, +/- 99 PPM (parts per million). See page 68.
B30/B80	30/80 m Band Enable	Set to ON if KXB30 option is installed; covers 30 m and improves 49-m SWL reception (page 71). Tap 1 to select B30 , or 2 to select B80 . Set B30 to ON if either the KXB30 or KXB3080 option is installed. Set B80 to ON if the KXB3080 is installed. Otherwise both should be set to OFF .
BAT	Low-Battery Voltage Set	Sets the low-battery warning threshold voltage (see page 62 for recommendations).
ATU	ATU Mode	See KXAT1 manual. If the antenna tuner option is not installed, parameter appears as "---".
RCL/STO	Freq. Memory Recall/Store	To recall, tap 1 , 2 or 10/100 . To store, hold EDIT to switch to STO , then tap 1 , 2 or 10/100 . One memory can be assigned as the High-Priority memory for quick recall (see page 67).
PLY/REC	CW Message Play/Record	To play, tap 1 or 2 . To record, hold EDIT to switch to REC , then tap 1 or 2 . Auto-repeat: see page 66.

Advanced Operating Features

Recording and Playing CW Messages

The KX1 provides two message memories of 48 bytes each. *CW messages can only be recorded using the KX1's internal keyer.*

Set **INP** to **PDn** or **PDr** to use the internal keyer.

To Record: Tap **MENU** and locate the **PLY** menu entry, change it to **REC** by holding **EDIT**, then tap either **1** or **2**. The display will show **048**, indicating that 48 bytes of storage are available in this buffer. This number will count down toward 0 as long as you are sending. Whenever you stop sending completely, up to two standard-length word spaces will be inserted. To stop recording, tap any switch. If you do this *before* starting to send, the original message contents will be preserved.

To Play: Tap **MENU** and locate the **PLY** menu entry, then tap either **1** or **2**. Message play can be canceled at any time by hitting any key or by tapping the keyer paddle. You can also change the keyer speed while messages are playing using the VFO knob.

To use Auto-Repeat: Locate the **PLY** menu entry as before, but then *hold* either **1** or **2**. The message will then play back continuously until you tap another switch or hit your key or paddle. You'll see **RPT** on the display between message transmissions.

Setting the Auto-Repeat Interval: The length of the pause between messages during auto-repeat can be programmed using the **RPT** menu entry (**0-255** sec.). Long delays are useful for beacons.

Keyer Test Mode: To play back messages without transmitting, use keyer test mode. In this mode, you'll see **P=0** on the LED during message play, rather than the transmit bargraph. To turn keyer test mode on/off, locate the **PLY** menu entry, then tap the VFO knob. You'll see **P=0** and **nor** on alternate taps.

Receive Mode Selection (CW, LSB, USB)

The KX1 provides three receive modes: CW (**nor** or "normal"), **LSB**, and **USB**. Hold **MENU** + **RIT** to select the desired mode.

In **CW (nor)** receive mode, LSB is used on 40 meters, and USB is used on 30 and 20 meters. In this mode a CW offset is introduced on receive, which means that you must match received-signal pitch to your sidetone pitch to determine a station's carrier frequency. CW mode also provides a 1 kHz fast VFO tuning rate, compatible with ham-band tuning.

LSB and **USB** receive modes have no receive CW offset, so the VFO will show a station's carrier frequency when a voice signal is tuned in properly (SSB) or when a carrier is zero-beated (AM or CW). The required CW offset is instead introduced on transmit. These modes also provide a 5 kHz fast VFO tuning rate, useful for tuning SWL band segments.

Cross-mode (CW/SSB) operation: Cross-mode contacts can be made in all three of the KX1's receive modes, without the need to use RIT. When an SSB signal is correctly tuned in, and you transmit, the SSB station will hear you at about a 600-Hz pitch.

Receiver performance considerations: Several strong internally-generated signals can be heard outside of the ham bands⁷. If one of these signals falls near an AM signal of interest, try switching sidebands to reduce interference. **Note:** on 20 meters, **USB** and **nor** (CW) receive modes provide somewhat better sensitivity than **LSB** mode. See Circuit Details for an explanation.

⁷ These signals originate either at the DDS or from mixing products, and are typical for a superhet receiver using a low I.F. Strong signals appear at the following frequencies, in kHz, with the applicable sideband shown in parentheses: 5895 (USB), 6141 (USB), 6358 (LSB), 6550 (USB), 7989 (LSB), 9148 (both), 9826 (both), 14740 (both), 14981 (both). Additional weak signals can also be heard, but in general will be masked by band noise.

Scanning:

To set up scanning, use the **STO** menu function to save scan start/end points in frequency memories 1 and 2 (for each band). Now, whenever RIT is off, you can activate scanning by holding **CLR** for two seconds. Scanning is “live” (not muted). It can be stopped by tapping a switch, turning the VFO, or transmitting. If the VFO is set for 10 or 100 Hz steps, scanning proceeds at 100 Hz per step. If the VFO is set for fast tuning, scanning uses 1 kHz steps (if the receive mode is LSB or USB, 5 kHz steps are used outside ham bands).

Using Frequency Memories

Three frequency memories are available on each band, accessed using the **RCL** (recall) menu entry. In addition to VFO frequency, the receive mode (CW/LSB/USB) is saved on a per-memory basis.

Any one memory can be designated as **High-Priority** when it is stored, as described below. This allows you to quickly switch to one often-used memory—such as WWV or a net—and back.

To store: First tap **MENU** and scroll to the **RCL** menu entry (memory recall). Hold **EDIT** to change the menu entry to **STO** (store), then tap **1**, **2**, or **10/100** (VFO knob). The display will flash **1**, **2**, or **3** in response. However, if you *hold* rather than tap the switch that selects the memory, that memory will become the high-priority memory, and the display will instead flash **1H**, **2H**, or **3H**. Exit the menu.

To recall: Tap **MENU**, locate **RCL**, then tap **1**, **2**, or **10/100**. The recalled frequency and mode will be displayed. Exit the menu.

Switching to the High-Priority memory: First, press and hold **BAND** + **10/100**, which will switch to the high-priority memory, if one has been assigned. The stored receive mode will be used, and if the band changed, the ATU L/C values will also be recalled. If desired, you can then restore your original band and frequency by holding **BAND** + **10/100** again. Exception: If you tap **BAND** or change receive modes in the interim, the *restore* operation will be cancelled, and the KX1 will remain on the new band.

Audible CW Feedback on Switch Press

When CW feedback is turned on, audio Morse code will be sent in response to all KX1 controls, when using the menu, etc. This is useful when the display cannot be used, such as in very bright sunlight or when eyes-free operation is required. Speeds from 10 to 40 WPM can be selected, in 5-WPM steps.

To turn on CW feedback on switch press: Either (1) set the **CFB** menu parameter to the desired CW feedback speed; or (2) hold the **MENU**, **BAND**, or **RIT** switch down at power-on, which forces **CFB** to **10**, **20**, or **30** WPM respectively. This also sets the LED to maximum brightness and reports the firmware revision (on the display and in CW).

Differences between LED display and CW feedback:

1. All zeros are converted to long *T*'s, and decimal points are sent as *R* (a CW standard, derived from the word "radix"). In the **DDS** and **BFO** menu entries, the minus sign (-) is sent as *N*. For example, a BFO parameter of -.16 would be sent as *NR16*.
2. Some 3-letter text strings are reduced to a single letter. These include RIT on (R), RIT off (O), RIT clear (C), VFO lock (L), VFO unlock (U), nor/LSB/USB receive modes (N, L, U), and nor/announce/batt display modes (N, A, B). "Frequency Announce" display mode (A) is discussed below.
3. When using the menu, you can scroll quickly past menu entries if desired, which will truncate sending of associated text in CW. The **PLY** (Play) menu entry is truncated to *P*.
4. The VFO frequency can be checked at any time by tapping **BAND** once. The frequency will be announced in MHz and kHz, prefixed by U or L in USB or LSB mode, and followed by R if RIT is turned on. The kHz part of the frequency, and R for RIT if applicable, is also sent when you select the fast tuning rate.
5. **Frequency Announce** display mode provides audible "tics" every 10 VFO steps, and reports the kHz digits every 100 VFO steps (i.e., every 10 kHz if 100-Hz tuning is selected). This is useful for finding a specific frequency. The "tic" sound is a low tone, high

tone, or low/high tone (for 10 Hz, 100 Hz, and 1 or 5 kHz VFO steps, respectively). Frequency Announce mode is turned on in the same way as S-meter mode (hold the **DISP** switch combination, **BAND** + **RIT**). When you select announce mode, **AF** (for announce frequency) will be displayed, and the letter *A* will be sent in CW. Holding the **DISP** switch combination again will switch to battery display mode (B) and back to normal mode (N).

Switch CW: Sending CW using Front-Panel Switches

In an emergency, the **BAND** switch can be used as a hand key, or the **BAND** and **RIT** switches can be used as a keyer paddle. To enable this feature, first use the **INP** menu entry to specify hand key (**HND**) or one of the paddle modes (**PDn** / **PDr**). Next, press and hold the **MENU** switch and **10/100** simultaneously to toggle Switch CW on and off. You'll see **btn** ("button") when switch CW is on, and **Pdl** ("paddle") when it is off.

When switch CW is enabled and **INP** is set to **HND** (hand key), the normal functions of the **BAND** / **WPM** switch are not available. In addition, if **INP** is set to **PDn** or **PDr**, the functions of the **RIT** / **CLR** switch are not available. To use the normal functions of these switches, turn off Switch CW mode as described above.

VFO Lock/Unlock

Holding **RIT** + **10/100** locks (LOC) or unlocks (nor) the VFO knob. When the VFO is locked, rotating the knob will have no effect on the VFO frequency or **RIT** offset, and tapping or holding the knob will not change the tuning rate. The knob can still be used for changing the CW keying speed or accessing the menu.

Operating Frequency Calibration

The KX1's VFO display accuracy should be about +/- 200 Hz without calibration. Using the BFO and DDS calibration procedures below, you can improve accuracy to typically +/- 10 Hz.

Before calibration, the KX1 should be turned on and allowed to stabilize at room temperature for 15 minutes.

BFO Calibration: This procedure compensates for the difference between your BFO frequency and the nominal value (4913.00 kHz).

1. Select 40 or 30 meters, **LSB** receive mode.
2. In the menu, set **BFO** to **.00**, and **DDS** to **00**. Exit the menu.

Tune in a strong station at a known frequency as accurately as possible. You can zero-beat an unmodulated carrier (tune for 0 Hz audio pitch), or tune in an AM broadcast or reference station such as WWV. Write down the frequency shown on the dial.

4. Switch to USB, re-tune the signal, and write down this frequency.
5. Subtract the lower reading from the higher reading, then divide the result by two. Example: USB = 10000.10 kHz, LSB = 9999.90 kHz. Subtracting LSB from USB leaves 0.20 kHz, and dividing by 2 yields 0.10 kHz. This is the **BFO correction**.
6. If the LSB reading was the lower of the two, set the BFO menu parameter to the BFO correction value (in this example, **.10**). If the USB reading was the lower one, set the BFO parameter to the *negative* of the correction (in this example, **-.10**).
7. Exit the menu. You should now be able to switch between LSB and USB receive modes without re-tuning the VFO.

DDS Calibration: This procedure compensates for any error in the 50-MHz reference oscillator. The BFO calibration procedure, above, must be performed first.

1. Select 40 or 30 meters and **LSB** or **USB** receive mode. Don't use CW (**nor**) mode, as this introduces a receive offset.
2. Tune the VFO to the exact *specified* frequency of a reference signal. Example: For WWV at 10 MHz, you must tune to exactly 10000.00 kHz as indicated on the KX1's display. You might start with 5 kHz steps (hold the VFO knob), but then switch to 100 Hz and finally 10 Hz steps as you get closer (by tapping the knob).
3. Edit the **DDS** menu parameter. While listening to the reference signal, use the VFO knob to adjust the parameter so that the signal is properly tuned in. If it is an unmodulated carrier, tune for zero-

beat (0 Hz audio). If it's a voice signal, tune for most natural-sounding audio. Then exit the menu.

Checking the Firmware Revision

Hold any switch on power-up to display the revision (e.g. **1.01**).

Note: Checking the firmware revision by holding **MENU**, **BAND**, or **RIT** on power-up also sets the LED to high brightness and enables CW feedback on switch press (at 10, 20, and 30 WPM respectively). If you turn the KX1 back off before accessing the menu, the LED brightness and CW feedback will revert to their previous settings.

Resetting to Factory Defaults

Reset to defaults takes two steps. **Step 1:** Hold **BAND** and **MENU** together on power-up, releasing the switches after the LED test. You should see **E09**. **Step 2:** Turn power off and back on again; you should see **E10**. Tap any switch. You'll then need to set up all menu entries again.

QRP Operating Tips

Antennas: When you're using low power, a good antenna and ground system can make a big difference. There are many references on antennas available, including the *ARRL Antenna Handbook*.

QRP Frequencies: Low-power enthusiasts can be found at certain "watering hole" frequencies on each band, listed below (kHz). An asterisk (*) indicates European or alternative QRP frequencies.

80 m: 3560

40 m: 7040 (*7030)

30 m: 10106 (*10116)

20 m: 14060

Calling and Listening: Calling CQ with low power may be frustrating unless you have a very good antenna. Expect to spend far more time *listening*. Keep transmissions short, especially when working other QRP stations, which will often be at or even below the noise level. Narrower filters (less than 500 Hz) and slower code speeds (less than 20 WPM) should be used when conditions are marginal.

SWL (Shortwave Listening) Tips

Tuning Range: The KX1 can tune a wide range on each band:

80 m: 1-5.5 MHz

40 m: 5-9.5 MHz

30 m: 8-12.5 MHz

20 m: 12-16.5 MHz

The 80 meter and 30 meter frequencies are available when the optional KXB3080 (30 m and 80m) or the KXB30 (30 m only) modules are installed.

The useful tuning range is actually somewhat smaller, since signals will fall off as you tune outside the ham bands (note the exception to this described in the next paragraph).

Using the KXB30 or KXB3080 on 30 and 40 meters: If you have the KXB30 or KXB3080 option installed, you'll be able to use the associated ham bands and receive nearby SWL segments. But this option has another important function: its tuning capacitors will be turned on automatically on *40 meters* if you tune below 6.7 MHz. This re-resonates the band-pass filter at about 6.2 MHz, greatly improving sensitivity in the popular 49-meter SWL segment (5.9-6.4 MHz).

Tuning AM or SSB signals: The FILTER control should be set fully clockwise when listening to broadcast stations. While you can listen to AM or SSB stations in any of the KX1's three receive modes (CW/LSB/USB), LSB or USB provide two advantages: elimination of the CW receive offset, and 5 kHz rather than 1 kHz tuning steps. You can use 10-Hz steps to fine-tune (zero-beat) AM signals.

Frequency Memories and High-Priority Memory: Commonly-used SWL frequencies can be store in frequency memories. If you often switch to a time reference such as WWV (at 5, 10, or 15 MHz), you can designate the associated memory as high-priority for quick access (see page 67).

KX1 Options

30-Meter Module (KXB30)

The KXB30 adds 30 meter coverage to the KX1, and also greatly increases receive sensitivity in the 5.9-6.4 MHz SWL segment (with 40 m selected). 30 meters is an excellent band for day and night operation and is popular with QRPers. Being a WARC band, it is off-limits for contests, and is thus a haven for those not interested in contest operation. WWV or WWVH provide universal coordinated time announcements at 10.000 MHz, and many AM broadcast stations can be heard in the 9-10 MHz band.

The **B30** menu entry must be set to **ON** to use the 30-m band.

30 and 80-Meter Module (KXB3080)

The KXB3080 adds both 30 meter and 80 meter coverage to the KX1. Like the KXB30, the KXB3080 also greatly increases receive sensitivity in the 5.9-6.4 MHz SWL segment (with 40 m selected). When 80 m is selected, the tuning range is increased from 1.0 to 5.5 MHz.

The **B80** menu entry must be set to **ON** to enable both the 30 m and 80m bands when the KXB3080 module is installed.

Plug-In Keyer Paddle (KXPD1)

The KXPD1 paddle offers a rugged, lightweight alternative to traditional keyer paddles or hand keys. It plugs directly into the front of the KX1, and is ergonomically designed for operating comfort. The KXPD1 is retained by a thumb screw to prevent movement during keying, and can quickly be reversed for left- or right-handed operation.

Automatic Antenna Tuner (KXAT1)

With the KXAT1 internal automatic antenna tuner installed, you can connect unbalanced, random-length antennas directly to the KX1. (An inexpensive home-made balun can be used with balanced lines.) In many cases the ATU will provide a 2:1 or better match on all bands. Once you've tuned up an antenna, the tuner's L and C settings will be recalled instantly when the band is changed.

The KXAT1 provides SWR and power information for the KX1 display in TUNE mode. Also, during normal keying it provides an indication of power output on the LED bargraph (1 bar per 0.5 watts). Without the ATU installed, the KX1 displays **tun** in TUNE mode and 1 bar during keying.

Circuit Details

While reading this section, refer to the Block Diagram (Appendix C) and schematics (Appendix B).

Receiver: The receiver is a single-conversion superhet, using down-conversion to a low intermediate frequency (I.F.) of about 4.915 MHz. Down-conversion minimizes complexity and receive-chain noise, while the low I.F. allows adequate CW selectivity with a variable-passband, 3-pole crystal filter. The use of active mixers keeps current consumption low, compatible with portable operation.

DDS VFO: The VFO is based on a low-power DDS (direct digital synthesis) IC. A crystal oscillator provides the reference signal for the DDS, ensuring excellent frequency stability over a wide temperature range. While a DDS-based VFO does not offer the same signal purity as an L-C VFO or PLL synthesizer, it is a good choice for a portable station that will most often be used by a single operator well removed from strong nearby stations. It is also extremely frequency-agile, allowing coverage of both ham bands and SWL bands. The unit chosen (AD9834) requires a minimum of components and draws only 5 to 8 milliamps.

The DDS output is filtered by low-pass filter L4/L5/C50-52. In order to provide adequate roll-off of non-harmonic spurs about 14 MHz when operating at 40 meters, the filter's knee is set just above the 20-m band edge. Because of this, LSB receive mode on 20 meters is less sensitive; LSB on this band requires a mixer injection frequency of $4.9+14 = 18.9$ MHz, which is significantly attenuated by the DDS filter.

Transmitter: On transmit, the DDS outputs the actual carrier frequency, so no transmit mixer stage is required. Q1, Q4 and Q5 form a 3-stage buffer for the DDS signal. Maximum power output from the final stage (Q6) is about 4 to 5 watts, depending on the supply voltage. Q7, in the receive band-pass filter, limits the signal voltage that can reach the receive mixer when the rig is in transmit mode.

Microcontroller: A low-power microcontroller (U1, MCU) is used to control the transceiver and handle user interface elements, such as the display and switches. The MCU communicates with the optional KXAT1 ATU on the VFWD/DATA line at about a 2 kHz data rate. U1 runs at just below 4 MHz to avoid band-edge spurs.

The KXAT1 provides SWR and power information for the KX1 display in TUNE mode. During normal keying, it provides an accurate indication of power output (1 bar per 0.5 watts). Without the ATU installed, the KX1 displays only a qualitative power output indication (see page 64).

Appendix A - KX1 Parts List



Many parts are static-sensitive, including parts pre-mounted on the circuit board. Wear a grounded wrist strap or ground yourself frequently while handling. Do not handle more than necessary. Do not remove parts with leads in black foam from the foam until they are installed.

Photo	Reference Designator	Description	Quan.	Part No.
	C5,C8,C11,C12,C16,C17, C18,C21,C31,C39,C43	Capacitor, 0.1 μ F, 0.1" LS (104)	11	E530020
	C3,C6,C9,C15,C22,C30, C32,C33,C34,C37,C41, C42,C55	Capacitor, .01 μ F, 0.1" LS (103)	13	E530019
	C48, C49	Capacitor, 1000 pF C0G, 5%, 50 V, 0.1" LS (102)	2	E530072
	C46	Capacitor, 470 pF C0G, 5%, 50 V, 0.1" LS (471)	1	E530004
	C14	Capacitor, 330 pF, C0G, 5%, 50 V, 0.1" LS (331)	1	E530147
	C47	Capacitor, 220 pF C0G, 5%, 50 V, 0.1" LS (221)	1	E530042
	C27	Capacitor, 150 pF C0G, 5%, 50 V, 0.1" LS (151)	1	E530049
	C51	Capacitor, 100 pF, C0G 5%, 50 V, 0.2" LS (101)	1	E530034
	C45	Capacitor, 68 pF, C0G, 5%, 50 V, 0.2" LS (68, 680) Note: C56 is also 68 pF, but has 0.1" lead spacing.	1	E530007
	C56	Capacitor, 68 pF, C0G, 5%, 50 V, 0.1" LS (68, 680)	1	E530150
	C13, C54	Capacitor, 56 pF, C0G, 5%, 50 V, 0.1" LS (56, 560)	2	E530146
	C50	Capacitor, 39 pF, C0G, 5%, 50 V, 0.2" LS (390, 39)	1	E530036
	C2, C4, C24, C25	Capacitor, 27 pF C0G, 5%, 50 V, 0.1" LS (27, 270)	4	E530141
	C52	Capacitor, 22 pF C0G, 5%, 50 V, 0.1" LS (22, 220)	1	E530017
	C1	Capacitor, 4.7 or 5 pF C0G, 5%, 50 V, 0.1" LS (4.7)	1	E530048









Photo	Reference Designator	Description	Quan.	Part No.
	C26	Capacitor, 120 pF disc (121)	1	E530041
	C19, C44	Capacitor, .022 μ F, 50 V (223)	2	E530056
	C7	Capacitor, 220 μ F electrolytic	1	E530046
	C23,C35	Capacitor, 100 μ F electrolytic, low-profile	2	E530149
	C10,C20,C38,C53	Capacitor, 10 μ F electrolytic, low-profile	4	E530045
	CA,CB	Capacitor, trimmer, 5-20 pF, bottom adjust (red)	2	E540004
	CC	Capacitor, trimmer, 8-50 pF, bottom adjust (brown)	1	E540005
	D1	LED, White, T1-3/4 size	1	E570014
	D2, D3	Diode, Shottky, 1N5817	2	E560008
	D5, D6	Diode, varactor, 1SV149	2	E560005
	D4	Diode, switching, 1N4148	1	E560002
	D7	Diode, 47 V zener, 1N4756A	1	E560013
	DS1	LED display, 3 digit, 7 segment	1	E570013







Photo	Reference Designator	Description	Quan.	Part No.
	J1	Conn., DC barrel	1	E620026
	MISC	Mating connector for J1	1	E620032
	J2	Conn., BNC, R.A. PCB mount, no bushing	1	E620075
	J3	Conn., 1/8" stereo jack	1	E620027
	MISC	Miniature three-circuit plug that mates with J3	1	E620033
	J4	Conn., 1/8" stereo jack with switch	1	E620028
	J5	Conn., 2-pin female housing, 0.1" spacing, for internal battery	1	E620021







Photo	Reference Designator	Description	Quan.	Part No.
	MISC	Crimp pins for J5, package of 2	2	E620022
	J6	Conn., 5-pin female, 0.1" spacing	1	E620051
	J7	Conn., 3-pin female, 0.1" spacing	1	E620009
	J8	Conn., 2-pin female, 0.1" spacing	1	E620066
	K1,K2	Relay, DPDT	2	E640010
	L1,L2	Toroid on T37-6 core (Yellow): #26 enamel; L1 13t; L2 14t (See text for winding instructions)	2	E680013
	L3	Inductor on FT37-43 core (Black): 6T #26 (See text for winding instructions)	1	E680003
	T1	Transformer wound on FT37-43 core (Black), 8T:2T #26 (See text for winding instructions)	1	E680003
 Do not mix these with resistors. Keep them in their own envelope until installed.	L6	mini (larger size) RF choke, 6.8 μ H (blu-gry-gld) Note: L6 may be physically larger than L7 in some kits. This is normal.	1	E690044
	L7	mini (larger size) RF choke, 4.7 μ H (yel-vio-gold)	1	E690042
	L4	micro (smaller size) RF choke, 2.2 μ H (red-red-gold)	1	E690036



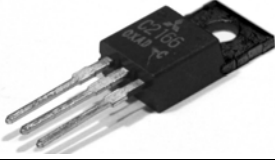

Photo	Reference Designator	Description	Quan.	Part No.
	L5	mini (larger size) RF choke, 5.6 μ H (grn-blu-gold)	1	E690037
	L8	micro (smaller size) RF choke, 18 μ H (brn-gry-blk)	1	E690040
	L9	micro (smaller size) RF choke, 100 μ H (brn-blk-brn)	1	E690013
	L10	micro (smaller size) or mini (larger size) RF choke, 33 μ H (org-org-blk) Note: When color coded, either or both orange bands may appear to be brown.	1	E690041
	P1	Connector, 2-pin male with locking ramp, 0.1" spacing, for internal battery	1	E620024
	Q1, Q2, Q3	Transistor, JFET, J309 (309)	3	E580009
	Q4, Q7, Q8, Q9	Transistor, NPN, 2N4124	4	E580006
	Q5	Transistor, NPN, 2N3904	1	E580017
	Q6	Transistor, NPN power 2SC5739 (plastic tab) or 2SC2166 (metal tab)	1	E580007
	R1,R3	Pot, 1K linear, panel mount, no bushing	2	E520013
	R2	Pot, 10K linear, panel mount, no bushing	1	E520014



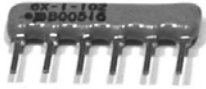

Photo	Reference Designator	Description	Quan.	Part No.
	R4	Pot, 100 ohm trimmer	1	E520008
	R18	Resistor, 3.3M, 1/4 watt, 5% (org-org-grn)	1	E500021
	R15	Resistor, 1M, 1/4 watt, 5% (brn-blk-grn)	1	E500024
	R13,R24,R29,R32	Resistor, 22K, 1/4 watt, 5% (red-red-org)	4	E500090
	R8,R12	Resistor, 6.8K, 1/4 watt, 5% (blu-gry-red)	2	E500115
	R5	Resistor, 4.7K, 1/4 watt, 5% (yel-vio-red)	1	E500047
	R21	Resistor, 2.7K, 1/4 watt, 5% (red-vio-red)	1	E500005
	R19, R28	Resistor, 1.8K, 1/4 watt, 5% (brn-gry-red)	2	E500004
	R16,R17,R20,R31	Resistor, 1K, 1/4 watt, 5% (brn-blk-red)	4	E500013
	R23	Resistor, 470 ohms, 1/4 watt, 5% (yel-vio-brn)	1	E500003
	R9,R22	Resistor, 300, 1/4 watt, 5% (org-blk-brn)	2	E500023
	R6,R7	Resistor, 200 ohms, 1/8 watt, 5% (red-blk-brn)	2	E500114
	R10,R14,	Resistor, 47, 1/4 watt, 5% (yel-vio-blk)	2	E500019
	R26,R27, R30	Resistor, 22, 1/4 watt, 5% (red-red-blk)	3	E500028
	R11,R25	Resistor, 10 ohms, 1/4 watt, 5% (brn-blk-blk)	2	E500054
	RP1	Rpack, 390 ohms, 8R, 16 pins (391)	1	E510023
	RP2	Rpack, 1K, 5R, 6 pins (102)	1	E510024
	RP3,RP4	Rpack, 10K, 5R, 10 pins (103)	2	E510025
	RP5	Rpack, 100K 5R, 10 pins (104)	1	E510026





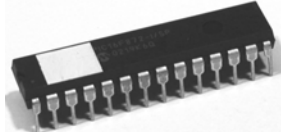

Photo	Reference Designator	Description	Quan.	Part No.
	S1,S2	Slide Switch, SPDT, PCB mount, 0.5A @ 50V	2	E640015
	S3,S4,S5	Momentary contact. switch, 6mm	3	E640016
	MISC	Keycap, square, blue, 6 mm	3	E640017
 Handle with care - ESD Sensitive. 	U1	IC, MCU, KX1, PIC16F876A (E600075)	1	E610017
Pre-installed on board	U2	IC, DDS, AD9834, SMD	1	E600076
 Handle with care - ESD Sensitive.	U3	IC, TC4427, dual driver	1	E600077
	U4	IC, LM386N-1, AF amp	1	E600022



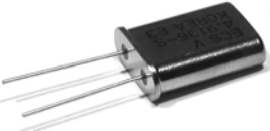

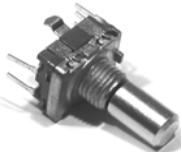

Photo	Reference Designator	Description	Quan.	Part No.
	U5,U6	IC, NE602 or NE612 mixer	2	E600006
Pre-installed on board	U7	IC, TPS76427, 2.7V reg, 5-PIN, SMD	1	E600078
 Handle with care - ESD Sensitive.	U8	IC, 78L05, 5-V regulator	1	E600029
		U9	IC, 77L06, Low dropout 6-V regulator	1
	X2-X5	Crystals, 4.9136 MHz, matched set of 4 (using p/n E660000)	4	E850162
	X1	Crystal, 3.995 MHz, low profile, HC49/US	1	E660020
	Z1	Encoder, 80 Counts, w/PB switch	1	E640018
Pre-Installed on Board	Z2	Oscillator module, 50 MHz, SMD	1	E660021
	HDWR	Shoulder washer	1	E700001

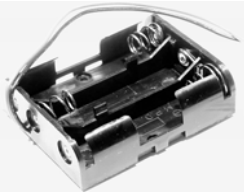

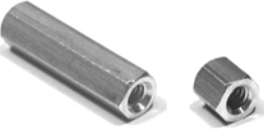



Photo	Reference Designator	Description	Quan.	Part No.
	MISC	Battery holder, 3 AA cells	2	E980071
	HDWR	Screw, 2-56 x 1/8" Panhead Phillips, black (2 spares)	6	E700084
	HDWR	Standoff, 4-40 x 5/16" long, 3/16" dia., hex, Male-Female	2	E700083
	HDWR	Standoff, 4-40 x 3/16" long, 3/16" dia., hex,	1	E700068
	HDWR	Standoff, 4-40 x 3/4" long, 3/16" dia., hex	2	E700085
	HDWR	Split lock washer, #4 (2 spares)	6	E700004
	HDWR	4-40 x 5/16" thumbscrew, black oxide	2	E700050
	HDWR	Screw, 4-40 x 1/4" undercut flat-head Phillips, black (2 spares) Note: If your kit has a 2SC2166 (metal tab) for Q6, one screw will be nylon (part number E700092). Use the nylon screw for mounting Q6 as described in the assembly procedure.	5	E700082









Photo	Reference Designator	Description	Quan.	Part No.
	HDWR	Screw, 4-40 x 3/16" pan-head Phillips, black	1	E700015
	MISC	Rubber foot, self-adhesive	3	E700024
	MISC	KX1 top cover	1	E100172
	MISC	KX1 bottom cover	1	E100173
	MISC	Wire, #26 red enamel	6' (1.8m)	E760002
	MISC	Wire, #26 green enamel	3' (0.9m)	E760004
	MISC	Knob, 1.15" dia.	1	E980072
	MISC	Red plastic filter w/two adhesive strips (Packaged with serial number label and thermal pad in a small envelope).	1	E980073
	MISC	IC socket, ultra-low-profile, 28 pins	1	E620074

Photo	Reference Designator	Description	Quan.	Part No.
	MISC	Large Allen wrench, MSC 05471057 5/64"	1	E980004
	MISC	Sandpaper	1	E850090
 Handle with care - ESD Sensitive. 	MISC	KX1 PCB w/pre-mounted parts (U2, U7, Z2); Empty PCB is Part No. E100174	1	E850163
	MISC	Thermal pad (Normally shipped in the same envelope with the Serial Number label).	1	E700002
	MISC	Heat-shrink tubing	6" (15.3 cm)	E980037
	MISC	Serial number label	1	E980024



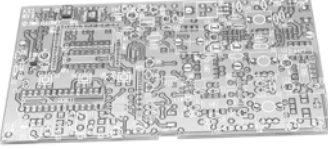
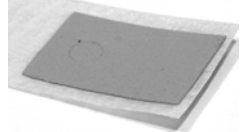
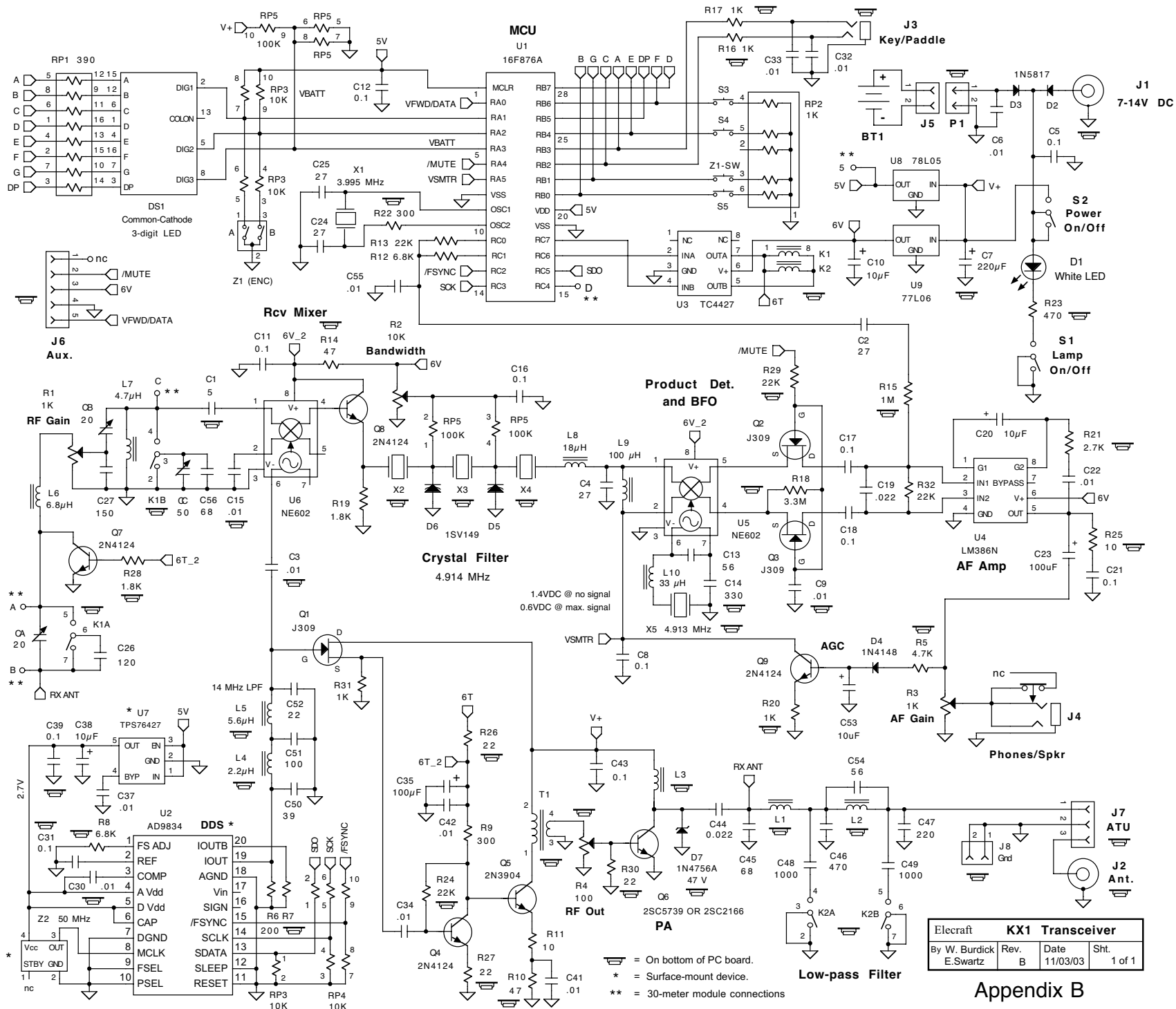
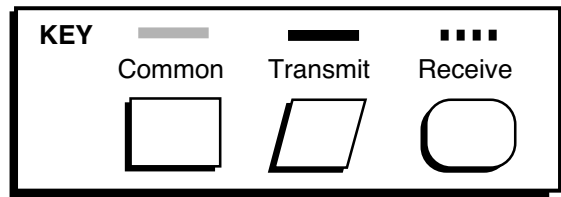
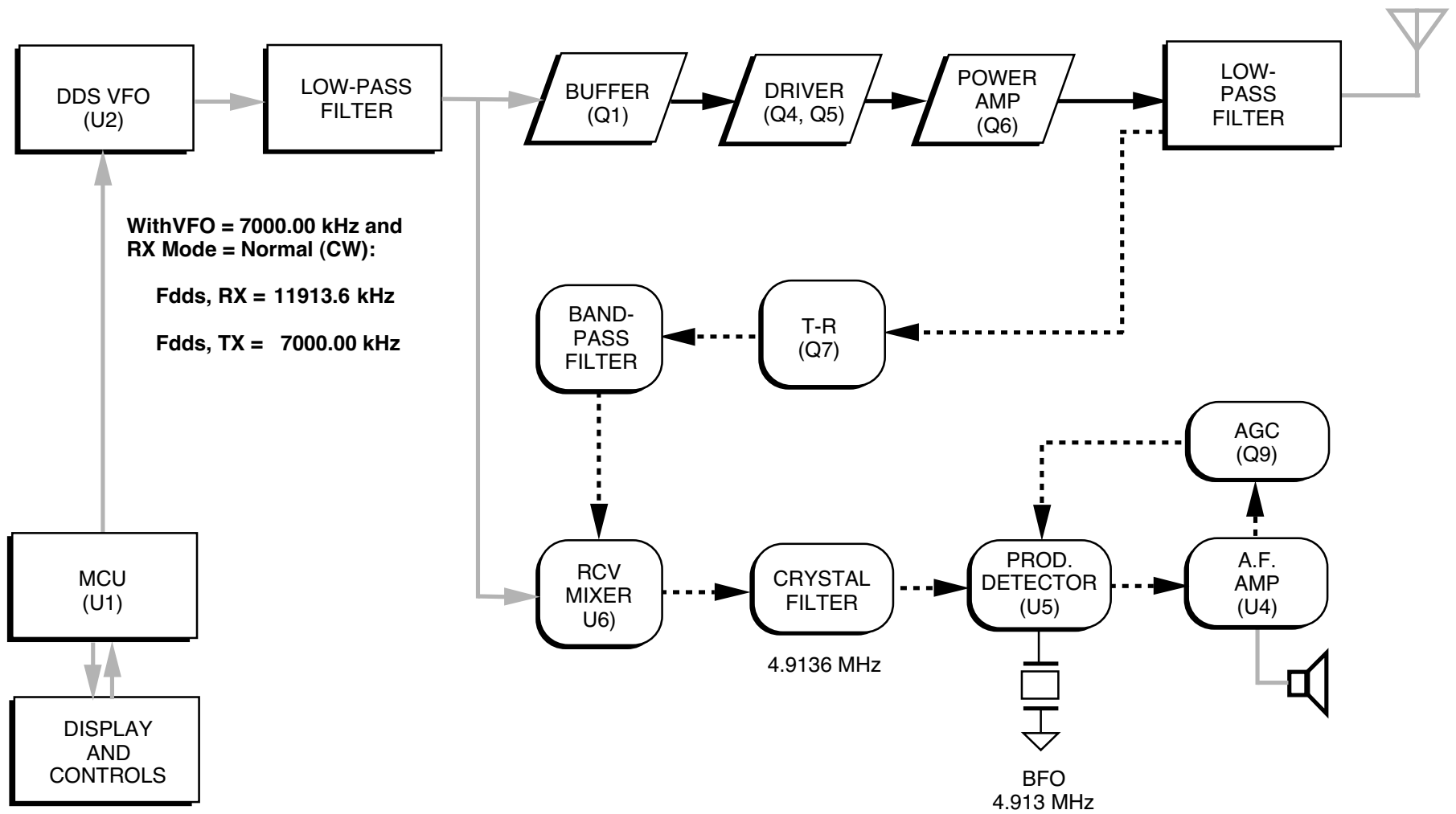

Appendix C KX1 BLOCK DIAGRAM
 W. Burdick/E. Swartz Rev. A 10-04-00

Appendix D. KX1 Assembly Photographs

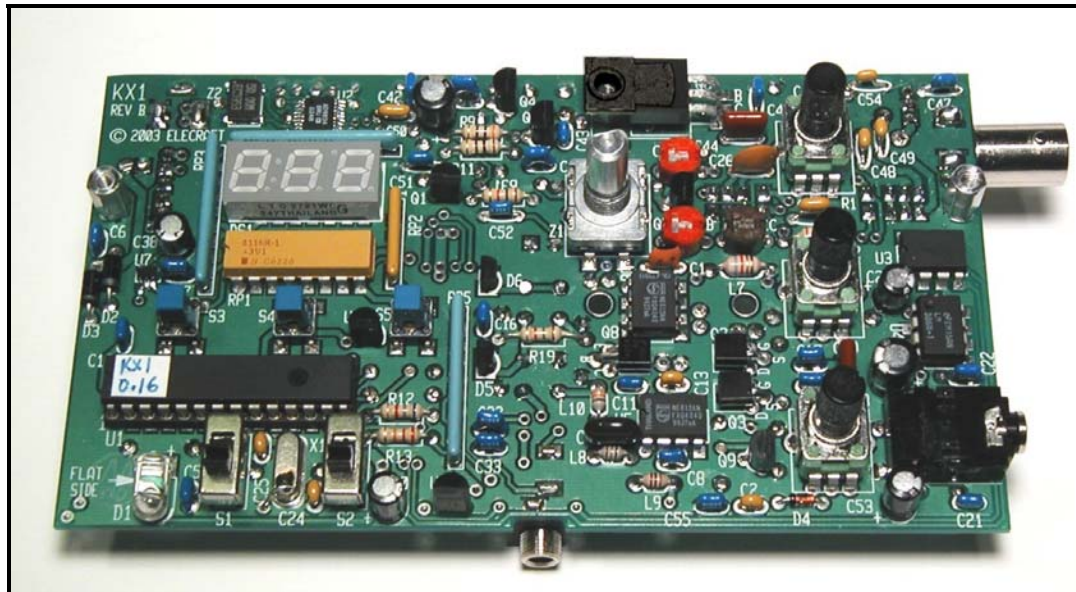

Assembled PC board, top view

NOTE: The power transistor near the center at the top edge may have a black plastic or shiny metal tab.

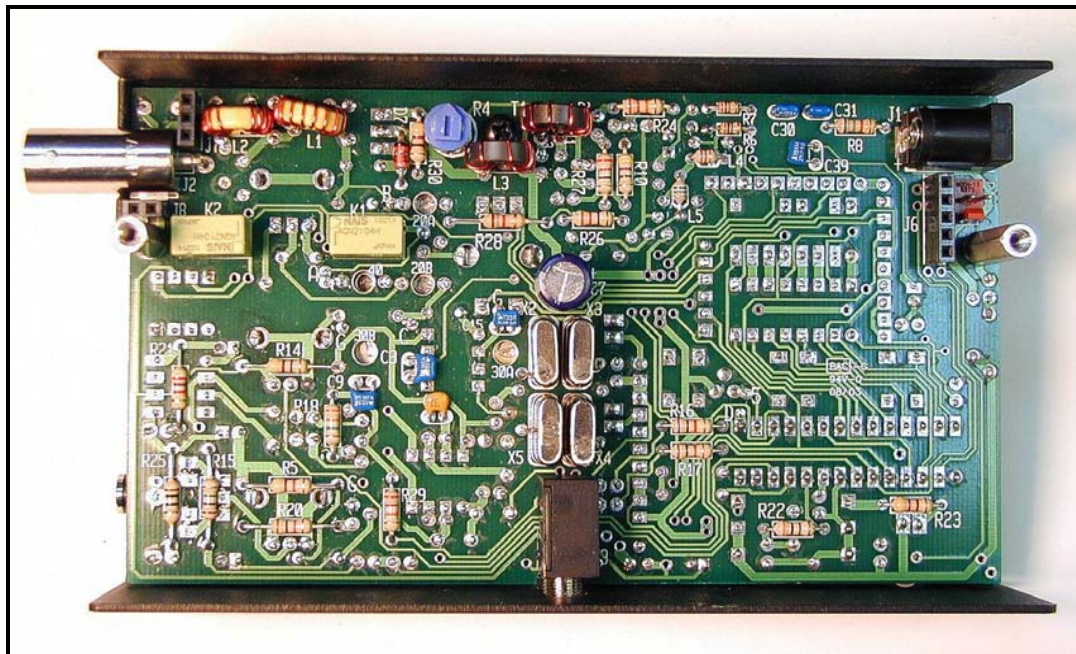

Assembled PC board, bottom view, with top cover installed

Appendix E - Troubleshooting

KXI TOP COVER REMOVAL: (1) Remove the three flat-head screws that hold the PCB to the top cover. (2) remove the VFO knob. (3) Flex the front edge of the top cover outward slightly while pulling upward gently on the key jack. The key jack should pop out of its hole. (3) Lift out the PCB.

(!) NOTE: If you need to transmit with the top cover removed, Q6 will not have a heatsink. Turn the power control (R4) fully counter-clockwise to limit power to 0.5 watt or less. To prevent damage to the PA transistor, limit transmit time to 3 seconds keydown, 10 seconds key up.

KXI TOP COVER INSTALLATION: (1) Place the top cover onto the PC board. Align switch caps with their holes using a long tool inserted between PCB and top cover. (2) Snap the key jack into its hole by pushing down gently. (3) Secure the PCB to the top cover using three 4-40 x 1/4" flat-head screws. (4) Install the VFO knob.

General Troubleshooting Procedure

- Look for your problem in the **Troubleshooting Tables**.
- Closely examine PC boards for poor solder joints and incorrect, broken or missing components.
- Check voltages using the **DC Voltage Table** at the end of this section.

Error Messages

If you see a message such as **E10** on the LED, look up the corresponding entry in the Troubleshooting Tables. Error messages can usually be cleared by pressing any switch. However, the cause of the message should be investigated before continuing to operate the transceiver.

Troubleshooting Tables

There are five troubleshooting tables (listed below). Within each table, problems are identified by 2-digit numbers for cross-referencing purposes. In most cases you'll know which table to look in based on the symptoms you observe. If in doubt, start with the General Troubleshooting table. Some problem identifiers have corresponding **error messages** (see above).

General Troubleshooting	00-19
Display and Control Circuits	20-39
VFO	40-59
Receiver	60-79
Transmitter and Keyer	80-99

General Troubleshooting (00-19)

Problem	Troubleshooting Steps
00 Unit appears to be completely dead when power switch is turned on (no display, no audio); possible smoke, hot components, etc.	<ul style="list-style-type: none"> ▪ Make sure your power supply is connected, turned on, and not plugged in backwards ▪ Check fuses; examine cables for open/short ▪ If the top cover is removed, make sure you don't have a screw inserted into the tab of the PA transistor (Q6)—this will short the 12V line ▪ Measure the +6V and +5V regulated power supply voltages (20) ▪ Check the MCU, U1 (26)
01 LED problem	<ul style="list-style-type: none"> ▪ See control circuits (24)
02 BAT LO displayed	<ul style="list-style-type: none"> ▪ Battery voltage may be below the level set in the BAT menu entry. Recharge the battery as soon as possible.

03 No audio	<ul style="list-style-type: none"> See Receiver troubleshooting table (60)
05 Current drain is excessive on receive	<ul style="list-style-type: none"> Check regulated voltages (20); look for a component that's warm to the touch
06 Supply voltage drops when KX1 is on	<ul style="list-style-type: none"> Check receive-mode current drain (05) Battery not fully charged
07 Error in actual vs. displayed frequency	<ul style="list-style-type: none"> See Operation section (CAL menu entry)
08 Freq. drift or instability	<ul style="list-style-type: none"> See VFO troubleshooting table (40)
09 EEPROM initialization pending	<ul style="list-style-type: none"> E09 on display: See Advanced Operating Features, <i>Resetting to Factory Defaults</i>
10 EEPROM was just initialized	<ul style="list-style-type: none"> You may see E10 one time on power-up, or if you install a new version of the firmware. All KX1 parameters are set to defaults.
15 END or P=0 is displayed on keydown	<ul style="list-style-type: none"> END: TX out of range (see specifications) P=0: CW test mode (see PLY menu entry)

Display and Control Circuits (20-39)

Problem	Troubleshooting Steps
20 Regulated voltage(s) incorrect	<ul style="list-style-type: none"> DC input voltage must be > 6.5V Unplug KXAT1 ATU option and re-check If +6V is too low (< 5.7V) go to 22 If +5V is too low (< 4.7V) go to 23 If +2.7V is too low (< 2.5V) go to 23
21 General problem with switches or potentiometers	<ul style="list-style-type: none"> Check switch resistance open/closed; RP2 may be in backwards Check resistance of potentiometers
22 +6 V too low (< 5.7V)	<ul style="list-style-type: none"> Remove KXAT1 ATU option and re-check Inspect 6V path on the KX1 PC board Check for U9 installed backwards Lift other component leads on the 6V line as needed to find cause of excess loading
23 +5V too low (< 4.7V) or +2.7V too low (< 2.5V)	<ul style="list-style-type: none"> Remove U1 from its socket Check for U8 installed backwards Check for U7 incorrectly installed (surface mount--use magnifying glass) Use techniques given for 6V regulator (above)

24 LED display problem	<ul style="list-style-type: none"> DS1 backwards; check for shorts to ground on each pin MCU pin bent or broken (U1) RP1 pin not soldered or shorted
25 Relay Problem	<ul style="list-style-type: none"> Relays not soldered Check relay coil resistance, pins 1 and 8 U3 (TC4427) defective or backwards (27)
26 Possible MCU problem	<ul style="list-style-type: none"> Check all DC voltages on U1 Make sure U1 is not backwards, has no bent pins, and is seated firmly in its socket. Check oscillator components (X1, C24, C25, R22) Also see (33) if you suspect an error in a menu parameter, etc.
29 AuxBus problem (no communication with KXAT1 ATU)	<ul style="list-style-type: none"> Look for short at J6 pin 5, U1 pin 2, or KXAT1-U1 pin 17 Check voltage on J6 pin 5 (see table)
30 EEPROM test #1 failed 31 EEPROM test #2 failed 32 EEPROM data error	<ul style="list-style-type: none"> If you E30, E31 or E32 on the LED, one of the EEPROM tests has failed. CW memories cannot be used. Parameters will be set to defaults, and band 1 will be selected. Try a full reset (33) U1 may be damaged or inserted backwards
33 Configuration data or menu problem	<ul style="list-style-type: none"> If a menu parameter is out of range or can't be modified, EEPROM may need to be reinitialized. See Advanced Operating Features

VFO (40-59)

Problem	Troubleshooting Steps
40 General VFO (DDS) problem; frequency jumps or drifts	<ul style="list-style-type: none"> ▪ Note: A small amount of DDS drift may occur due to aging of components and heating/cooling of the cabinet ▪ Check 14 MHz LPF components (L4, L5, C50-C52) and buffer (Q1, R31) ▪ Make sure supply voltage is above 6.5V ▪ Check values of R8, R6, R7, RP4, RP3 ▪ Check 5V and 2.7V regulator output (23) ▪ Check installation of Z2 and U2 (both surface mount--use magnifying glass)
41 Can't tune VFO (or RIT offset)	<ul style="list-style-type: none"> ▪ VFO may be locked (see Operation) ▪ VFO or RIT offset may be at end of range ▪ See 40, above
42 No DDS output	<ul style="list-style-type: none"> ▪ See 40

Receiver (60-79)

Problem	Troubleshooting Steps
60 Low (or no) audio output from receiver, or general receiver gain problem	<ul style="list-style-type: none"> ▪ If you hear normal audio output on one band but not all bands, see 62 ▪ Make sure you have headphones or speaker connected; turn AF GAIN clockwise ▪ Check the key jack for a short to ground ▪ Make sure RF GAIN is fully clockwise ▪ Re-peak the band-pass filters ▪ Check for ground shorts in the LPF and BPF ▪ If you don't hear any "hiss" at the receiver output, troubleshoot the AF amplifier (65) ▪ Check the 6V regulator (20)
62 Signal loss only on one band	<ul style="list-style-type: none"> ▪ Re-do alignment on affected band ▪ Check the band-pass and low-pass filters and crystal for this band ▪ Check functioning of the relays (change bands, then measure relay leads that should be open or shorted for that band)

65 AF amplifier not working	<ul style="list-style-type: none"> ▪ Use the STL menu entry to set a sidetone level of 3. If you hear a strong tone, the A.F. amplifier (RF-U4) is probably working, and the problem is likely to be with the mixer (RF-U6) or other RF board circuits. ▪ Signal trace through the receive chain backwards by touching a tool or wire to various points along the receive path ▪ Check all DC voltages in the receiver ▪ Inspect the A.F. amp circuits
70 AGC or S-meter not working	<ul style="list-style-type: none"> ▪ Check R5, D4, C53, Q9, R20, C8, and L9 for incorrect values or unsoldered leads

Transmitter and Keyer (80-99)

Problem	Troubleshooting Steps
80 General Transmitter problem	<ul style="list-style-type: none"> ▪ If power output is too low, go to 86 ▪ If power output slowly increases during key-down, go to 88 ▪ If current drain on transmit is too high for the given power level, go to 92 ▪ If the transmitter output power seems to be unstable go to 88 ▪ If the transmitter stops transmitting by itself go to 90 ▪ If the keyer isn't working properly, go to 95
86 Power output is low or zero	<ul style="list-style-type: none"> ▪ Make sure the power-output control, R4, is set fully clockwise ▪ If the top cover is removed, make sure you don't have a screw inserted into the tab of Q6 ▪ Unplug the ATU (KXAT1) and insert a jumper between pins 1 and 3 of J7; connect a dummy load at J2. If this solves the problem, see the KXAT1 manual's troubleshooting section. ▪ Check power output when using a 50Ω dummy load; if the output is correct on a dummy load but not when using an antenna, your antenna is probably not matched ▪ You may have a short in the LPF or BPF or

	<p>an incorrect LPF component value</p> <ul style="list-style-type: none"> ▪ Check relays (25) ▪ Examine T1, L3, L1, and L2 for poorly-stripped leads ▪ Check T1 for backward windings ▪ Check all DC voltages in the transmitter (Q1, Q4, Q5, Q6) ▪ Signal-trace through the transmitter to find where signal is lost (using an RF probe) ▪ Check for any components getting hot
--	------------------------------------------------------------------------------------------------------------------------------------------------------------------------------------------------------------------------------------------------------------------------------------------------------------------------------------------------------------------------------------------------------------------------------------------------------

88 Power output fluctuates	<ul style="list-style-type: none"> ▪ If you stay in key-down (TUNE) mode for several seconds, it is normal to see some increase in power; this is due heating of the final amplifier transistor. ▪ If power goes up and down significantly during normal keying, you may have a poorly-matched antenna OR you may have power set too high for your battery or power supply to handle; try reducing power or replacing batteries ▪ If the transmitter is unstable (oscillating) even when connected to a 50-Ω load, you may have an incorrect component value or a toroid-winding error (86)
90 Output power drops to zero suddenly	<ul style="list-style-type: none"> ▪ If you have transmit power set too high for your battery or power supply, the supply voltage may drop so low on transmit that it resets the MCU (U1); try a higher supply voltage or fresh batteries ▪ If there's no ATU installed, verify that J7 (ATU connector) is bypassed with a jumper between pins 1 and 3
92 Current drain too high on transmit	<ul style="list-style-type: none"> ▪ You may have power set higher than the final amplifier can achieve for a given load or power supply voltage, resulting in overdrive of transmitter stages. Reduce power to see if normal current drain is restored. ▪ Damaged PA transistors or other components could cause inefficiency in any stage of the transmitter. Check all DC voltages and components; signal trace if necessarily (86)
95 Keyer Problem	<ul style="list-style-type: none"> ▪ If the keyer is generally erratic when transmitting and seems to get worse as power is increased, you probably have RF leaking into the keyline. Try bypassing your key with .001 μF capacitors; also try 100 μH RF chokes in series with the paddle connections. ▪ Seek a better antenna match ▪ Improve your ground system

DC Voltage Table – Integrated Circuits

NOTES: Measurements were made with a 50-ohm dummy load connected and a supply voltage of 13 V. The 30- meter option was installed (KXB30) and the ATU was removed (KXAT1). In general, your measurements should be within 10% of the values shown. **Pins NOT listed in the table should indicate 0.0 volts DC. Pins marked with (*) are hard to measure due to noise pickup. Shaded areas show transmit-mode measurements (using TUNE).**

Ref.	Pin	VDC	Ref.	Pin	VDC	Ref.	Pin	VDC	Ref.	Pin	VDC	Ref.	Pin	VDC
U1	1	5.0	U1	18	0.0	U2	7	0.0	U3	4	0.0	U5	5	4.44
	2	5.0		19	0.0		8	1.32		5	0.0		6	5.57
	3	4.6		20	5.0		9	0.0		6	5.9		7	4.95
	4	4.9		21	5.0		10	0.0		7	5.9		8	5.62
	5	4.9		22	5.0		11	0.0		8	n/c	U6	1	1.39
	6	3.4		23	4.9		12	0.0	U4	1	1.26		2	1.39
	7	1.4		24	5.0		13	0.0		2	0.0		3	0.0
	8	0.0		25	5.0		14	0.0		3	0.0		4	4.39
	9	0.8		26	4.7		15	2.5		4	0.0		5	4.47
	10	0.9		27	5.0		16	n/c		5	2.97		6	5.54
	11	0.0		28	5.0		17	n/c		6	5.93		7	5.04
	12	0.0	U2	1	1.15		18	0.0	(n/c)	7	2.99		8	5.62
	13	5.0		2	1.18		19	0.32		8	1.26	U7	1	5.0
	14	0.0		3	1.41		20	0.32	U5	1	1.39		2	0.0
	15	0.0		4	2.69	U3	1	n/c		2	1.39		3	5.0
	16	0.0		5	2.69		2	0.0		3	0.0		4	1.17
	17	0.0		6	2.69		3	0.0		4	4.44		5	2.69

DC Voltage Table – Transistors and Diodes

NOTES: Measurements were made with a 50-ohm dummy load connected and a supply voltage of 13 V. The 30- meter option was installed (KXB30) and the ATU was removed (KXAT1). In general, your measurements should be within 10% of the values shown. **Pins NOT listed in the table should indicate 0.0 volts DC. Pins marked with (*) are hard to measure due to noise pickup. Shaded areas show transmit-mode measurements (using TUNE).**

Ref.	Pin	VDC	Ref.	Pin	VDC	Ref.	Pin	VDC	Ref.	Pin	VDC	Ref.	Pin	VDC
D1	A	13.33	Q1	D	13.5	Q7	B	0.7						
(on)	K	10.4		G	0.34		C	*						
D2	A	13.8		S	1.77	Q8	B	4.39						
	K	13.5	Q2	D	4.44		C	5.61						
D3	A	9.0		G	3.44		E	3.74						
	K	13.5		S	4.44	Q9	B	0.3*						
D4	K	0.3*	Q3	D	4.45		C	1.39						
D5	K	5.8		G	3.44		E	0*						
D6	K	5.8		S	4.45									
D7	K	13.5	Q4	E	0.23									
				B	0.94									
				C	2.14									
			Q5	E	2.24									
				B	2.14									
				C	13.5									
			Q6	C	13.5									

Appendix F Parts Placement Drawing (Top)

(Includes KXPD1, KXB30, and KXAT1 boards)

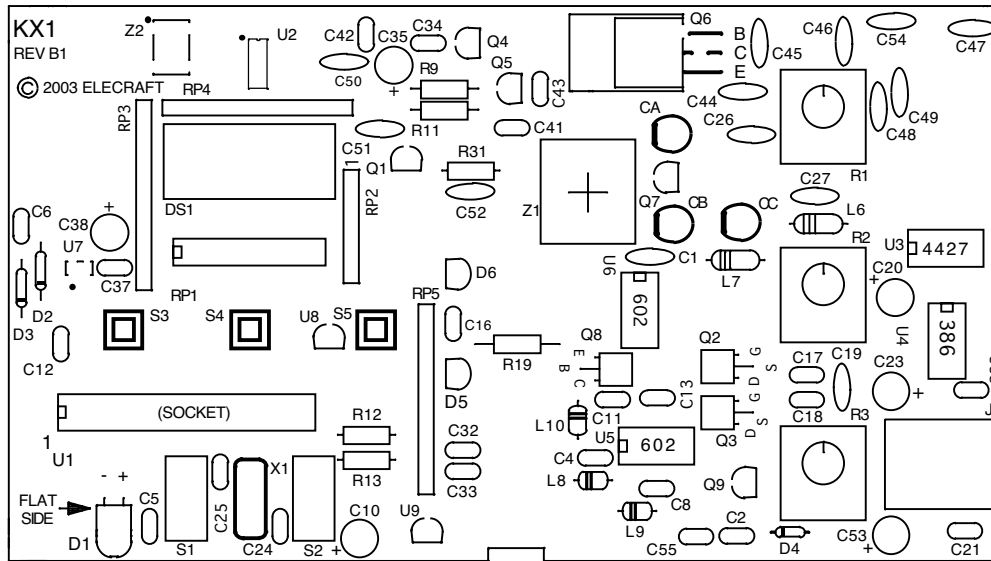
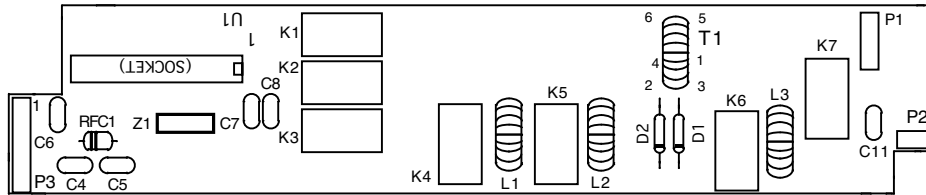

KXPD1 REV B
© 2003
ELECRAFT

KXPD1 REV B
© 2003
ELECRAFT

G C B G
ELECRAFT
KXB30
REV B1
D 5
COPYRIGHT 2003 G

Appendix F Parts Placement Drawing (Bottom)

(Includes KXPDI, KXB30, and KXAT1 boards)

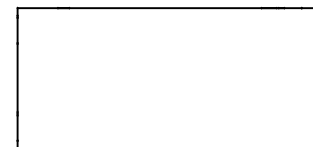
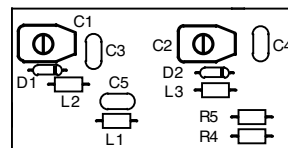
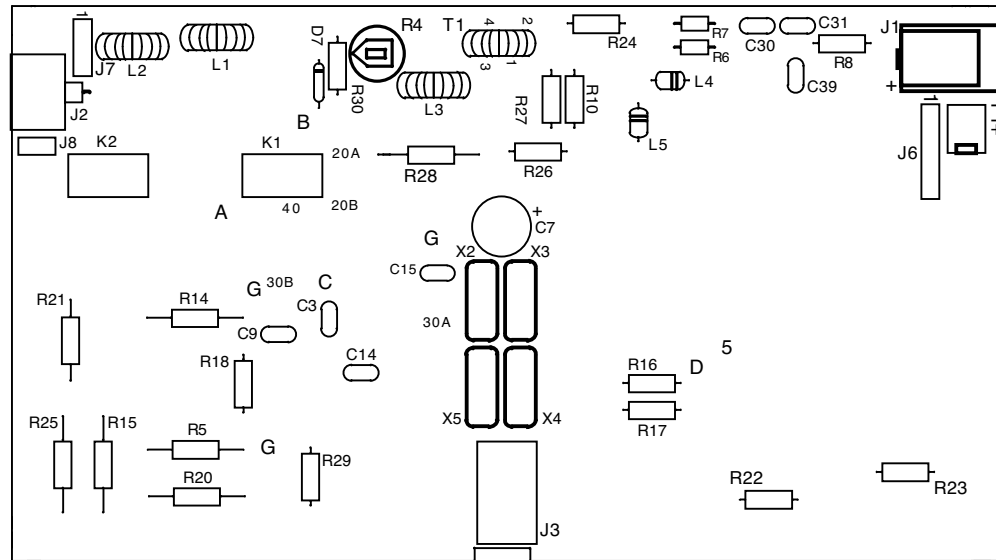
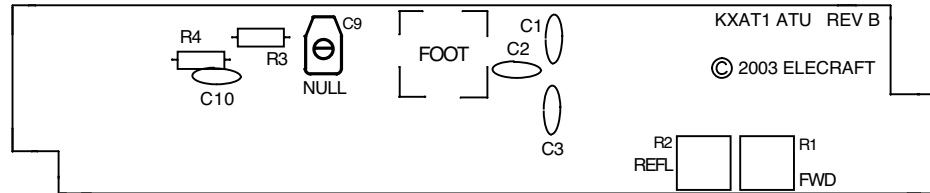

ELECRAFT KX1 QUICK REFERENCE

BAND/SPEED

Tap once to show band, twice (quickly) to change bands. Hold to set keyer speed with VFO knob

TUNE (key-down) :

Hold MENU + BAND; tap any switch after power is displayed

DISP (display mode):

Hold BAND + RIT; norm, Smtr, battery

RX MODE (sideband):

Hold MENU + RIT; norm, LSB, USB

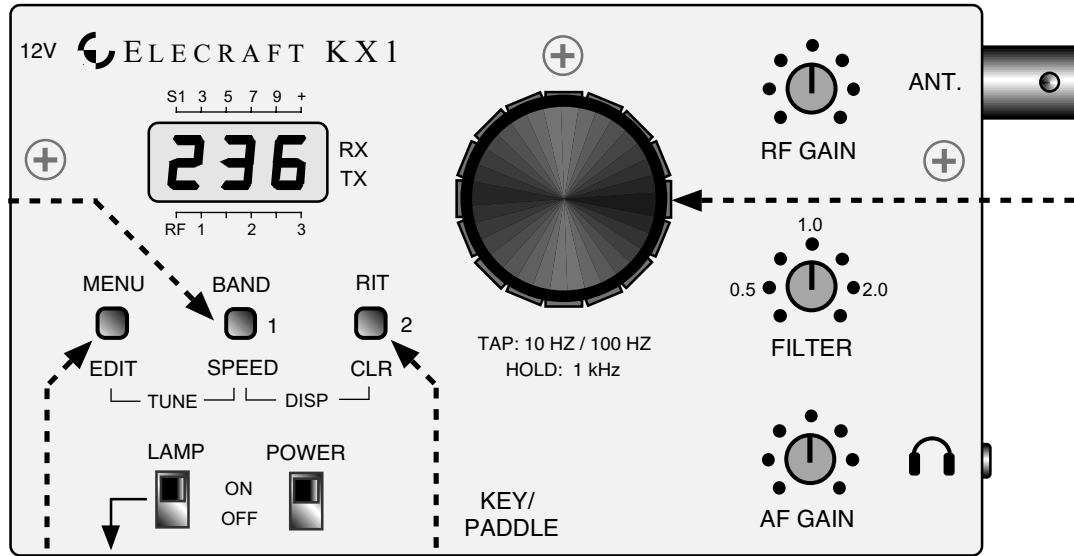

RIT/CLR Tap for RIT on/off, hold for RIT clear

VFO KNOB FUNCTIONS

TUNING RATE:

Tap for 10/100 Hz, hold for 1 kHz (5 kHz in LSB/USB receive modes)

LOCK/UNLOCK:

RIT + VFO knob

HIGH-PRIORITY MEM:

BAND + VFO knob

SWITCH CW:

MENU + VFO knob

MENU/EDIT Tap to enter menu, hold to edit (except **RCL** and **PLY**); use VFO knob to scroll menu or modify parameters

LED	LED LEVEL (tap BAND or RIT); LED TIMEOUT, use VFO knob	IAB	IAMBIC MODE, A or B	BAT	BATTERY WARNING THRESHOLD
STL	SIDETONE VOLUME LEVEL, 0-3	CFB	AUDIBLE CW FEEDBACK, OFF or 10-40 WPM in 5 WPM steps	ATU	AUTO-TUNER MODE (see ATU manual)
STP	SIDETONE PITCH, 500-700 Hz	SLO	S-METER ZERO SET	RCL	MEMORY RECALL (tap 1, 2, or VFO); STORE (EDIT, tap 1, 2, or VFO; hold rather than tap = high priority)
T-R	QSK DELAY, 0-900 ms	SHI	S-METER SCALE	PLY	MESSAGE PLAY (tap 1 or 2; tap VFO knob for CW test mode, P=0); RECORD (EDIT, tap 1 or 2)
RPT	AUTOREPEAT DELAY, 0-255 sec	B30	30-M BAND on/off		
INP	KEYING DEVICE: Hnd, PDn, PDr	CAL	VFO CALIBRATION (see manual)		