



ELECRRAFT® KXPA100

100-WATT AMPLIFIER

KIT ASSEMBLY MANUAL

Revision A3, February 15, 2016

E740221

Copyright © 2016, Elecraft, Inc.
All Rights Reserved

Contents

Introduction.....	3
Customer Service and Support.....	3
Tools Required for Assembly	4
Preventing Electrostatic Discharge Damage	5
Choosing an Anti-Static Mat.....	5
Unpacking and Inventory	6
Assembly Procedure.....	7
Rear Panel Assembly	8
KXAT100 Antenna Tuning Unit.....	10
Connecting the Rear Panel Cables	15
Installing the Enclosure.....	18
Setup and Operation.....	23
Appendix A Illustrated Parts List.....	A1

 Elecraft manuals with color images may be downloaded from www.elecraft.com.

Introduction

This manual will guide you through assembly of your Elecraft KXPA100 amplifier.

The optional KXAT100 antenna tuning unit (ATU) fits inside the KXPA100 enclosure. If you purchased the KXAT100, you'll find complete instructions for installing it as you assemble the amplifier.

We're confident that you'll find the KXPA100 easy to build, even if you've had no prior kit-building experience.

Every modern amplifier is complex, and the KXPA100 is no exception. All of the circuit boards have been fully tested and aligned. No test equipment is required. Only a few hand tools are needed to assemble your kit (see page *Tools Required for Assembly* on page 4).

⚠ The modules are shipped in ESD-safe bubble wrap and ESD-safe envelopes. Do not handle them without first taking the ESD precautions listed on page 5.

Should you have difficulty, you'll have our full support via phone and e-mail. In addition, we hope you'll join our growing and enthusiastic community of owner/builders via the Elecraft reflector.

Further information about the Elecraft KXPA100, including specifications, installation, and operation instructions, can be found in the Owner's Manual.

Customer Service and Support

Technical Assistance

You can send e-mail to kx3support@elecraft.com and we will respond quickly – typically the same day Monday through Friday. If you need replacement parts, send an e-mail to parts@elecraft.com. Telephone assistance is available from 9 A.M. to 5 P.M. Pacific time (weekdays only) at 831-763-4211. Please use e-mail rather than calling when possible since this gives us a written record of the details of your problem and allows us to handle a larger number of requests each day.

Repair / Alignment Service

If necessary, you may return your Elecraft product to us for repair or alignment. (Note: We offer unlimited email and phone support, so please try that route first as we can usually help you find the problem quickly.)

IMPORTANT: You must contact Elecraft before mailing your product to obtain authorization for the return, what address to ship it to and current information on repair fees and turnaround times. (Frequently we can determine the cause of your problem and save you the trouble of shipping it back to us.) Our repair location is different from our factory location in Aptos. We will give you the address to ship your kit to at the time of repair authorization. *Packages shipped to Aptos without authorization will incur an additional shipping charge for reshipment from Aptos to our repair depot.*

Elecraft 1-Year Limited Warranty

This warranty is effective as of the date of first consumer purchase (or if shipped from the factory, the date the product is shipped to the customer). It covers both our kits and fully assembled products. For kits, before requesting warranty service, you should fully complete the assembly, carefully following all instructions in the manual.

Who is covered: This warranty covers the original owner of the Elecraft product as disclosed to Elecraft at the time of order. Elecraft products transferred by the purchaser to a third party, either by sale, gift, or other method, who is not disclosed to Elecraft at the time of original order, are not covered by this warranty. If the Elecraft product is being bought indirectly for a third party, the third party's name and address must be provided at time of order to ensure warranty coverage.

What is covered: During the first year after date of purchase, Elecraft will replace defective or missing parts free of charge (post-paid). We will also correct any malfunction to kits or assembled units caused by defective parts and materials. Purchaser pays inbound shipping to us for warranty repair; we pay shipping to return the repaired equipment to you by UPS ground service or equivalent to the continental USA and Canada. For Alaska, Hawaii, and other destinations outside the U.S. and Canada, actual return shipping cost is paid by the owner.

What is not covered: This warranty does not cover correction of kit assembly errors. It also does not cover misalignment; repair of damage caused by misuse, negligence, battery leakage or corrosion, or builder modifications; or any performance malfunctions involving non-Elecraft accessory equipment. The use of acid-core solder, water-soluble flux solder, or any corrosive or conductive flux or solvent will void this warranty in its entirety. Also not covered is reimbursement for loss of use, inconvenience, customer assembly or alignment time, or cost of unauthorized service.

Limitation of incidental or consequential damages: This warranty does not extend to non-Elecraft equipment or components used in conjunction with our products. Any such repair or replacement is the responsibility of the customer. Elecraft will not be liable for any special, indirect, incidental or consequential damages, including but not limited to any loss of business or profits.

Tools Required for Assembly

1. ESD Protection (see *Preventing Electrostatic Discharge Damage*, pg 5)
2. #1 size Phillips screwdriver. Some makes of size #0 screwdriver may fit better. Always use the screwdriver that best fits the screw in each step. To avoid damaging screws and nuts, a power screwdriver is *not* recommended.
3. Needle-nose pliers, 4" to 6" is ideal.
4. Soft cloth or clean, soft static-dissipating pad to lay cabinet panels on to avoid scratching.

Preventing Electrostatic Discharge Damage

Sensitive components may be damaged by Electrostatic Discharge (ESD) simply by touching them or a circuit board containing them unless you take specific steps to prevent such damage. Damage may occur with static discharges far too little for you to notice.

A damaged component may not fail completely at first. Instead, the damage may result in below-normal performance for an extended period of time before you experience a total failure.

Parts which are especially ESD-sensitive are identified in the parts list and in the assembly procedures.

We strongly recommend you take the following anti-static precautions (listed in order of importance) to ensure there is no voltage difference between the components and any object that touches them:

- Leave ESD-sensitive parts in their anti-static packaging until you install them. The packaging may be a special plastic bag that allow static charges to flow harmlessly over their surface, or a component's leads may be inserted in conductive foam that keep them at the same potential.
- Wear a conductive wrist strap with a series 1-megohm resistor that will constantly drain off any static charge that accumulates on your body. If you do not have a wrist strap, touch a ground briefly before touching any sensitive parts to discharge your body. Do this frequently while you are working. You can collect a destructive static charge on your body just sitting at the work bench.

WARNING

DO NOT attach a ground directly to yourself without a current-limiting resistor as this poses a serious shock hazard. A wrist strap must include a 1-megohm resistor to limit the current flow. If you choose to touch an unpainted, metal ground to discharge yourself, do it only when you are not touching live circuits with any part of your body.

- Use a grounded anti-static mat on your work bench (see below).
- If you pick up a pc (printed circuit) board that was not placed on an anti-static mat or in an anti-static package, first touch a ground plane connection on the board such as a connector shell or mounting point.
- If you use a soldering iron to work on a circuit board, be sure your iron has an ESD-safe grounded tip tied to the same common ground used by your mat and wrist strap.

Choosing an Anti-Static Mat

An anti-static mat must bleed off any charge that comes in contact with it at a rate slow enough to avoid a shock or short circuit hazard but fast enough to ensure dangerous charges cannot accumulate. Typically, a mat will have a resistance of up to 1 Gigaohm (10^9 ohms). Testing a mat requires specialized equipment, so we recommend that you choose an anti-static mat that comes with published resistance specifications and clean it as recommended by the manufacturer. Testing has shown that many inexpensive mats that do not specify their resistance have resistance values much too high to provide adequate protection, even after they were cleaned and treated with special anti-static mat solutions.

Suitable anti-static table mats are available from many sources including:

- U-line (Model 12743 specified at 10^7 ohms)
- Desco (Model 66164, specified at 10^6 to 10^8 ohms)
- 3M™ Portable Service Kit (Model 8505 or 8507, specified at 10^6 to 10^9 ohms)

Unpacking and Inventory

CAUTION

Do not handle the circuit board assemblies without anti-static protection! Doing so may damage sensitive components. See *Preventing Electrostatic Discharge Damage* on page 5 for important information about handling the boards.

Do a complete inventory before starting construction, comparing the parts in your kit with the parts list in Appendix A to familiarize yourself with all of the parts and to ensure the kit is complete. When inventorying, look in the sealed envelopes to identify their contents, but not mix them up. A paper clip or piece of tape will hold the envelopes closed after you check their contents. Note that a few extras of some screws, nuts and washers may have been included on purpose.

All dimensions given in the assembly procedure are provided in both US Customary (often called English) and metric measurements. The native dimensions of the parts are in US Customary units. Approximate metric equivalents are given to assist those more familiar with the metric system to identify the correct parts.

Screws

A number of different types and sizes of screws and washers are used in the assembly. It is very important that you use the screw specified in each location or your finished KXPA100 may not fit together properly. In some places, using the wrong size screw may damage components. The following various screw types and sizes specified in the text are shown in Figure 1. Images are shown for comparing relative sizes. Due to the printing process used, they may not be exactly to scale. The lengths of the screws called for in the text are measured as shown.



Figure 1. Screws Used to Assemble Your KXPA100.

Standoffs and Spacers

A number of threaded M-F standoffs and unthreaded spacers are used. Their lengths are measured as shown in Figure 2.

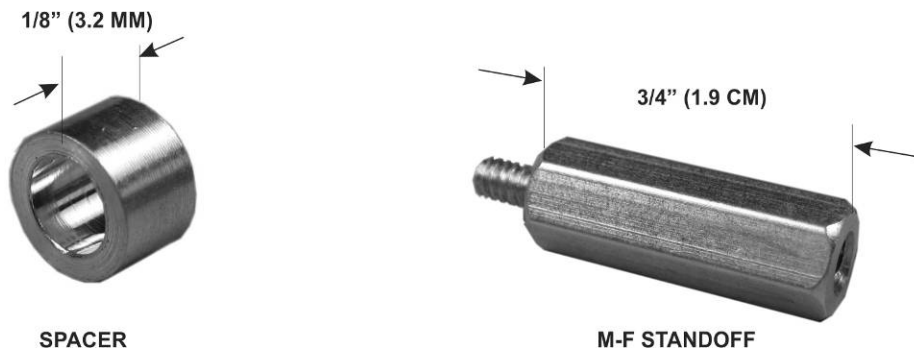

Figure 2. Standoffs and Spacers Used to Assemble Your KXPA100.

Assembly Procedure

IMPORTANT ASSEMBLY INFORMATION

- **Check off the steps as you finish each one.** Skipping a step is easy to do without taking a moment to be certain that you completed the previous step. This can result in serious damage to your KXPA100 or, at a minimum, having to disassemble it to correct the mistake.
- **Use your rule to check the length of screws and standoffs before installing them.** Some components are only 1/16” different from others but using the wrong size may result in parts not fitting correctly, possibly damaging electrical and mechanical components. See *Screws* and *Standoffs* on pg 6 for measurement instructions.
- **Start all the screws in an assembly before tightening.** When mounting parts with multiple screws or adjacent parts that fit together, start all the screws in the threads before tightening any of them. If you find that a screw is binding, loosen the other screws to free it, and then re-tighten.
- **Ensure all screws are tight but do not over-tighten.** Do not attempt to turn screws and nuts beyond the point at which the lock washer is compressed. Screws without lock washers should be tightened only until you feel significant resistance to further turning. Do not attempt to turn screws or nuts 1/4 turn beyond “tight”.
- **Threads can be easily stripped** if too much force is applied when tightening screws. Use the correct size hand tool and apply only moderate torque. Do not use a power screwdriver!
- **Do not adjust the turns on any toroids.** The position of the turns on the cores of many toroids has been adjusted at the factory to produce exactly the inductance needed for the circuit to work properly. Any attempt to adjust their position or to make a coil look “nicer” may seriously degrade circuit performance.
- **Remember your ESD protection.** Failure to observe ESD precautions may result in your KXPA100 not operating at all, or operating but not meeting normal factory performance specifications due to damaged components. See *Preventing Electrostatic Discharge Damage* on pg 5.
- **Handle Printed Circuit (PC) Boards by their Edges.** Avoid unnecessary mechanical stress on any pc board components by careless handling.

Rear Panel Assembly

□ Locate the rear panel. The inside surface should be clean bare metal. It was taped to avoid overspray during painting. Remove any tape still present. If a large area is taped, you can break it away near one corner using a blunt tool that fits through a screw hole as shown in Figure 3 and then peel it off of the panel.



Figure 3. Removing Masking Tape from the Rear Panel.

□ Install SO239 connectors in the ANT1 and RF IN openings in the rear panel as shown in Figure 4. Be sure you put the connector with the length of coax in each hole as shown or you won't be able to plug them in later.

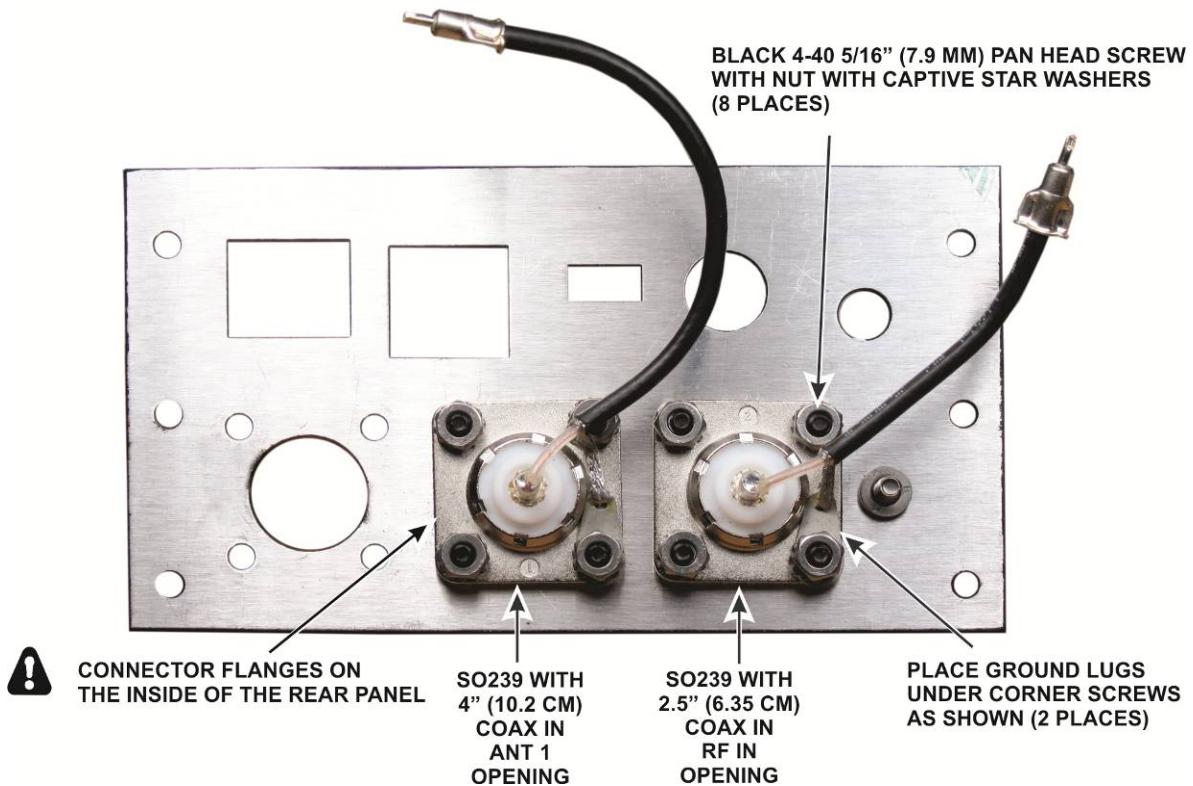

Figure 4. Installing the ANT1 and RF IN SO239 Connectors in the Rear Panel.

- Place two #6 flat washers on the black thumbscrew and thread it into the threaded bushing GND next to the RF IN connector on the rear panel as shown in Figure 5.

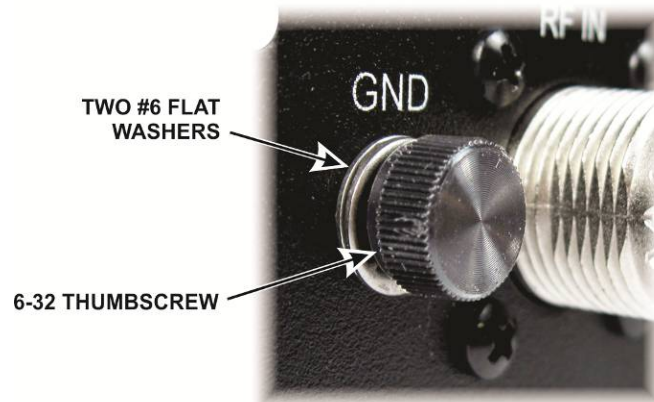

Figure 5. Installing the Ground Thumb Screw on the Rear Panel.

- Taking ESD precautions, remove the KXPA100 RF Assembly from its wrapping and place it heat sink down on your work table. This assembly consists of the heat sink with the KXPA100 PA Module attached and the KXPA100 LPF module mounted on it. With the heat sink sitting on your table, the LPF Module is the top pc board.

⚠ Take care not to disturb the toroidal inductors.

KXAT100 Antenna Tuning Unit

If you do not have the optional KXAT100 Antenna Tuning Unit, go directly to *Connecting the Rear Panel Cables* on page 15.

There are four pan head screws securing the LPF Module to the standoffs below it. Remove each screw and lock washer and replace it with an M-F standoff as shown in Figure 6. Save the screws and lock washers to use when installing the ATU Module later. Do not use a lock washer between the standoff and the LPF module.

⚠ Do not over-tighten. It is easy to strip threads or twist the threaded section off of the standoff, especially if using a nut driver.

**REMOVE THE BLACK PAN HEAD SCREWS AND LOCK WASHERS
AND INSTALL 4-40 3/4" (1.9 CM) M-F STANDOFFS (4 PLACES)**

⚠ DO NOT USE LOCKWASHERS

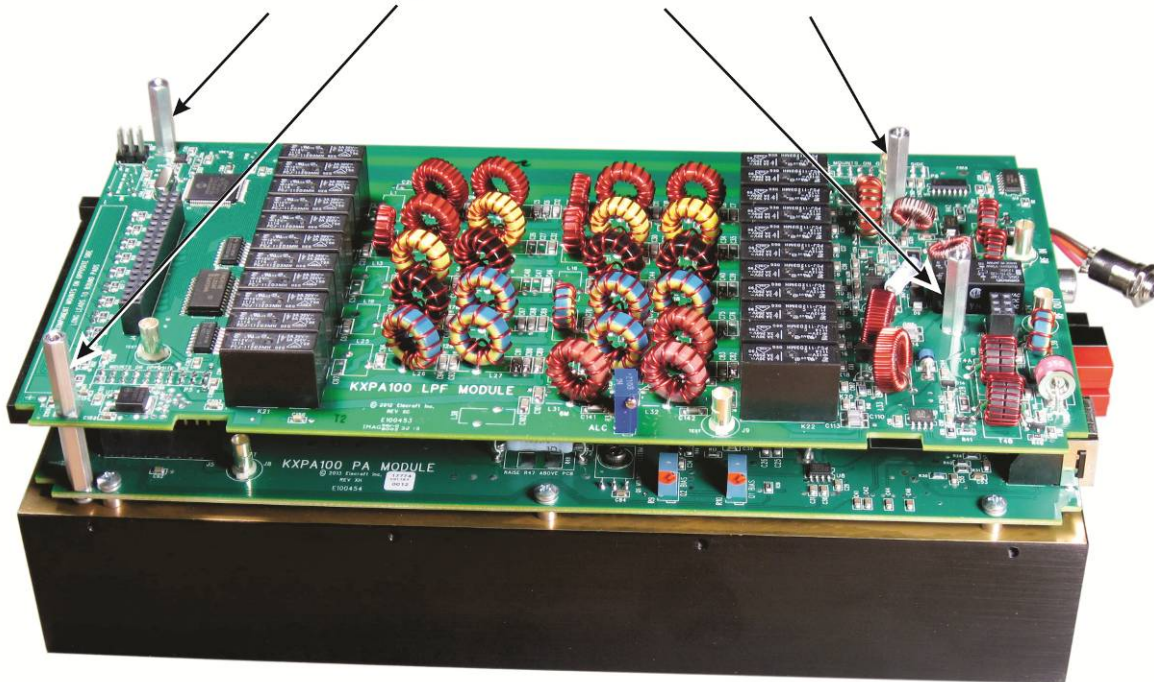

Figure 6. Installing Standoffs for the KXAT100 Module.

□ Taking ESD precautions, remove the ATU module pc board from its packaging. Place it on the standoffs you just installed so that the two plugs on the ATU module mate with their corresponding sockets on the LPF module as shown in Figure 7. Be sure that both connectors are properly aligned so all of their pins engage.

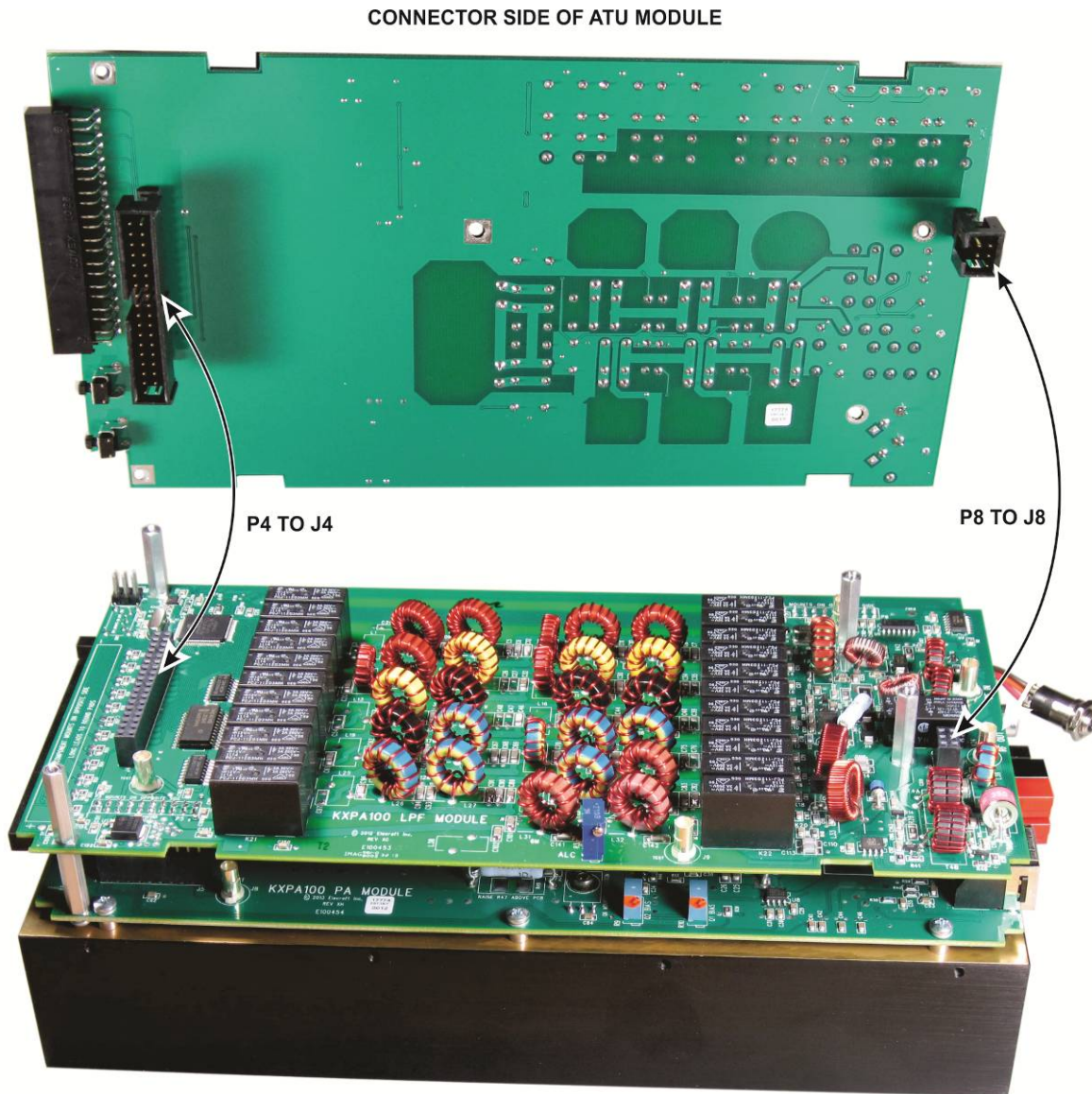

Figure 7. Mating the ATU Module with the LPF Module.

☐ Secure the ATU module pc board to the four standoffs using the screws and lock washers you removed earlier as shown in Figure 8. Note that there is a hole near the center of the ATU module that is not used.

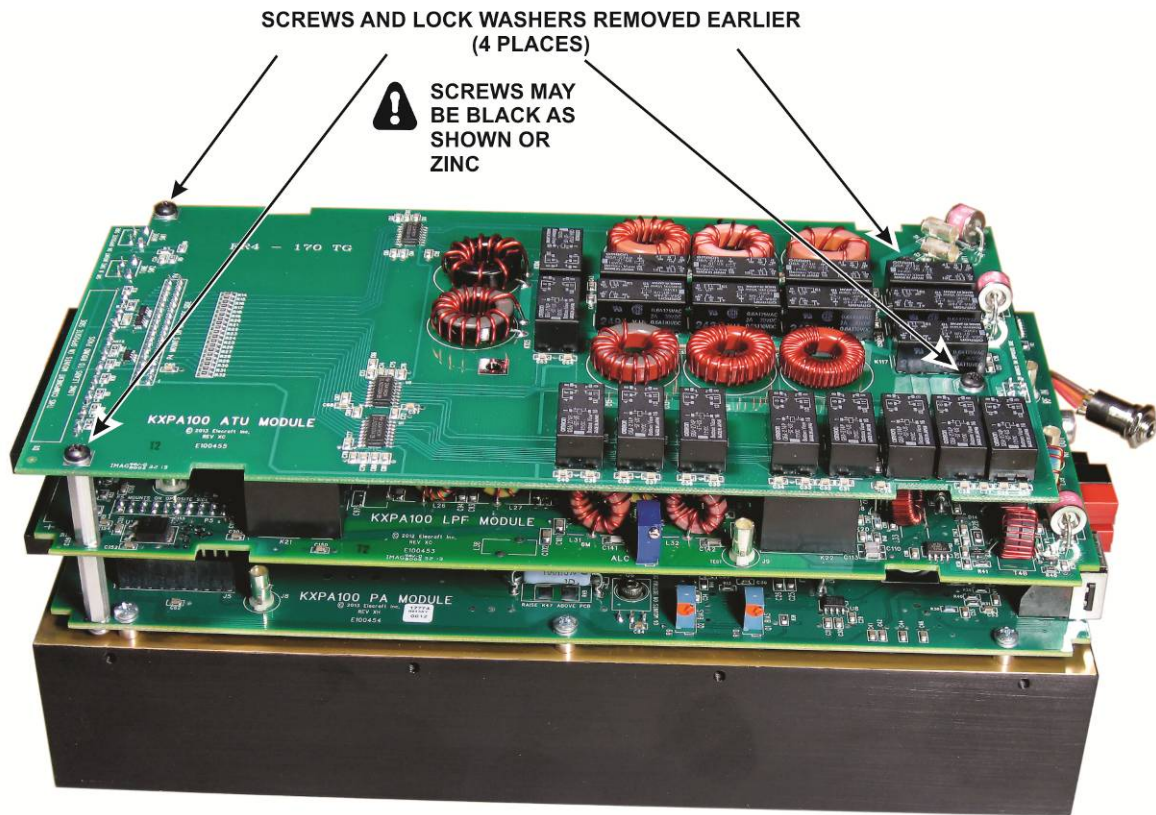

Figure 8. Securing the ATU Module to the Standoffs.

☐ Press the black switch caps on the MODE and TUNE switches next to the LEDs on the ATU module (see Figure 9). Do not press hard. They are a simple friction fit.

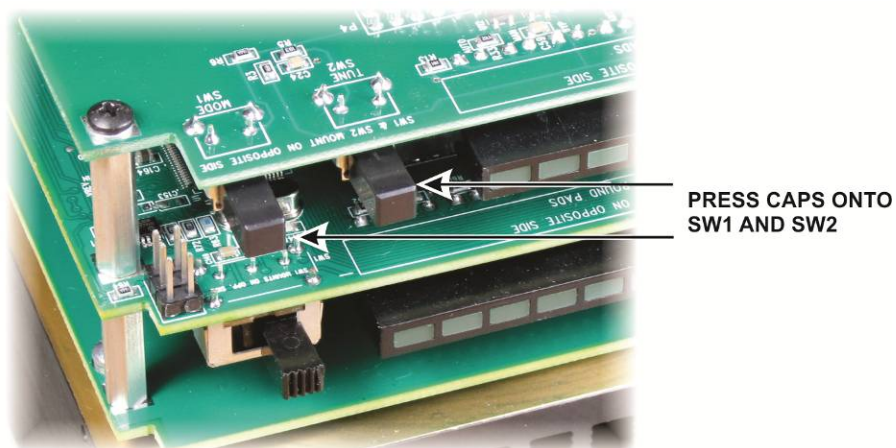

Figure 9. Installing the MODE and TUNE Switch Caps

□ The spacing between the ATU module and the low pass filter board below it is critical for the front panel to fit and the switches to operate smoothly. Before proceeding with the assembly, check to ensure the spacing is correct as follows:

- Unwrap the front panel, remove any tape on the reverse side just as you did for the rear panel (see Figure 3) and place it over the LEDs and switches as shown in Figure 10. The fit may be snug, but both rows of LEDs must fit in the openings:
- Press the MODE and TUNE switches. They move only a small amount, but you should feel a definite movement when pressed and the switch should return by itself when released.
- Ensure the OFF/ON slide switch moves easily.

If you have difficulty fitting the front panel over the LEDs or the switches stick when pressed, increase the spacing between the ATU module and the low pass filter board by removing the ATU module and adding one split ring lock washer under each spacer as shown in Figure 11. Replace the ATU Module and confirm that the switches now operate smoothly.

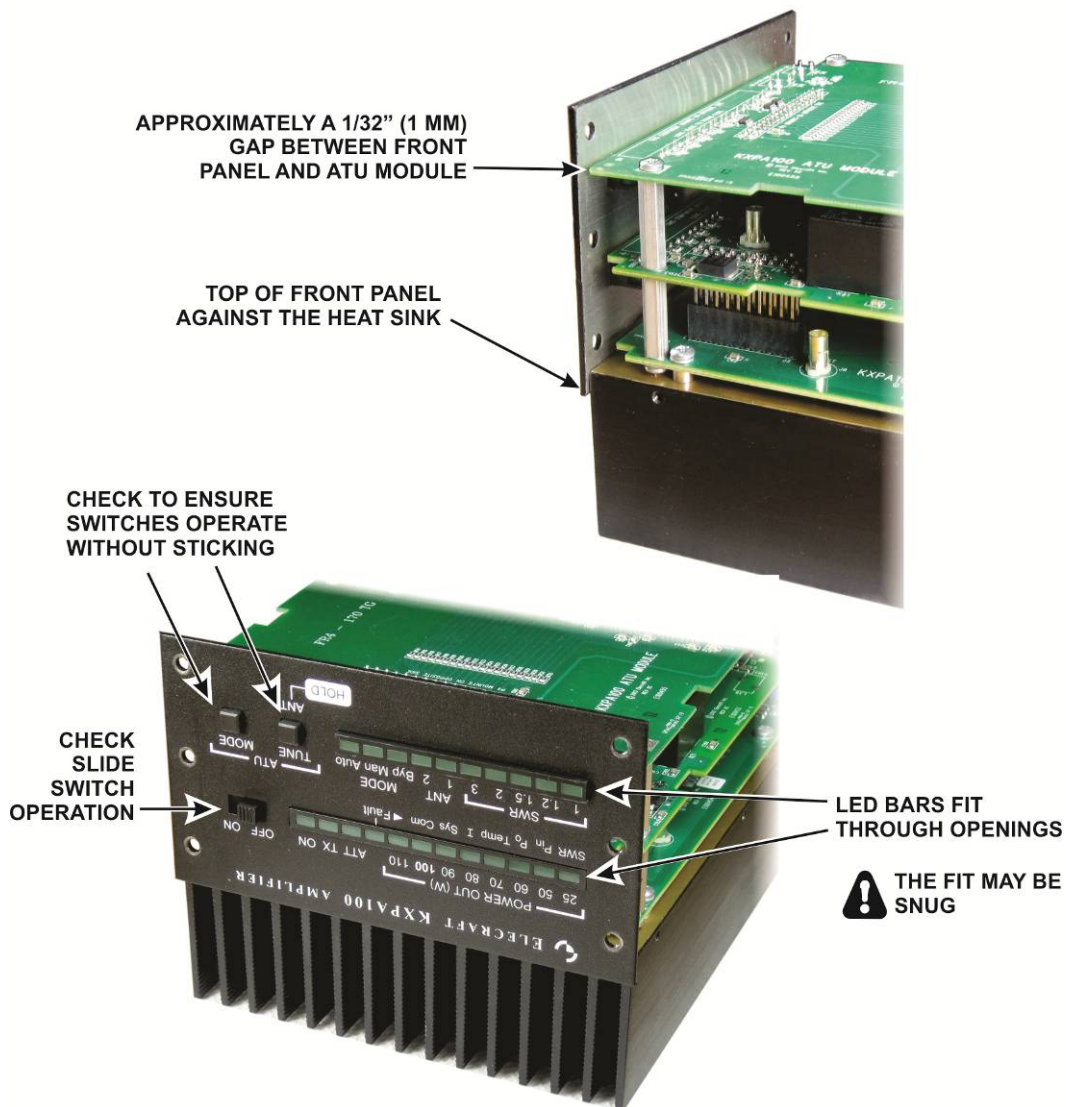

Figure 10. Testing Front Panel Fit.

⚠ Add the lock washer as shown below only if the front panel does not fit as shown in Figure 10.

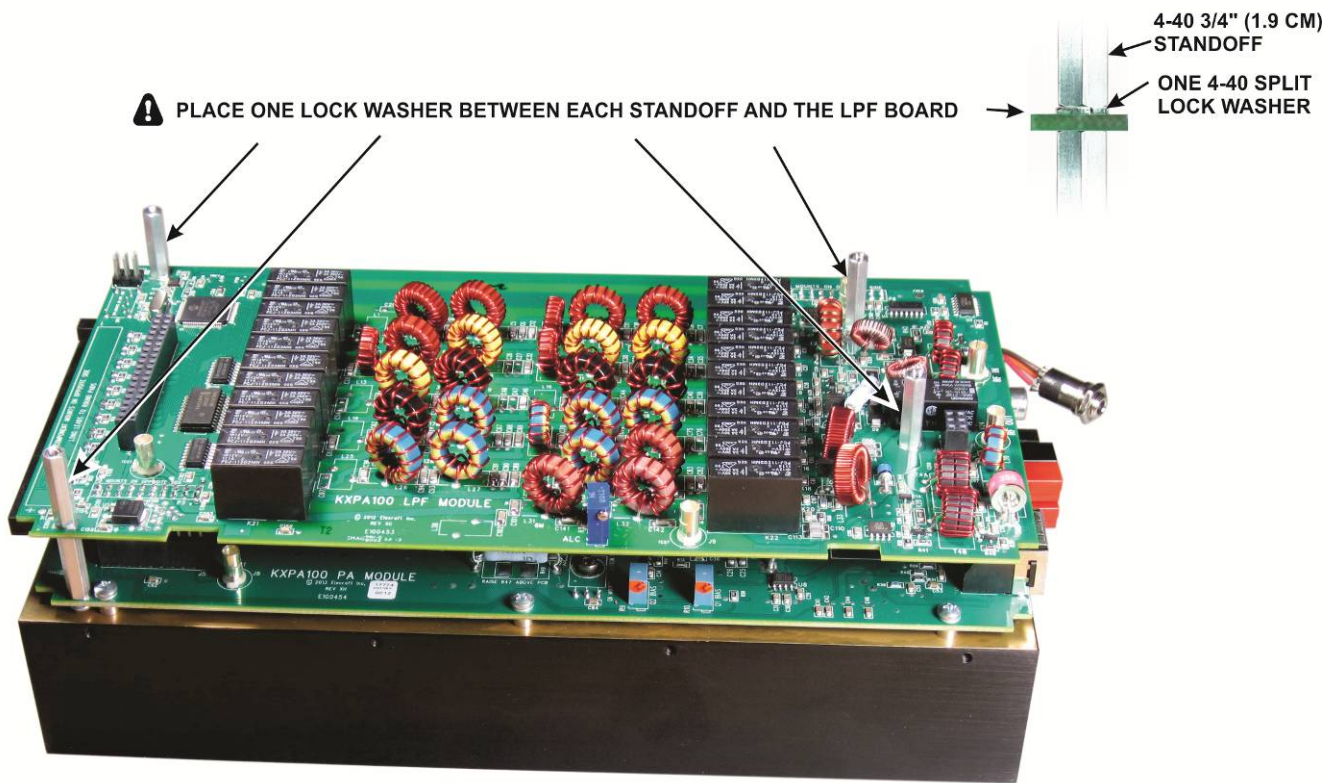

Figure 11. Adding Lock Washer to Standoffs.

Remove the front panel and set it aside. It will be installed later.

Locate the envelope containing the SO-239 connector with a 4" (10.2 cm) cable attached packed with the ATU module and install it in the ANT 2 opening on the rear panel as shown in Figure 12.

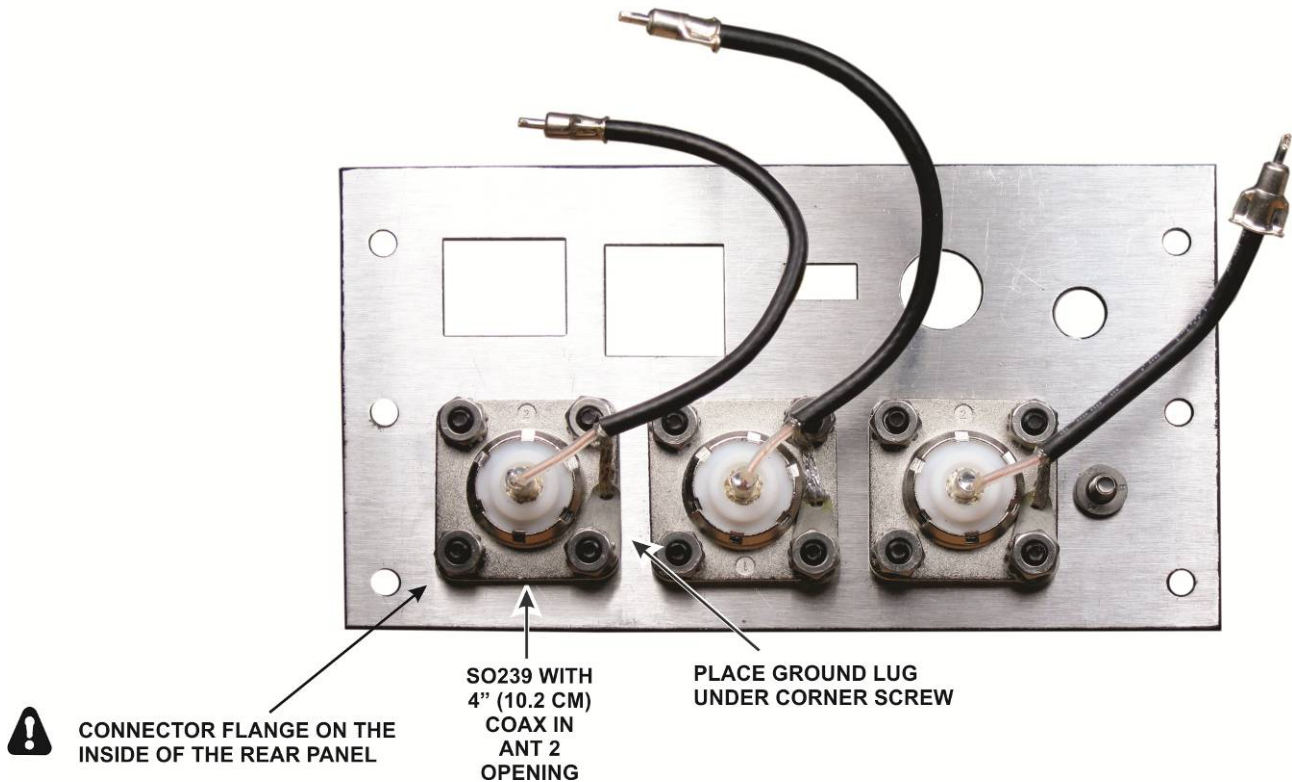

Figure 12. Mounting the ANT2 Connector on the Rear Panel.

Connecting the Rear Panel Cables

Locate the small connector attached by leads at one end of the amplifier. Check to see if it has a hex nut threaded on it (Figure 13). If so, remove it. You'll use the nut to secure the connector to the rear panel later.

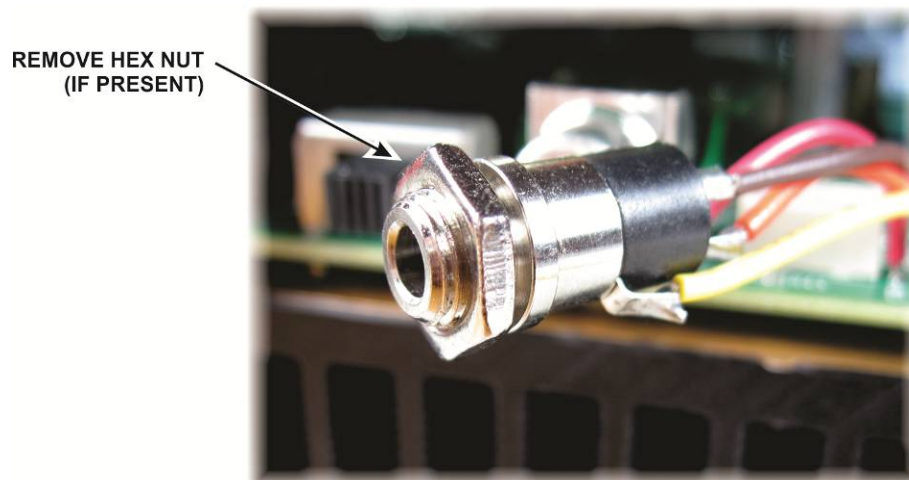

Figure 13. Hex Nut on Small Socket.

- Connect the cables with the TMP connectors on the rear panel to the amplifier as follows:
 - If you have the optional KXAT3 ATU, see Figure 15.
 - If you do not have the KXAT3 ATU, see Figure 16. Also insert the hole plug in the unused ANT2 opening as shown in the figure.

⚠ CAUTION

Failure to properly connect the cables may result in damage to your KXPA100.

Be sure the TMP connectors are fully mated as shown in Figure 14.

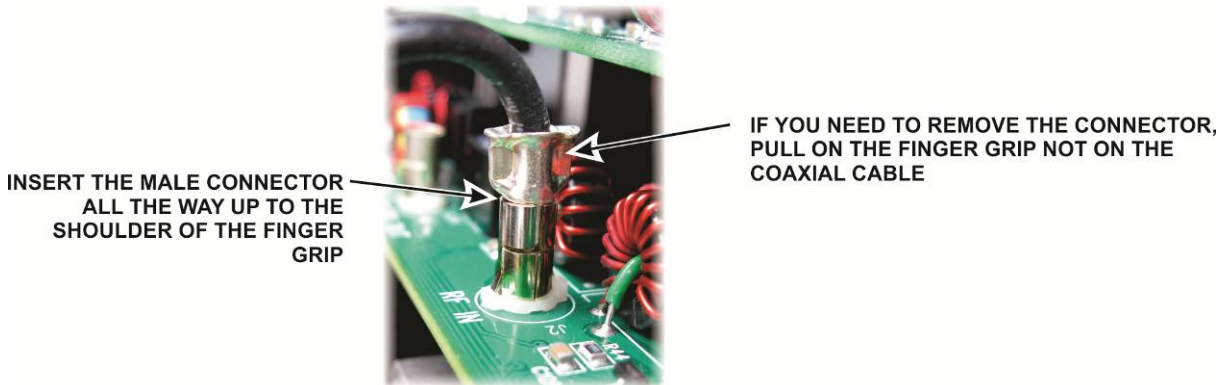

Figure 14. Mating TMP Connectors.

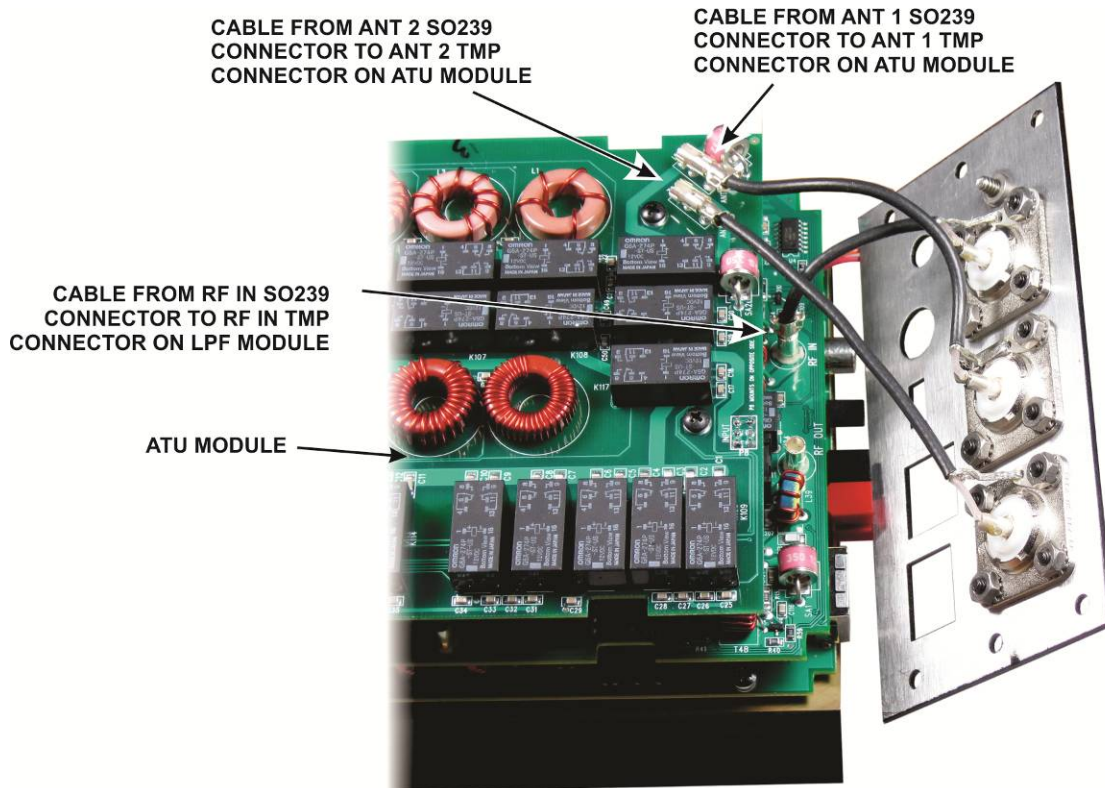

Figure 15. Connecting the Rear Panel Cables with ATU Installed.

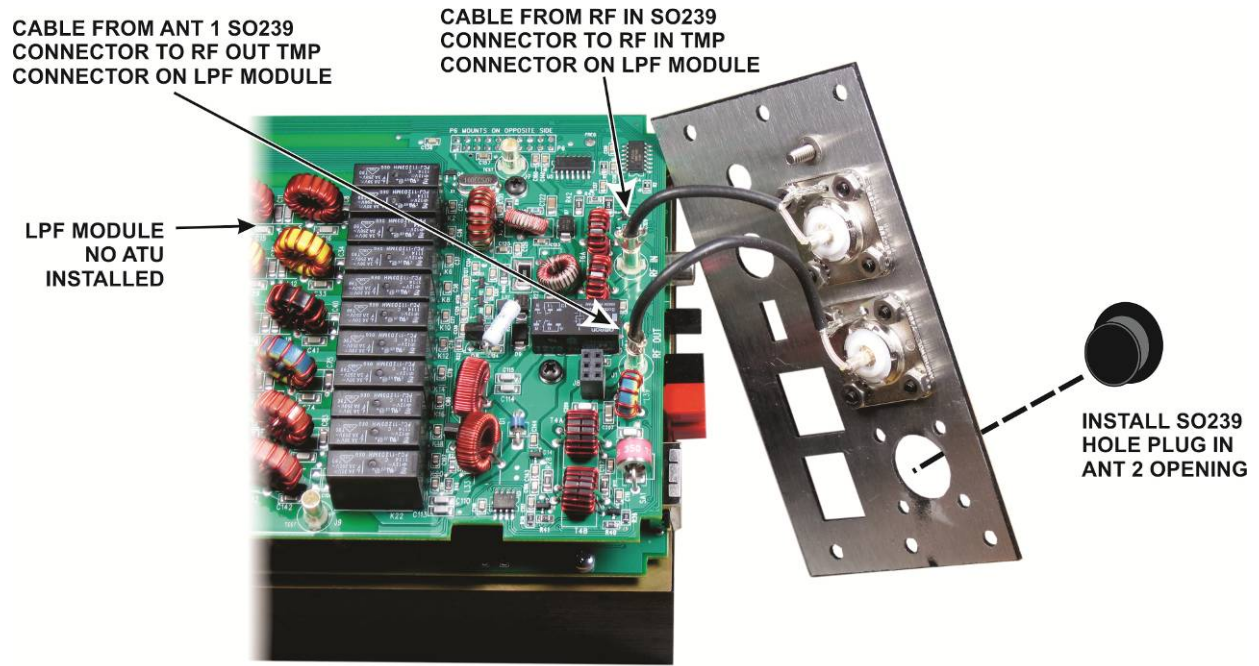

Figure 16. Connecting the Rear Panel Cables with no ATU.

Pass the small jack through the hole marked RS232 (PC) on the rear panel and secure it with the hex nut (see Figure 17).

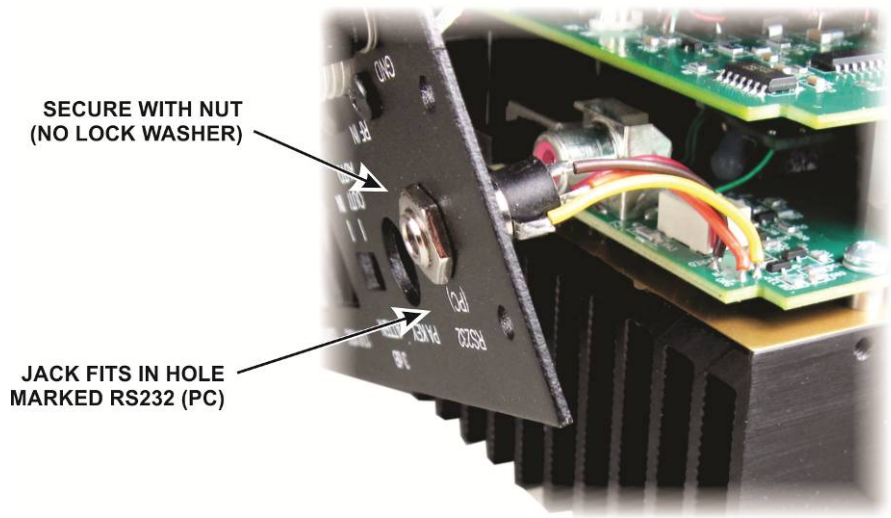

Figure 17. Mounting the RS232 Jack in the Rear Panel.

Installing the Enclosure

Unwrap the U-Cover and inspect the flanges at both ends to ensure they are clean metal. Remove any paint overspray or masking tape that may have been left on them. If they are still taped, you can lift one corner of the tape and it will peel off in one piece. Optionally you can push a blunt tool through one of the screw holes at the end and the tape will pop loose, making it easy to pull off (see Figure 18).

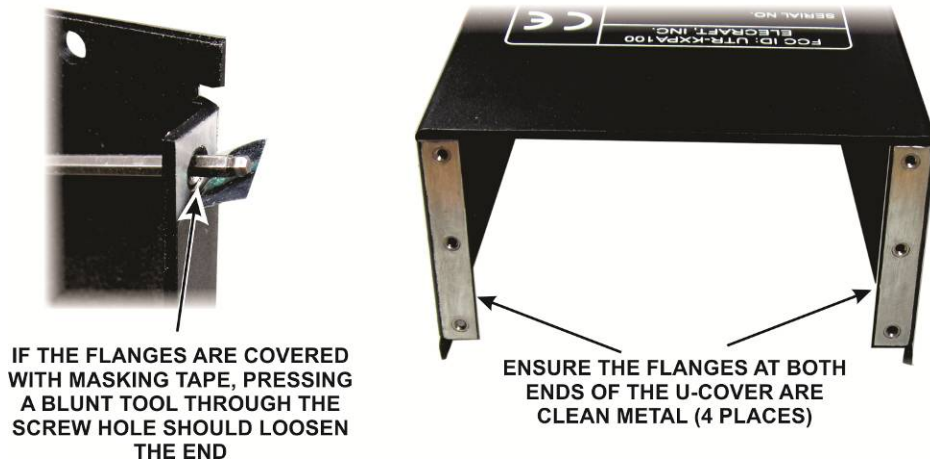

Figure 18. Removing Masking Tape from U-Cover Flanges.

Make a final check of the TMP connectors on the coaxial cables leading to the rear panel SO239 connectors to ensure each connector is fully inserted in the mating connectors.

☐ Place the U-Cover over the amplifier pc boards as shown in Figure 19. Be sure the lettering on the U-Cover is nearest to the rear panel with the SO239 connectors as shown, otherwise two of the bushings mounted in the side of the cover will strike the LPF module pc board.



Figure 19. Mounting the U-Cover.

☐ Position the rear panel against the end of the U-Cover so that the Control, 13.8 VDC, PA KEY connectors and the 3 dB ATTN switch pass through the openings in the cover. Tuck the coaxial cables into the space between the LPF board assembly and the U-cover as needed. Secure the rear panel with six screws, split ring lock washers and spacers as shown in Figure 20.

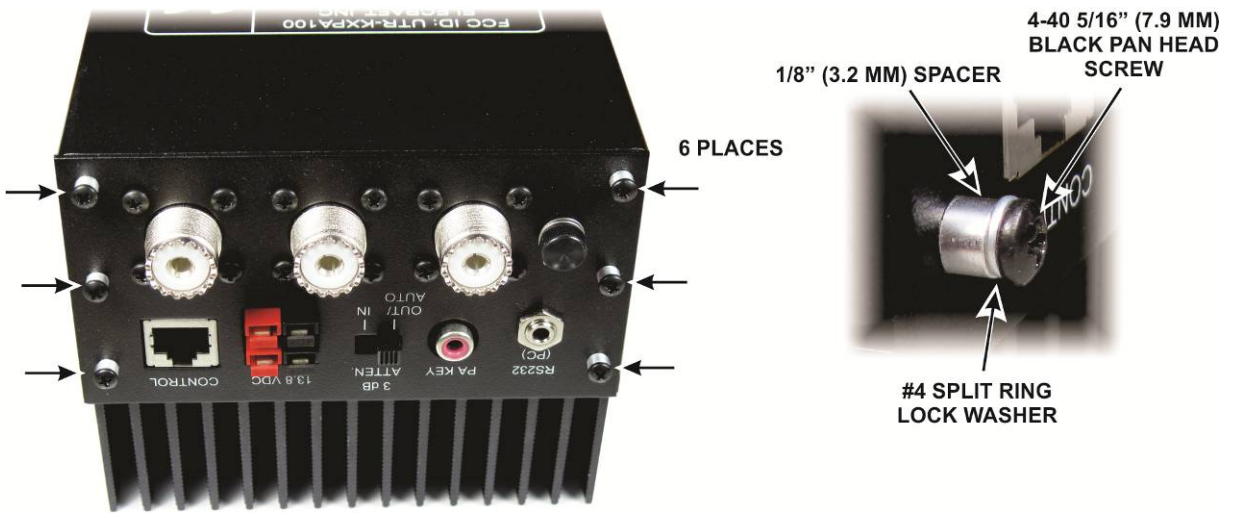

Figure 20. Mounting the Rear Panel.

□ Position the front panel so the LEDs, OFF/ON, TUNE and MODE switches fit through the openings. Secure the front panel with screws, lock washers and spacers just as you did on the rear panel (see Figure 21).

⚠ The front panel for a KXAT100 with the optional ATU is shown. The alignment of the panel with the switches and LEDs requires more care when the ATU is installed. Start securing the front panel with screws, lock washers and spacers in the opposite corners of the front panel and check to ensure the TUNE and MODE switches move freely. They only move a small amount when pressed but you should feel a definite movement. If necessary, loosen the hardware at one corner and adjust the front panel position slightly. When you are satisfied, install the remaining screws, lock washers and spacers.

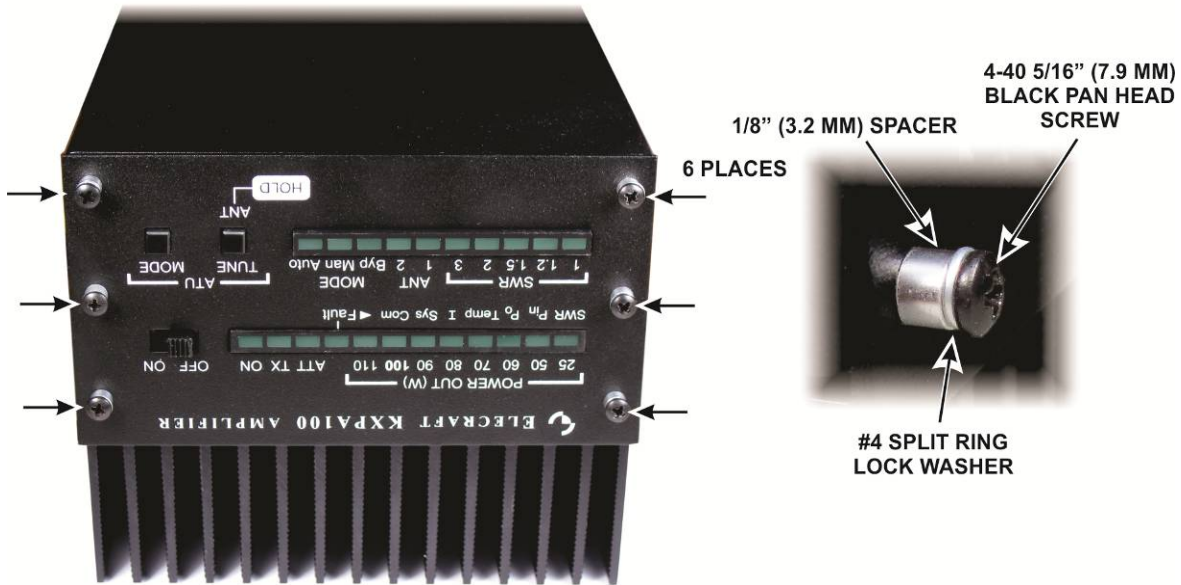

Figure 21. Mounting the Front Panel.

□ Install a foot at each corner of the enclosure as shown in Figure 22. When the foot is pressed over the screws, lock washers and spacers you installed earlier and against the corner of the enclosure, the three remaining holes in the foot will line up with threaded bushings in the U-Cover to receive the additional three screws, lock washers and spacers.

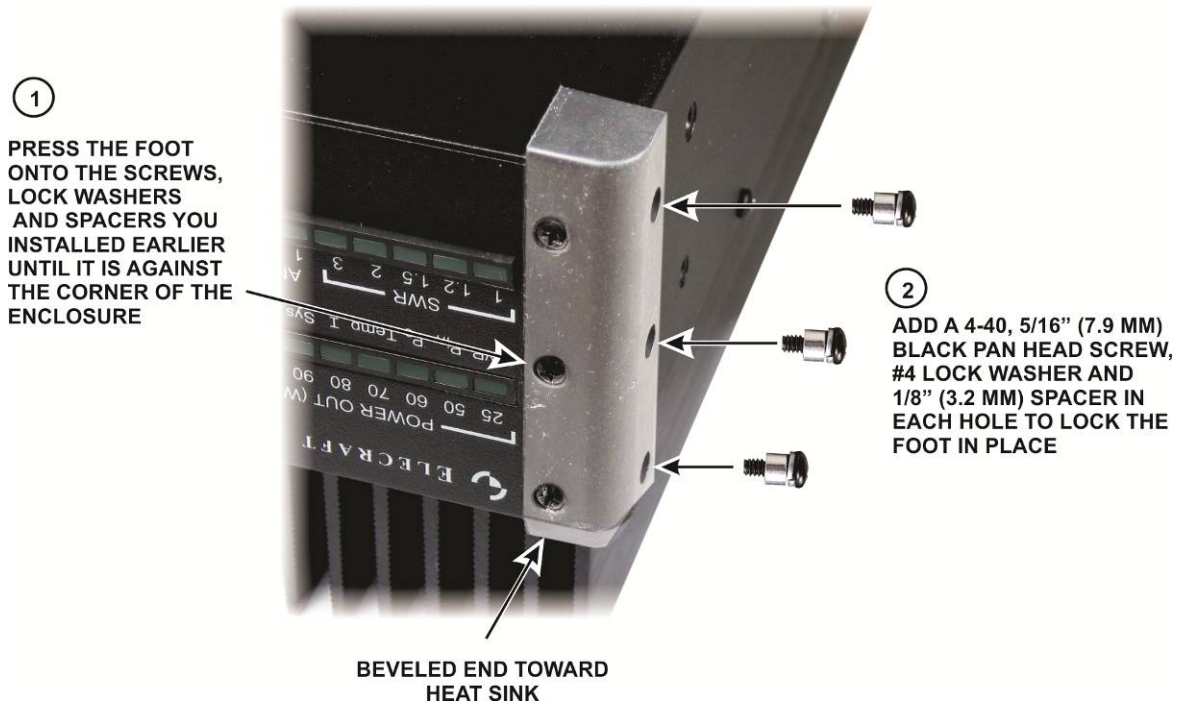

Figure 22. Installing the Feet.

Install the strap handle on the side of the KXPA100 as shown in Figure 23. Note that one side of the enclosure has two threaded bushings and the other side has four. Place the handle on the side with four bushings in the two closest to the heat sink. The other bushings are for mounting the amplifier to a bracket, if desired, as described in your Owner's Manual.

⚠ Do not over-tighten the screws. When properly tightened, the handle should lie flat against the side of the enclosure, but pull away far enough to admit your fingers when needed. Over tightening the screws may distort the end covers so they prevent movement.

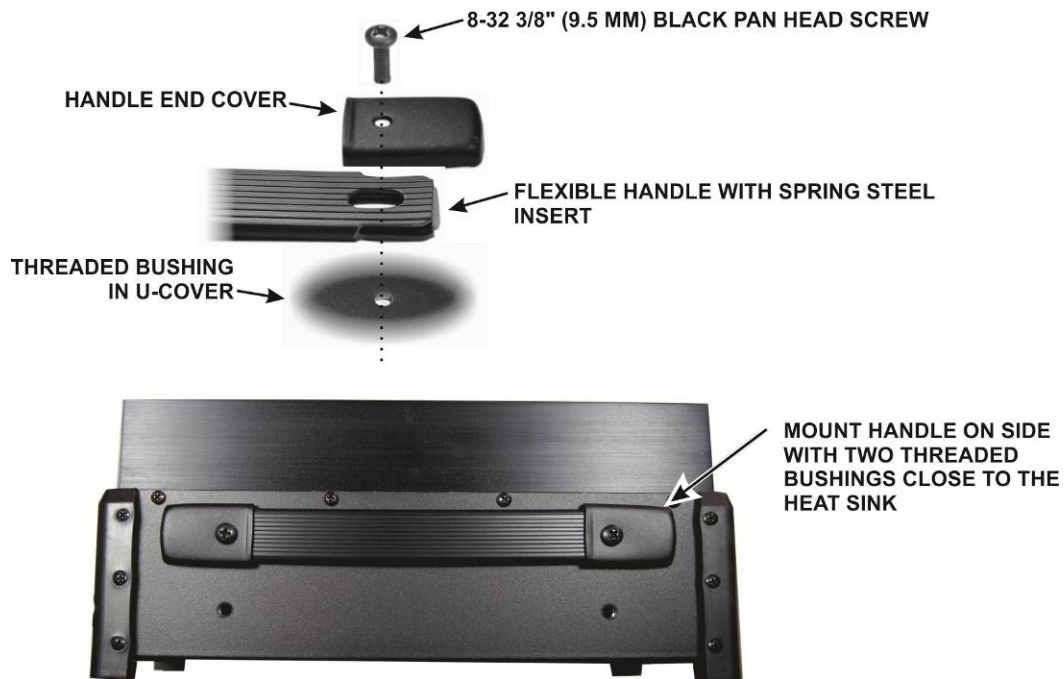

Figure 23. Mounting the Side Handle.

Set the KXPA100 on its heat sink and attach the self stick serial number in the place provided on the bottom (see Figure 24).

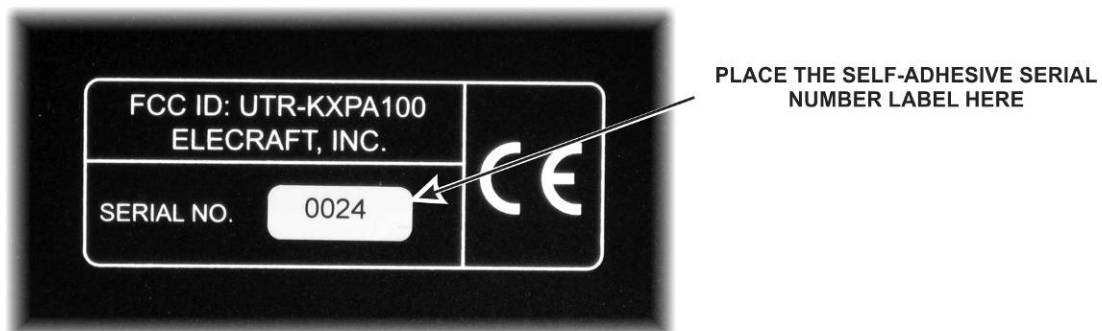

Figure 24. Attaching the Serial Number.

Setup and Operation

That completes the assembly of your KXPA100. Refer to your KXPA100 Owner's manual for Setup and Operation instructions.

Appendix A - Illustrated Parts List

Your kit contains a number of envelopes, boxes and packages of parts. Check the contents of each one carefully against the following lists. You may find extra screws, nuts and other small parts provided in case you lose one.

Power and Interface Cables

The cables supplied are described in the Owner's manual supplied with the kit.

⚠ CAUTION

In addition to taking ESD precautions, be careful not to damage components on either side of the circuit boards when handling them.





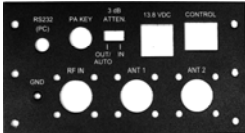

KXPA100-K RF Box E850586

ILLUSTRATION	DESCRIPTION	QTY.	ELECRAFT PART NO.
	RF Assembly	1	E870025

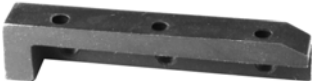

KXPA100-K Sheet Metal Box E850587

ILLUSTRATION	DESCRIPTION	QTY.	ELECRAFT PART NO.
	U-Cover	1	E850595
	Rear Panel	1	E850598



KXPA100-K Hardware Bag E850585

ILLUSTRATION	DESCRIPTION	QTY.	ELECRAFT PART NO.
	Handle with 2 End Caps	1	E980115
	Foot and Corner Bumper	4	E100456
 Pan Head Screw (typical)	Screw, Pan Head, Black 4-40, 5/16" (7.9 mm)	32	E700294
	Screw, Pan Head, Black 8-32 3/8" (9.5 mm)	2	E700250
	Thumbscrew, 6-32	1	E700070
	Washer, Flat, #6	2	E700067
	Lock Washer, Split Ring, #4	28	E700010
	Spacer, 1/8" (3.2 mm) long	24	E700290

KXPA100 SO239 TMP Cable 2.5" Envelope E850589

ILLUSTRATION	DESCRIPTION	QTY.	ELECRAFT PART NO.
 SO259 – TMP Cable (typical)	SO259 Connector with 2.5" (6.35 cm) cable and TMP connector	1	E850599
	Screw, Pan Head, Black 4-40, 5/16" (7.9 mm)	4	E700294
	Nut, 4-40 with captive star washer	4	E700191

KXPA100 SO239 TMP Cable 4" Envelope E850584

ILLUSTRATION	DESCRIPTION	QTY.	ELECRAFT PART NO.
 <p>SO259 – TMP Cable (typical)</p>	SO259 Connector with 4" (10.2 cm) cable and TMP connector	1	E850600
	Screw, Pan Head, Black 4-40, 5/16" (7.9 mm)	4	E700294
	Nut, 4-40 with captive star washer	4	E700191

KXPA100 Serial Number Envelope E850602

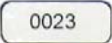
ILLUSTRATION	DESCRIPTION	QTY.	ELECRAFT PART NO.
	Serial Number Label	1	E850602

KXPA100 Bag E850612





 These parts are not required or supplied if the KXATU ATU option is ordered with the kit



ILLUSTRATION	DESCRIPTION	QTY.	ELECRAFT PART NO.
	Front Panel	1	E100459SS
	SO239 Hole Cover	1	E980135

KXAT100 Box E850594

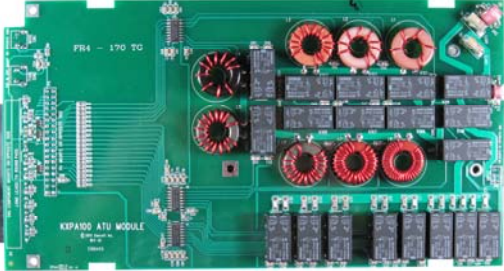

 These parts are supplied only if you ordered the KXAT100 ATU option with your kit.

ILLUSTRATION	DESCRIPTION	QTY.	ELECRAFT PART NO.
	KXPA100 ATU PCB Assy	1	E850572
	KXPA100 Front Panel for ATU	1	E850596

KXAT100 SO239 TMP Cable 4" Envelope E850584

ILLUSTRATION	DESCRIPTION	QTY.	ELECRAFT PART NO.
 SO259 – TMP Cable (typical)	SO259 Connector with 4" (10.2 cm) cable and TMP connector	1	E850600
	Screw, Pan Head, Black 4-40, 5/16" (7.9 mm)	4	E700294
	Nut, 4-40 with captive star washer	4	E700191

KXAT100 Hardware Envelope E850601

ILLUSTRATION	DESCRIPTION	QTY.	ELECRAFT PART NO.
	M-F Standoff, 4-40 3/4" (1.9 cm)	4	E700293
	Switch Cap	2	E980250
	Lock Washer, Split Ring, #4	4	E700010