



ADVANCED MANUAL

HF/VHF/UHF ALL MODE TRANSCEIVER IC-705

This manual describes instructions for advanced features and instructions.
See the BASIC MANUAL that come with the transceiver for precautions and basic operations.

Icom Inc.

INTRODUCTION

1 BATTERY CHARGING

2 ADVANCED OPERATIONS

3 SCOPE OPERATION (ADVANCED)

4 microSD CARD (ADVANCED)

5 VOICE RECORDER FUNCTIONS

6 VOICE TX MEMORY FUNCTION

7 MEMORY OPERATION

8 SCANS

9 OTHER FUNCTIONS

10 Bluetooth® OPERATION

11 WIRELESS LAN OPERATION

12 GPS OPERATION (ADVANCED)

13 D-STAR OPERATION (BASIC)

14 D-STAR OPERATION (ADVANCED)

15 ABOUT THE DV GATEWAY FUNCTION

16 MAINTENANCE (ADVANCED)

17 UPDATING THE FIRMWARE

18 ADVANCED CONNECTIONS

Thank you for choosing this Icom product. This product is designed and built with Icom's state of the art technology and craftsmanship. With proper care, this product should provide you with years of trouble-free operation.

This product combines traditional analog technologies with the new digital technology, Digital Smart Technologies for Amateur Radio (D-STAR), for a balanced package.

ABOUT THE MANUALS

(As of July 2020)

You can use the following manuals to understand and operate this transceiver.

- **Basic Manual (Comes with the transceiver)**
Instructions for basic operations.
- **Advanced Manual (This manual)**
Instructions for advanced operations in English.
- **CI-V Reference Guide (PDF type)**
Describes the control commands used in remote control operation (serial communication with CI-V) in English.
- **About the Share Pictures function (PDF type)**
Describes how to use the Share Pictures function in English.

For Reference

- **HAM Radio Terms (PDF type)**
A glossary of HAM radio terms in English.

TRADEMARKS

Icom, Icom Inc. and the Icom logo are registered trademarks of Icom Incorporated (Japan) in Japan, the United States, the United Kingdom, Germany, France, Spain, Russia, Australia, New Zealand, and/or other countries.

The Bluetooth word mark and logos are registered trademarks owned by the Bluetooth SIG, Inc. and any use of such marks by Icom Inc. is under license.

Adobe, Acrobat, and Reader are either registered trademarks or trademarks of Adobe Systems Incorporated in the United States and/or other countries.

APRS® is a registered trademark of Mr. Bob Bruninga in the U.S.A. and other countries.

Microsoft and Windows are registered trademarks of Microsoft Corporation in the United States and/or other countries.

Google, the Google Logo, Google Play, the Google Play logo, Android, and the Android logo are trademarks of Google, LLC.

All other products or brands are registered trademarks or trademarks of their respective holders.

TABLE OF CONTENTS

ABOUT THE MANUALS	i	Weather channel operation (USA version only)	2-19
TRADEMARKS.....	i	◇ Selecting a Weather channel	2-19
Functions and features of Adobe® Acrobat® Reader® ..vi		◇ Weather alert function	2-19
1 BATTERY CHARGING.....	1-1	3 SCOPE OPERATION (ADVANCED).....	3-1
Battery information.....	1-1	Spectrum Scope screen.....	3-1
◇ Battery life	1-1	◇ Adjusting the sweep speed	3-1
◇ Battery icon	1-1	◇ Adjusting the Reference level.....	3-1
Charging the battery pack.....	1-1	SCOPE SET screen.....	3-2
◇ Charging time	1-1	4 microSD CARD (ADVANCED)	4-1
◇ Charging with a USB cable	1-2	Loading the saved data files	4-1
◇ Charging with the supplied DC power cable ..	1-2	Deleting a data file	4-2
◇ Charging with the optional rapid charger.....	1-3	Displaying the microSD card information ...	4-2
Specifications for the battery charger and battery pack	1-4	Importing or Exporting a CSV format file ...	4-3
◇ BC-202IP2 RAPID CHARGER (optional)	1-4	◇ Importing	4-3
◇ BP-272 Li-ion BATTERY PACK (supplied).....	1-4	◇ Exporting	4-4
2 ADVANCED OPERATIONS	2-1	About the microSD card's folders	4-5
VOX function.....	2-1	5 VOICE RECORDER FUNCTIONS	5-1
◇ Adjusting the VOX function	2-1	Recording a QSO audio.....	5-1
ΔTX function	2-2	◇ Quick recording	5-1
◇ ΔTX monitor function	2-2	◇ Basic recording.....	5-1
Operating CW (ADVANCED)	2-2	Playing back a QSO audio.....	5-2
◇ About the CW Reverse mode.....	2-2	Checking the folder or file information	5-3
◇ Using the Memory Keyer function (KEYER)..	2-3	Deleting files	5-4
◇ Keyer memory edit menu (EDIT).....	2-4	Deleting folders	5-4
◇ Contest number menu (001 SET)	2-5	RECORDER SET screen.....	5-5
◇ Keyer Set menu (CW-KEY SET).....	2-6	PLAYER SET screen	5-6
Operating RTTY (FSK)	2-7	Playing back audio on a PC.....	5-6
◇ Displaying the RTTY DECODE screen	2-7	6 VOICE TX MEMORY FUNCTION.....	6-1
◇ RTTY decoding	2-7	Recording a Voice TX memory	6-1
◇ Twin Peak Filter (TPF).....	2-7	◇ Recording.....	6-1
◇ Transmitting an RTTY memory content.....	2-8	◇ Playing back.....	6-2
◇ Editing an RTTY memory	2-9	Entering a Voice TX memory name	6-2
◇ Turning ON the RTTY log.....	2-10	Transmitting a Voice memory content.....	6-3
◇ Viewing the RTTY log contents	2-10	◇ Transmitting.....	6-3
◇ RTTY DECODE LOG SET screen	2-11	◇ Repeatedly transmitting.....	6-3
◇ RTTY DECODE SET screen	2-12	◇ Adjusting the output level	6-4
Tone squelch operation.....	2-13	VOICE TX SET screen	6-4
DTCS code squelch operation	2-14	7 MEMORY OPERATION.....	7-1
Repeater operation	2-15	Memory channels.....	7-1
◇ Checking the repeater input signal.....	2-15	Selecting a memory group.....	7-1
◇ Setting the repeater tone frequency.....	2-16	Entering Memory channel contents	7-1
◇ 1750 Hz tone burst.....	2-16		
Duplex operation.....	2-17		
Data communication	2-17		
About the 5 MHz frequency band operation (USA version only)	2-18		

TABLE OF CONTENTS

Selecting a Memory channel.....	7-2	Screen Capture function	9-5
◇ Selecting with MULTI	7-2	◇ Setting the Screen Capture function	9-5
◇ Selecting on the MEMORY screen.....	7-2	◇ Capturing a screen	9-5
Selecting a Call channel	7-2	◇ Viewing the captured screen	9-5
Copying the Memory channel contents.....	7-3	Entering DTMF code.....	9-6
◇ Copying to the VFO.....	7-3	Transmitting the DTMF code	9-6
◇ Copying to another Memory channel	7-3	◇ Transmitting a DTMF code.....	9-6
Entering a group/Memory name	7-4	◇ Transmitting a DTMF code (Direct Input).....	9-6
◇ Entering a group name.....	7-4	◇ Selecting the DTMF transmit speed	9-7
◇ Entering a Memory name	7-4	Home Channel function	9-7
Clearing a Memory channel	7-5	◇ Home Channel setting.....	9-7
MEMORY screen	7-5	◇ Home CH Beep function.....	9-7
Memo Pad.....	7-6	Share Pictures function.....	9-7
◇ Saving the contents into a Memo Pad.....	7-6	Setting the Opening picture	9-8
◇ Calling up the Memo Pads	7-6		
◇ MEMO PAD screen	7-6		
8 SCANS	8-1	10 Bluetooth® OPERATION	10-1
Scan types	8-1	Bluetooth® operations	10-1
Preparation	8-1	Turning ON the Bluetooth® function.....	10-1
◇ Squelch status.....	8-1	Connecting to a Bluetooth® headset.....	10-2
SCAN screen	8-2	Bluetooth® Settings	10-3
SCAN SET screen	8-3	◇ AF Output.....	10-3
Programmed scan and Fine Programmed scan	8-4	◇ Headset Function Select	10-3
◇ Programmed scan operation.....	8-4	◇ About the Icom headset	10-4
Entering Scan Edges	8-5	Pairing with an Android™ device	10-5
Memory scan	8-6	Disconnecting a Bluetooth® device from the transceiver	10-6
◇ Memory scan operation.....	8-6	Deleting a Bluetooth® device from the pairing list.....	10-6
Select Memory scan	8-7	Editing the Bluetooth® unit name	10-7
◇ Setting the Select Memory channels.....	8-7	Initializing the Bluetooth® unit	10-7
◇ Select Memory scan operation.....	8-7	The maximum number of paired devices.	10-7
Mode Select scan	8-8		
◇ Mode Select scan operation.....	8-8	11 WIRELESS LAN OPERATION.....	11-1
Δ F scan and Fine Δ F scan	8-9	Wireless LAN operation	11-1
◇ Δ F scan operation.....	8-9	Turning ON the Wireless LAN function ...	11-1
Temporary Skip function	8-10	Connecting to a Wireless Access Point (AP)	11-2
9 OTHER FUNCTIONS	9-1		
About “USB SEND/Keying”	9-1	12 GPS OPERATION (ADVANCED).....	12-1
Protection function	9-1	GPS TX mode and TX format types	12-1
Measuring SWR.....	9-2	Differences between older models.....	12-1
◇ Spot measurement.....	9-2	When a received signal contains position data	12-2
◇ Plot measurement	9-3		
NTP function	9-4		
◇ Using the NTP Time Synchronize function....	9-4		
◇ Using the NTP function	9-4		

TABLE OF CONTENTS

Checking your location.....	12-2	About the DR function.....	13-2
◇ Displaying Position Data	12-2	Ways to Communicate	
◇ GPS POSITION screens		with the DR function.....	13-2
and their meanings.....	12-3	Enter your call sign (MY)	
◇ About the RX screen	12-4	into the transceiver.....	13-3
◇ About the Course	12-5	Register your call sign	
◇ About the Grid Locator	12-5	at a gateway repeater	13-4
◇ Changing the GPS Memory or Alarm	12-5	Making a Simplex call	13-5
◇ Changing the Compass Direction.....	12-6	Accessing repeaters	13-6
◇ Saving your own		Receiving	13-7
or a received station's position	12-6	Capturing a call sign	13-8
Checking GPS information		Making a Local CQ call	13-8
(Sky view screen).....	12-7	Making a Gateway CQ call	13-9
Transmitting D-PRS data	12-8	Calling an individual station	13-9
◇ D-PRS	12-8	Saving to Memory channels.....	13-10
◇ Operating in the D-PRS mode.....	12-8	About Reflectors	13-11
◇ Displayed items	12-9	◇ What is a reflector?	13-11
◇ Setting D-PRS Position (Mobile/Base).....	12-10	◇ Unlinking a reflector.....	13-11
◇ Setting D-PRS Object/Item.....	12-11	◇ Linking to a reflector	13-12
◇ Setting D-PRS Weather	12-12	◇ Using a reflector	13-13
◇ Weather station transmission	12-13	◇ Reflector Echo Testing	13-13
◇ Confirming the weather data input	12-13	◇ Requesting repeater information	13-14
◇ Application setting	12-13	Updating the repeater list.....	13-15
◇ About the weather data content	12-14	When receiving no reply	13-17
◇ Displaying your location			
using mapping software	12-15		
Transmitting NMEA data	12-17		
◇ Setting the GPS data sentence	12-17		
◇ Setting a GPS message	12-18		
GPS Automatic Transmission	12-18		
GPS Memory	12-19		
◇ Adding a GPS Memory.....	12-19		
◇ Entering the GPS Memory group name	12-21		
◇ Deleting GPS Memory.....	12-22		
◇ Rearranging the display order			
of the GPS data.....	12-23		
GPS Alarm	12-24		
◇ Setting the GPS Alarm function to All Memories			
(all GPS Memories).....	12-25		
◇ Setting the GPS Alarm function to RX			
(a caller station).....	12-26		
GPS Logger function.....	12-27		
◇ GPS Logger operating outline	12-27		
◇ Confirming the GPS Logger function.....	12-27		
◇ Setting the GPS record interval.....	12-27		
◇ Setting the GPS record sentence.....	12-28		
◇ Viewing the log data on a PC Map	12-29		
GPS SET	12-31		
13 D-STAR OPERATION (BASIC).....	13-1	14 D-STAR OPERATION (ADVANCED)	14-1
Unique features of D-STAR	13-1	"FROM" (Access repeater) setting	14-1
What is D-STAR?	13-1	◇ Using your transceiver's repeater list	14-2
		◇ Using the DR scan	14-3
		◇ Using the Near Repeater Search function...	14-4
		◇ Using TX History	14-5
		"TO" (Destination) setting.....	14-6
		◇ Making a "Local CQ" (Local Area) call.....	14-7
		◇ Making a "Gateway CQ" (Gateway) call.....	14-7
		◇ Using "Your Call Sign"	14-7
		◇ Using RX History	14-8
		◇ Using TX History	14-8
		◇ Directly entering (UR).....	14-9
		◇ Directly entering (RPT).....	14-9
		REPEATER DETAIL screen.....	14-10
		Message operation	14-11
		◇ Entering a TX message.....	14-11
		◇ Transmitting a message	14-11
		◇ Deleting a TX message	14-11
		Viewing received call signs	14-12
		◇ Viewing the call signs	
		on the RX History screen	14-12
		BK mode communication	14-14
		EMR communication.....	14-15

TABLE OF CONTENTS

◇ Adjusting the EMRAF level.....	14-15	Setting up a network	15-4
Automatic DV detection	14-16	◇ When connecting your device to the Internet using a router	15-6
Automatic Reply function	14-17	◇ When connecting your device to the Internet using a cellular system.....	15-8
◇ Recording an Auto Reply message.....	14-18	◇ When connecting your device to the Internet using a mobile router.....	15-9
◇ Auto Position Reply function	14-19	Setting up the device	15-10
Data communication	14-20	◇ When using the Internal Gateway function	15-10
◇ Connection	14-20	◇ When using the RS-MS3W software.....	15-12
◇ Data communication application setting....	14-20	◇ When using the RS-MS3A.....	15-13
◇ Sending data	14-20	Terminal mode operation	15-14
◇ DV Fast Data function	14-21	◇ Setting the Terminal mode.....	15-14
Digital squelch functions	14-22	◇ Operating in the Terminal mode	15-15
◇ The Digital Call Sign squelch setting.....	14-22	Access Point mode operation	15-16
◇ The Digital Code Squelch setting.....	14-22	◇ Setting the Access Point mode.....	15-16
Repeater list.....	14-23	◇ Making a Gateway call through the Access Point transceiver.....	15-17
◇ Repeater list contents.....	14-23	Troubleshooting	15-21
Entering new information into the repeater list	14-24	◇ Error icons of the transceiver	15-21
◇ Required items for the communication cases.....	14-24	◇ Troubleshooting for the Terminal mode operation.....	15-22
◇ Entering new information into the repeater list.....	14-25	◇ Troubleshooting for the Access Point mode operation.....	15-24
◇ Editing repeater data	14-28	◇ Error messages of the RS-MS3W and the RS-MS3A.....	15-26
◇ Deleting repeater data.....	14-29	16 MAINTENANCE (ADVANCED).....	16-1
◇ Rearranging the display order of the repeaters	14-30	Cloning.....	16-1
◇ Adding new repeater information from RX History	14-30	Touch screen calibration function.....	16-3
◇ Skip setting for the DR scan.....	14-31	17 UPDATING THE FIRMWARE.....	17-1
◇ Entering or editing a repeater group name	14-32	General	17-1
Your Call Sign	14-33	◇ About updating the firmware	17-1
◇ Entering Your Call Sign	14-33	◇ Checking the firmware version.....	17-1
◇ Deleting Your Call Sign.....	14-34	◇ Preparation.....	17-2
◇ Rearranging the display order of Your Call Signs	14-34	◇ Unzipping the firmware folder.....	17-2
Manually setting Call Signs.....	14-35	Updating the firmware.....	17-3
Are your settings correct?	14-36	18 ADVANCED CONNECTIONS	18-1
Using the RS-MS1A.....	14-37	FSK and AFSK connections.....	18-1
◇ Required items	14-37		
◇ Installing the application.....	14-37		
◇ When using a USB cable	14-37		
◇ When using the Bluetooth function.....	14-38		
15 ABOUT THE DV GATEWAY FUNCTION 15-1			
About the DV Gateway function.....	15-1		
When using the External Gateway function	15-2		
About the Terminal and Access Point (AP) Call sign	15-3		
◇ When operating in the Terminal mode.....	15-3		
◇ When operating in the AP mode.....	15-3		

FUNCTIONS AND FEATURES OF ADOBE® ACROBAT® READER®

The following functions and features can be used with Adobe® Acrobat® Reader®.

- **Keyword search**

Click “Find (Ctrl+F)” or “Advanced Search (Shift+Ctrl+F)” in the Edit menu to open the search screen. This is convenient when searching for a particular word or phrase in this manual.
 ① The menu screen may differ, depending on the Adobe Acrobat Reader version.

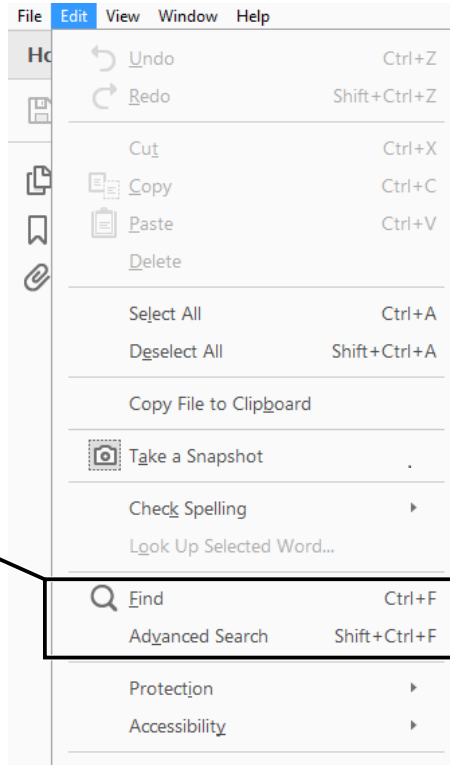

Click to open the find or search screen or advanced search screen.

- **Find screen**

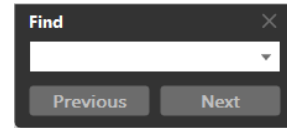

- **Advanced search screen**

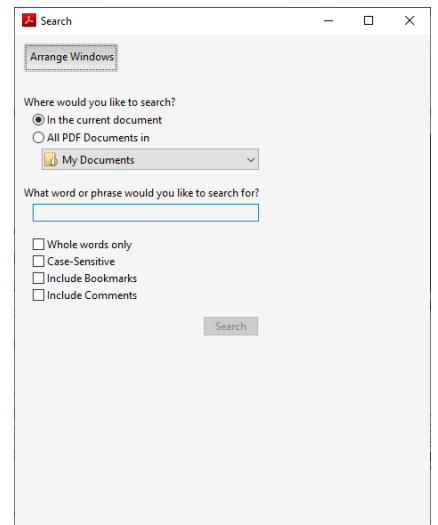

- **Printing out the desired pages.**

Click “Find (Ctrl+F)” or “Advanced Search (Shift+Ctrl+F)” in the Edit menu to open the search screen. This is convenient when searching for a particular word or phrase in this manual.
 ① The menu screen may differ, depending on the Adobe Acrobat Reader version.
 ① Select “A4” size to print out the page in the original manual size.

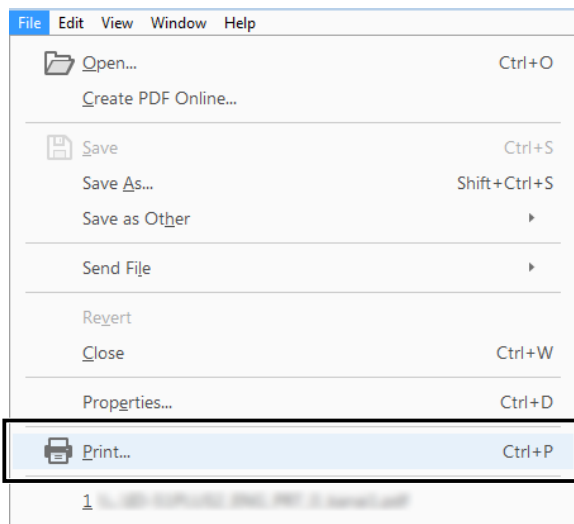

- **Read Out Loud feature.**

The Read Out Loud feature reads aloud the text in this PDF. Refer to the Adobe Acrobat Reader Help for the details.
 (This feature may not be usable, depending on your PC environment including the operating system.)

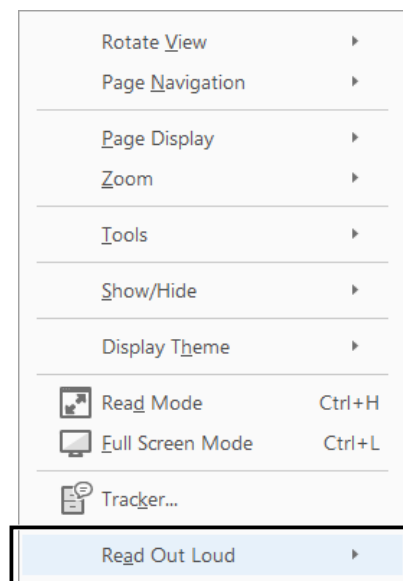

① The screen may differ, depending on the Adobe Acrobat Reader version.

1. BATTERY CHARGING





Battery information

◇ Battery life

After the charging is completed, the battery life will be approximately 3 hours when:

- Operating mode: FM
- Power save setting: Auto (Short)
- Duty cycle: TX : RX : Standby = 1 : 1: 8
(based on operating style)

◇ Battery icon

Icon	Battery status
	The battery is being charged.
	The battery has sufficient charge.
	The battery is exhausted to some extent.
	The battery is nearing exhaustion.
Blinking	The battery is almost fully exhausted.
No icon	When a DC power supply (13.8 V DC) is connected, the battery is not being charged because: <ul style="list-style-type: none"> • The battery is completely charged. • "Charging (Power ON)" is set to "OFF."

① When the transceiver's display is OFF, the charging indicator lights orange while charging.

NOTE: BE SURE to replace the battery pack with a new one approximately five years after manufacturing, even if it still holds a charge. The material inside the battery cells will become weak after a period of time, even with little use. The estimated number of times you can charge the pack is between 300 and 500. Even when the pack appears to be fully charged, the operating time of the transceiver may become short when:

- Approximately five years have passed since the pack was manufactured.
- The pack has been repeatedly charged.

TIP: Keep the battery terminals clean. It's a good idea to occasionally clean them.

Charging the battery pack

NOTE: Prior to using the transceiver for the first time, the battery pack must be fully charged for optimum life and operation.

① To charge the battery pack while the transceiver is ON, set the following item to "ON" (default).

MENU » **SET > Function > Charging (Power ON)**

To charge the battery pack that is attached to the transceiver:

- Connect a power source with a USB cable. (p. 1-2)
- Connect a DC power supply with the supplied DC power cable. (p. 1-2)

To charge the battery pack that is not attached to the transceiver, use the optional rapid charger. (p. 1-3)

◇ Charging time

A DC power supply	A USB cable	BC-2021P2 (Optional)
Approximately 2.3 hours* ¹	Approximately 3.2 hours* ^{1*2}	Approximately 2 hours

*¹ The transceiver is OFF while charging.

*² When using a 2 A output USB port and a cable that is compatible with the rapid charging.

1. BATTERY CHARGING

Charging the battery pack

◇ Charging with a USB cable

You can charge the battery pack with a USB cable.

NOTE:

- You may not be able to charge:
 - Depending on your USB cable or power adapter.
 - When using a USB hub, or connected to a low output USB port.
- Charging time may differ, depending on the USB port.
- To use a mobile device or a PC as an external power source, set the following item to "ON" (default).
[MENU] » [SET > Function > USB Power Input (Phone, Tablet, PC)]
- The battery pack is used as a power source while transmitting, even when an external power source is connected. Therefore, you cannot transmit if the battery pack is exhausted.

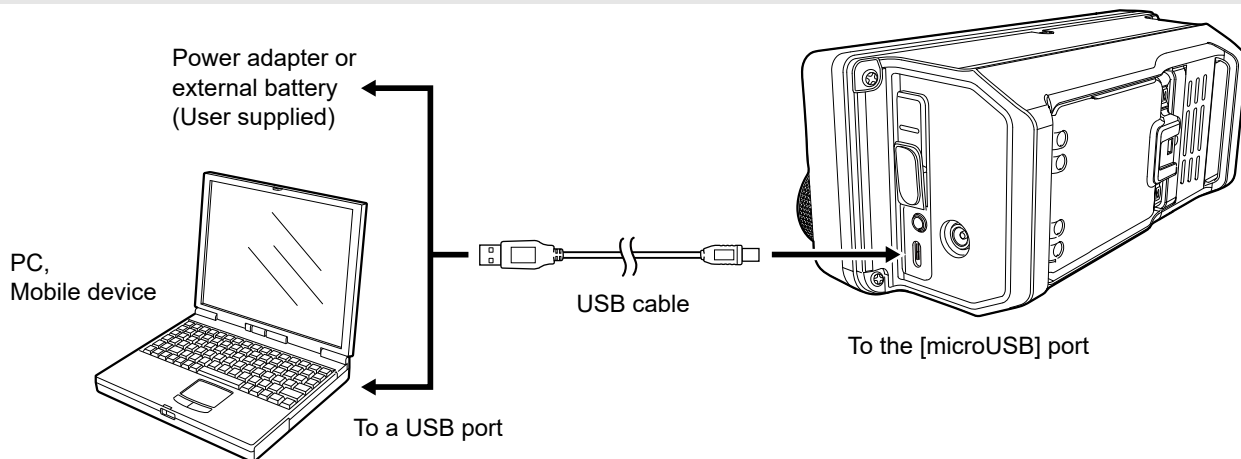

◇ Charging with the supplied DC power cable

You can charge the battery pack with the supplied DC power cable.

① When connecting a DC power cable, the transceiver needs:

- DC 13.8 V (Capacity: At least 5 Amps)
- A power supply with an over current protective line, and low voltage fluctuation or ripple.

NOTE:

- Confirm that the transceiver is OFF before connecting the DC power cable.
- You cannot connect the optional cigarette lighter cable (CP-22 and CP-23L) to the IC-705's [DC 13.8 V] jack.
- If the applied voltage from the connected power source decreases, the battery pack is not charged, and the battery pack is used as a power source while transmitting. In this case, you cannot transmit if the battery pack is exhausted.

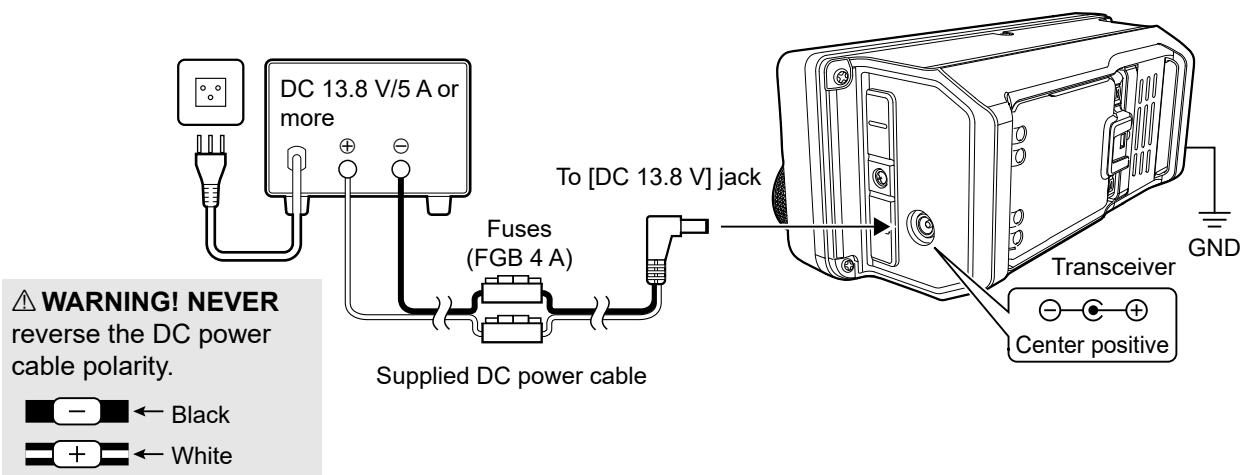

1. BATTERY CHARGING

Charging the battery pack

◇ Charging with the optional rapid charger

The optional BC-202IP2 RAPID CHARGER rapidly charges the battery pack.

- ① The charging indicator lights orange while charging, and lights green when charging is completed.
- ① When about 90% of the battery capacity is charged, the BC-202IP2 stops charging and the charging indicator lights green. Therefore, the battery life will be a little shorter than when charging with the transceiver.

Approximate charging time: 2 hours

Charging note

- ⚠ **DANGER! NEVER** use a battery pack that is not manufactured or approved by Icom.
- The BC-202IP2 RAPID CHARGER can only charge the BP-271 or BP-272 Li-ion BATTERY PACK. Other types of rechargeable batteries, Ni-Cd or Ni-MH cannot be charged.
- If the charging indicator blinks orange, there may be a problem with the battery pack or charger. Contact your dealer if you have problems charging a new battery pack.
- **NEVER** use other than specified cable.

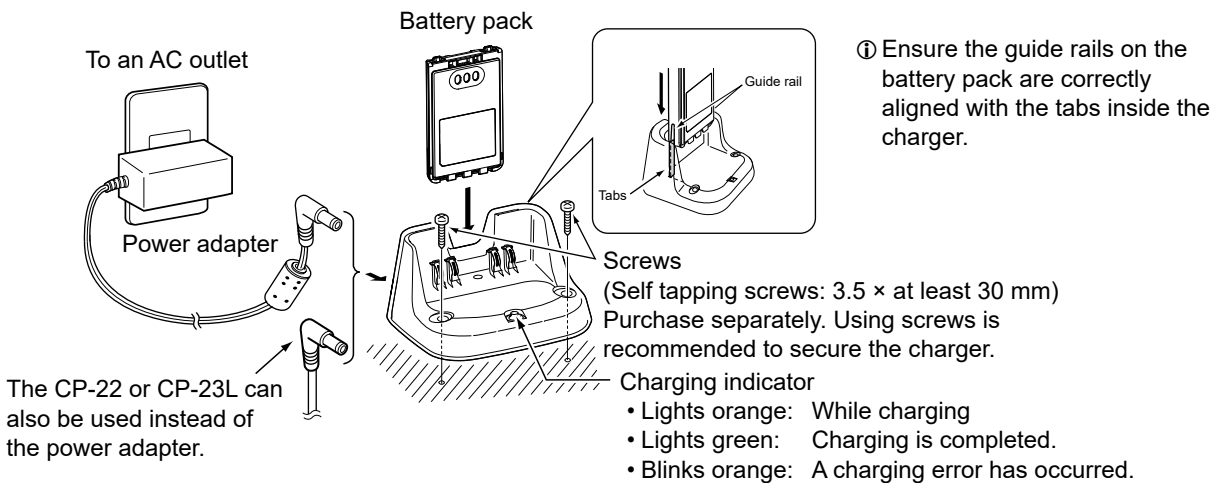

1. BATTERY CHARGING

Specifications for the battery charger and battery pack

◇ **BC-202IP2 RAPID CHARGER (optional)**

- Power source requirement: 12 V ~ 16 V DC or the specified Icom power adapter (BC-123S)
- Charging temperature range: 10°C ~ 40°C, 50°F ~ 104°F
- Weight (approximate): 105 g, 3.7 oz
(without power adapter)
- Dimensions: 88.0 (W) × 47.5 (H) × 72.5 (D) mm, 3.5 (W) × 1.9 (H) × 2.9 (D) inches
(projections are not included)

◇ **BP-272 Li-ion BATTERY PACK (supplied)**

- Voltage: 7.4V
- Discharge Capacity: 1880 mAh (minimum)
- Usable temperature range: -20°C ~ +60°C, -4°F ~ +140°F
- Charging temperature range: 0°C ~ 40°C, 32°F ~ 104°F
- Storage temperature range: -20°C ~ +50°C, -4°F ~ +122°F (within a month)
-20°C ~ +35°C, -4°F ~ +95°F (within 3 months)
-20°C ~ +20°C, -4°F ~ +68°F (within a year)
- Dimensions: 58 (W) × 86.9 (H) × 14.2 (D) mm, 2.3 (W) × 3.4 (H) × 0.6 (D) inches
(projections are not included)

① All stated specifications are typical and subject to change without notice or obligation.

2. ADVANCED OPERATIONS

VOX function

SSB, AM, FM, and DV modes

The Voice-Operated Transmission (VOX) function switches between transmit and receive with your voice. This function enables hands-free operation.

Push **VOX** to turn the VOX function ON or OFF.

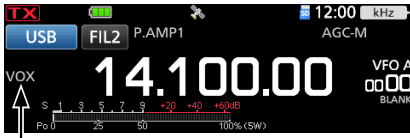

The VOX function is ON.

◇ Adjusting the VOX function

Before using the VOX function, adjust the following items.

- VOX GAIN
- ANTI VOX
- DELAY
- VOICE DELAY

1. Hold down **VOX** for 1 second.
2. Touch the item to adjust.
(Example: ANTI VOX)

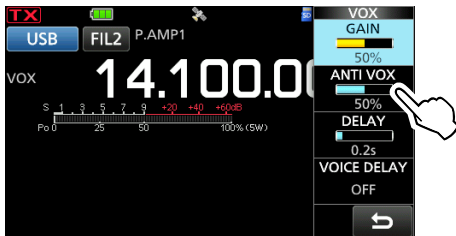

3. Rotate **MULTI** to adjust the item.
① Touching VOICE DELAY selects “SHORT,” “MID,” “LONG,” or “OFF.”
4. To close the VOX menu, push **MULTI**.

VOX GAIN (Default: 50%)

Adjusts the transmit/receive switching threshold level to between 0% and 100% for VOX operation. Higher values make the VOX function more sensitive to your voice.

ANTI VOX (Default: 50%)

Adjusts the ANTI VOX level to between 0% and 100% to prevent unwanted VOX activation from the speaker or other sounds. Higher values make the VOX function less sensitive.

DELAY (Default: 0.2s)

Adjusts the DELAY to between 0 and 2.0 seconds. Set for a convenient interval for normal pauses in a speech before returning to receive.

VOICE DELAY (Default: OFF)

Sets the VOICE DELAY to prevent cutting off your voice when switching to transmit.

- Select “SHORT,” “MID,” “LONG,” or OFF.

2. ADVANCED OPERATIONS

Δ TX function

The Δ TX function shifts your transmit frequency up to ± 9.99 kHz without shifting the displayed frequency.

1. Push **[RIT/ Δ TX]**.

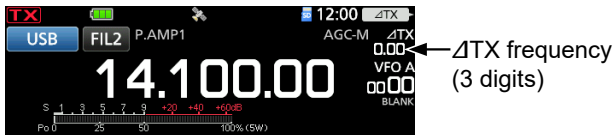

- The Δ TX function turns ON.
- ① If the RIT function turns ON, hold down **[RIT/ Δ TX]** for 1 second.
 - ① While using the Fine Tuning function (Basic Manual), the Δ TX frequency is displayed in 4 digits, instead of 3.
 - ① Pushing **[RIT/ Δ TX]** again turns OFF the Δ TX function.
2. Rotate **[\odot MULTI]** to set the Δ TX frequency to match the received station's frequency up to ± 9.99 kHz.

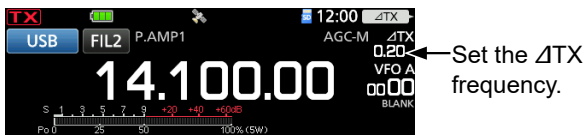

- ① You can reset the Δ TX frequency to "0.00" by holding down **[\odot MULTI]** for 1 second.
3. After communicating, push **[RIT/ Δ TX]** to turn OFF the Δ TX function.

\diamond Δ TX monitor function

When the Δ TX function is ON, you can directly monitor the operating frequency by holding down **[XFC]**.

- ① While monitoring, the settings for the Noise Reduction, Notch filter, and Twin PBT are temporarily turned OFF.

Operating CW (ADVANCED)

\diamond About the CW Reverse mode

The CW-R (CW Reverse) mode reverses the receive Beat Frequency Oscillator (BFO) to receive CW signals.

Use this when interfering signals are near the desired signal, and you want to use the CW-R to reduce interference.

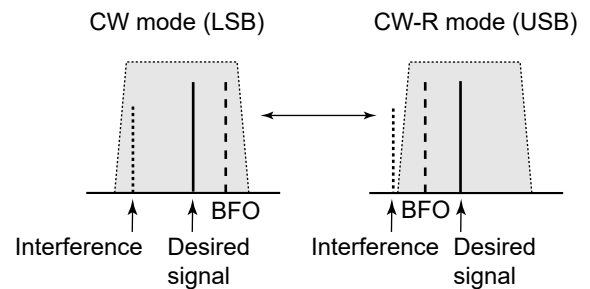

TIP: Reversing the carrier point

The carrier point of the CW mode is LSB by default.

You can change it to USB in the following menu.

[MENU] » **[SET > Function > CW Normal Side]**

- ① When this setting is set to "USB," the CW and CW-R modes are reversed.

2. ADVANCED OPERATIONS

Operating CW (ADVANCED)

◇ Using the Memory Keyer function (KEYER)

You can send preset characters using the Memory Keyer function.

Sending

1. Display the KEYER screen.

MENU » **KEYER**

- ① The [KEYER] key is displayed only in the CW mode.
2. Push **BK-IN** to turn ON the Break-in function. (Basic Manual)
3. Touch a Memory Keyer key between [M1] and [M8]. (Example: [M1])



- The touched memory contents are sent.
4. To repeatedly send the memory contents, touch the Memory Keyer key for 1 second.

Repeat icon





- ① The memory contents will be repeatedly sent, according to the setting in “Keyer Repeat Time.”
- ① To stop sending, touch the Memory Keyer key again.

Key	Action	
M1 ~ M8	Touch	Sends the memory contents.
	Touch for 1 second	 is displayed and repeatedly sends the memory contents. You can change the repeat interval setting in “Keyer Repeat Time” in the CW-KEY SET menu. (p. 2-6)
-1 001	Reduces the contest number counter by 1 (001). • You can change or reset the number in “Present Number” in the KEYER 001 menu. (p. 2-5)	
EDIT/SET	Displays the EDIT/SET screen.	

Count-up trigger

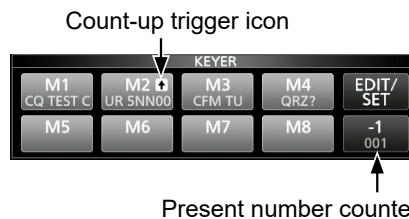
The Count-up trigger enables the serial number to be automatically increased after each complete serial number exchange is sent. (Default: M2)



- ①  is displayed on the Memory Keyer set to the Count-up trigger.
- ① You can change the Count-up trigger setting in the KEYER 001 menu. (p. 2-5)

Preset Keyer memory contents

Keyer memory	Contents
M1	CQ TEST CQ TEST DE ICOM ICOM TEST
M2	UR 5NN 001 BK
M3	CFM TU
M4	QRZ?

- ① “001” is the CW contest number.
If you want to set the Count-up trigger to a different keyer, delete the “*” (asterisk) from the Memory Keyer M2. (p. 2-4)

When an external keypad is connected:

You can transmit the preset contents in the Keyer memory (M1 ~ M8) from an external device by setting the “External Keypad,” and then connecting an external keypad to [KEY] on the IC-705.

MENU » **SET** > Connectors > **External Keypad**

2. ADVANCED OPERATIONS

Operating CW (ADVANCED)

◆ Keyer memory edit menu (EDIT)

You can edit the Keyer memory contents.

① You can use up to a total of 8 Memory Keyers (M1 to M8), and you can enter up to 70 characters in each memory.

Example: Entering “QSL TU DE JA3YUA TEST” to M3

1. Display the KEYER MEMORY screen in the CW mode.

MENU » **KEYER > EDIT/SET > EDIT**

2. Touch “CFM TU” for 1 second.

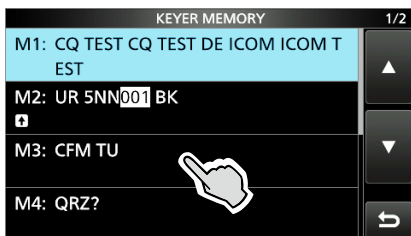

3. Touch “Edit.”

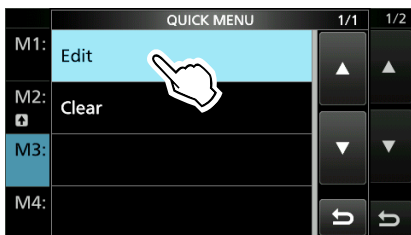

4. Touch [CLR] on the Keyer Memory keyboard until the preset contents are cleared.

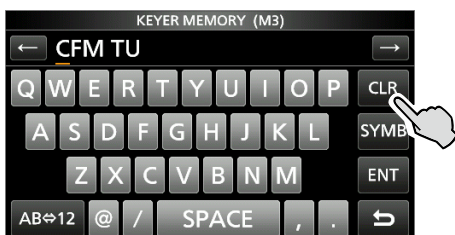

5. Enter “QSL TU DE JA3YUA TEST,” and then touch [ENT] to save.

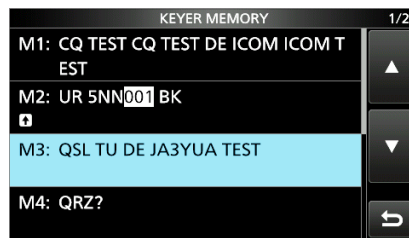

6. To close the KEYER MEMORY screen, push **EXIT**.

Selectable characters	
Alphabets	ABCDEFGHIJKLMNOPQRSTUVWXYZ
Symbols	/ ? ^ . , @ *
Numbers	1234567890

About the symbols

- Enter the “^” to send a string of characters with no intercharacter space. Put “^” before a text string such as ^AR, and the string “ar” is sent with no space.
- Enter the “*” (asterisk) to insert the CW contest number. The number automatically advances by 1. You can use this for only 1 Memory keyer at a time. The “*” is used in Memory Keyer M2 by default.

2. ADVANCED OPERATIONS

Operating CW (ADVANCED)

◇ Contest number menu (001 SET)

You can set the number style, Count-up trigger, and preset number.

1. Display the KEYER 001 screen in the CW mode.

MENU » **KEYER > EDIT/SET > 001 SET**

2. Touch the item to set.
(Example: Number Style)

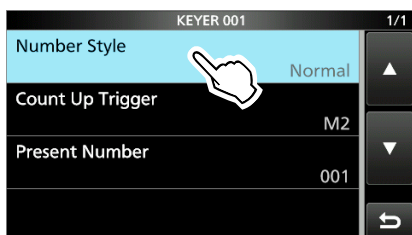

3. Touch the option to set.
(Example: 190→ANO)

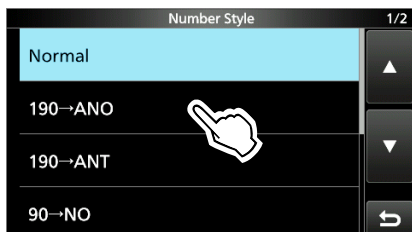

- Returns to the KEYER 001 screen.

4. To close the KEYER 001 screen, push **EXIT**.

TIP: You can set each item to its default by touching the item for 1 second, and then touching "Default" on the QUICK MENU screen.

Number Style (Default: Normal)

Sets the numbering system used for contest (serial) numbers— normal or short morse numbers.

- Select Normal, 190→ANO, 190→ANT, 90→NO, or 90→NT.

Count Up Trigger (Default: M2)

Selects which of the 8 memories will contain the contest serial number exchange.

- Select between M1 ~ M8.

Present Number (Default: 001)

Sets the current number for the Count-up trigger.

- Set to between 001 ~ 9999.

2. ADVANCED OPERATIONS

Operating CW (ADVANCED)

◇ Keyer Set menu (CW-KEY SET)

In this screen, you can set the memory keyer repeat time, dash weight, paddle specifications, key type, and so on.

1. Display the CW-KEY SET screen in the CW mode.

[MENU] » **KEYER > EDIT/SET > CW-KEY SET**

2. Touch the item to set.
(Example: Side Tone Level)

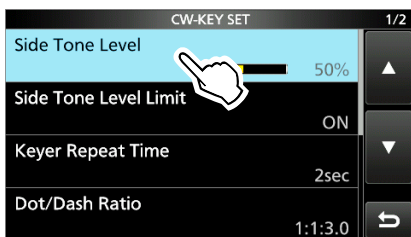

3. Touch the option to set. (Example: 80%)

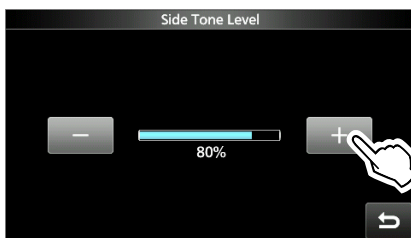

4. To close the CW-KEY SET screen, push **[EXIT]**.

TIP: You can set each item to its default by touching the item for 1 second, and then touching "Default" on the QUICK MENU screen.

Side Tone Level (Default: 50%)

Adjusts the CW side tone output level.

- Adjust to between 0 ~ 100%.

Side Tone Level Limit (Default: ON)

Turns the CW side tone level limit ON or OFF. This function disables the CW side tone when you increase AF GAIN above the side tone level.

Keyer Repeat Time (Default: 2sec)

Sets the time between Memory keyer transmissions.

- Set to between 1 ~ 60 seconds.

① After transmitting a Memory keyer contents, the transmission is repeated after the set time period.

① is displayed, even between transmissions.

Dot/Dash Ratio (Default: 1:1:3.0)

Sets the dot/dash ratio.

- Set to between 1:1:2.8 ~ 1:1:4.5 in 0.1 steps.

Keying weight example: Morse code "K"

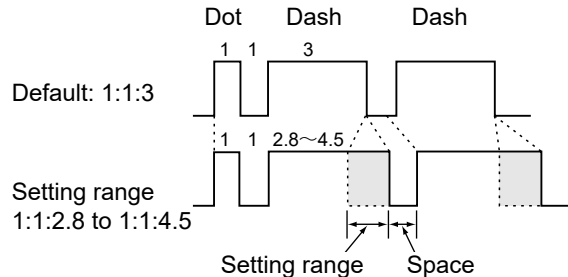

Rise Time (Default: 4ms)

Sets the rise time of the transmitted CW envelope.

- Set to 2, 4, 6, or 8 milliseconds.

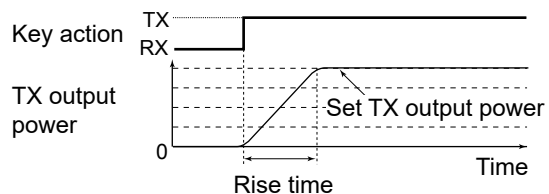

Paddle Polarity (Default: Normal)

Sets the paddle dot-dash polarity to Normal or Reverse.

- Normal: Right = dash, Left = dot
- Reverse: Right = dot, Left = dash

Key Type (Default: Paddle)

Sets the key type for the [KEY] jack on the side panel.

- Set to Straight, Bug, or Paddle.

① When using an external Elec-keyer, select "Straight."

MIC Up/Down Keyer (Default: OFF)

Selects whether or not to use the keys on the microphone as a CW key.

- OFF: Do not use the microphone keys as a CW key.

- ON (UP/DOWN):

Use the [▲]/[▼] keys as a CW key.

- ON (A/B): Use the [A]/[B] keys as a CW key.

① The microphone keys do not work as a "squeeze key."

① When "ON" is selected, you cannot use the function that is assigned to each key.

Operating RTTY (FSK)

The IC-705 has a built-in RTTY decoder and encoder. Using contents set in the RTTY TX memory, you can do basic RTTY operations without using an external device or software.

◇ Displaying the RTTY DECODE screen

With the built-in demodulator and decoder, received RTTY characters are displayed on the RTTY DECODE screen.

[MENU] » **[DECODE]**

RTTY DECODE screen

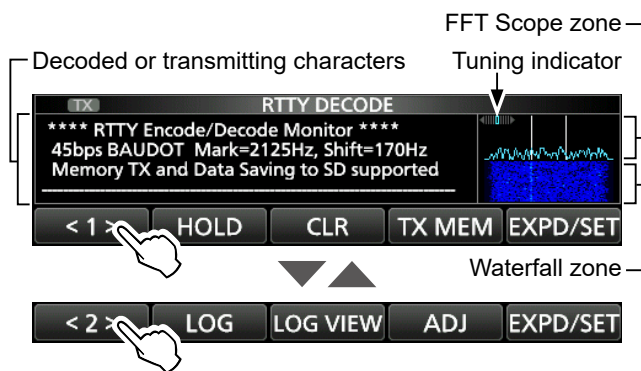

Key	Action	
< 1 > < 2 >	Selects the Function menus.	
HOLD	Turns the Hold function ON or OFF. • [HOLD] is displayed, and the RTTY DECODE screen stops.	
CLR	Clears the displayed characters. • While the Hold function is ON, this clears the characters and cancels the Hold function.	
TX MEM	Opens the RTTY MEMORY screen. • Sending the RTTY MEMORY RT1 ~ RT8.	
LOG	Displays the RTTY DECODE LOG screen. • You can start or stop logging, and select the file type and the time stamp.	
LOG VIEW	Displays the RTTY DECODE LOG VIEW screen. • You can check the saved RTTY log files.	
ADJ	Opens the THRESHOLD screen. • You can adjust the threshold level.	
EXPD/SET	Touch	Selects the Expanded or Normal screen.
	Touch for 1 second	Displays the SCOPE SET screen.

◇ RTTY decoding

Rotate **[MAIN DIAL]** to tune a signal.



① Information

- Aim for a symmetrical wave form, and be sure the peak points align with the mark (2125 Hz) and shift (170 Hz) frequency lines in the FFT scope.
- Tune to where both “◀” and “▶” are displayed in the tuning indicator.
- The S-meter displays the signal strength, when a signal is received.
- If you are receiving an RTTY signal but cannot decode correctly, try the RTTY-R (reverse) mode.

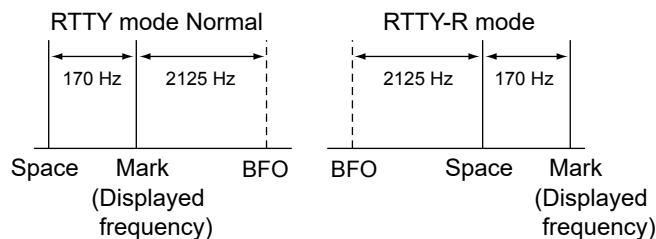

TIP: If you cannot receive, change the following settings.

[MENU] » **[SET > Function > RTTY Mark Frequency]**

[MENU] » **[SET > Function > RTTY Shift Width]**

◇ Twin Peak Filter (TPF)

The Twin Peak Filter (TPF) changes the audio frequency response by boosting the mark and space frequencies for better reception of RTTY signals, or for decoding the AF output signal on a PC.

1. Push **[MULTI]** to open the Multi-function menu.
2. Touch [TPF].
① Touching [TPF] turns the Twin Peak Filter function ON or OFF.
3. To close the Multi-function menu, push **[MULTI]**.

NOTE: When you are using the Twin Peak Filter, the received audio output may increase. This is not a malfunction.

2. ADVANCED OPERATIONS

Operating RTTY (FSK)

◇ Transmitting an RTTY memory content

You can transmit the preset characters on the RTTY MEMORY screen.

① You can edit the contents by touching [EDIT] on the RTTY MEMORY screen.

1. Display the RTTY DECODE screen in the RTTY mode.

[MENU] » **[DECODE]**

2. Touch [TX MEM].



3. Touch an RTTY memory between [RT1] and [RT8] to transmit. (Example: RT1)



Transmitting



Transmitting contents are displayed.

- The TX status indicator lights red and the Po meter swings.
- ① To cancel the transmission and to return to the RTTY DECODE screen, push **[EXIT]**.
 - ① After transmitting, automatically returns to receive.

Memory	Preset characters by default
RT1	↓ DE ICOM ICOM K ↓
RT2	↓ DE ICOM ICOM ICOM K ↓
RT3	↓ QSL UR 599-599 BK ↓
RT4	↓ QSL DE ICOM ICOM UR 599-599 BK ↓
RT5	↓ 73 GL SK ↓
RT6	↓ CQ CQ CQ DE ICOM ICOM ICOM K ↓
RT7	↓ MY TRANSCEIVER IS IC-705 & ANTENNA IS A TRIBAND WHIP. ↓
RT8	↓ MY RTTY EQUIPMENT IS INTERNAL FSK UNIT & DEMODULATOR OF THE IC-705. ↓

When an external keypad is connected:

You can transmit the preset contents in the RTTY memory (RT1 ~ RT8) from an external device by setting the “External Keypad,” and then connecting an external keypad to [KEY] on the IC-705.

[MENU] » **[SET > Connectors > External Keypad]**

2. ADVANCED OPERATIONS

Operating RTTY (FSK)

◇ Editing an RTTY memory

You can edit the characters in the RTTY memories. You can save and transmit 8 RTTY memories (RT1 ~ RT8) for often-used RTTY messages. Each RTTY memory can contain up to 70 characters.

Example: Editing the content in RT2

1. Display the RTTY DECODE screen in the RTTY mode.

MENU » **DECODE**

2. Touch [TX MEM].



3. Touch [EDIT].



4. Touch the memory for 1 second.

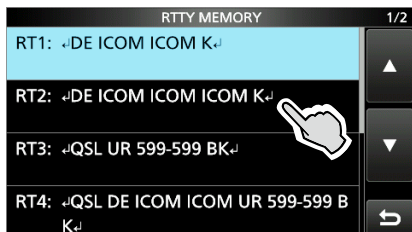

5. Touch "Edit."

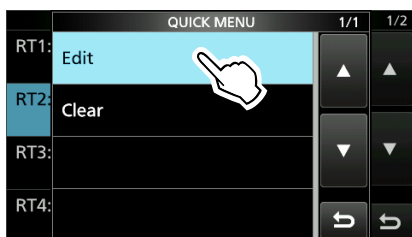

6. To clear a character, touch [←] or [→] to move the cursor, then touch [CLR].

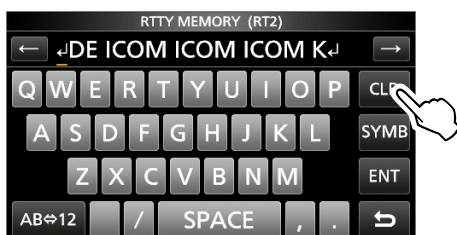

7. Enter new characters, and then touch [ENT] to save.

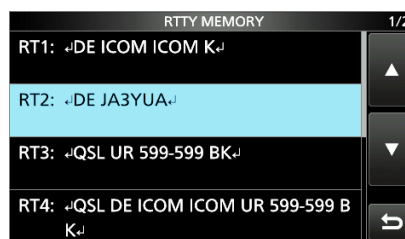

8. To close to the RTTY MEMORY screen, push **EXIT**.

2. ADVANCED OPERATIONS

Operating RTTY (FSK)

◇ Turning ON the RTTY log

Turn ON the RTTY log to save your TX and RX RTTY operating record onto a microSD card.

- ① You can select the data format type in “Log Set” on the RTTY DECODE LOG screen.
- ① The log is saved even while “HOLD” is ON.

1. Display the RTTY DECODE LOG screen.

MENU » **DECODE > <1> > LOG**

2. Touch “Decode Log.”

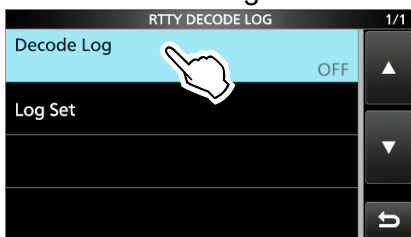

3. Touch “ON.”

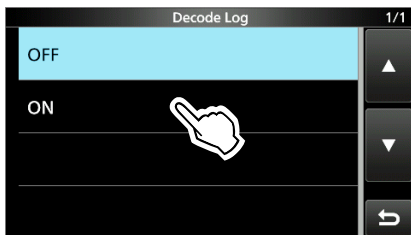

4. To close the RTTY DECODE LOG screen, push **EXIT**.
 - “●” is displayed on the RTTY DECODE screen while the RTTY log is ON.
5. To turn OFF the RTTY log, touch “OFF” in step 3.

TIP: You can set the item to its default by touching the item for 1 second, and then touching “Default” on the QUICK MENU screen.

◇ Viewing the RTTY log contents

You can view the saved RTTY log contents.

1. Insert the microSD card that the RTTY log is saved.
2. Display the RTTY DECODE LOG VIEW screen in the RTTY mode.

MENU » **DECODE > <1> > LOG VIEW**

3. Touch the log file to view.

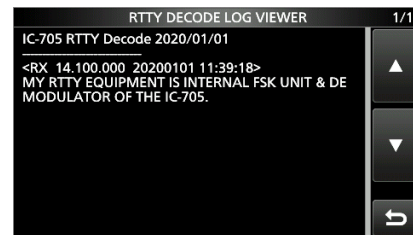
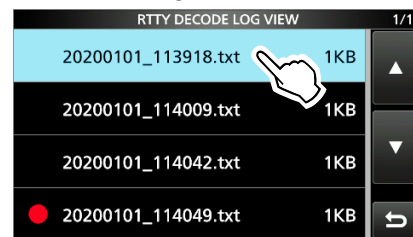

- ① The file with “●” in front of it is logging. You cannot view this log’s contents.

4. To close the RTTY DECODE LOG VIEW screen, push **EXIT** several times.

Checking the file information and deleting a file

1. Touch the log file that you want to view or delete for 1 second.
2. Touch an item from “File Information,” “Delete,” and “Delete All.”

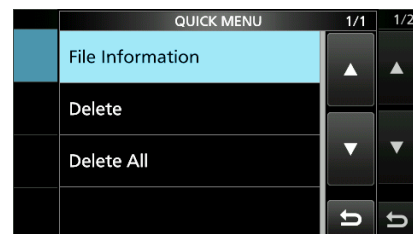

- File Information: Displays the file name, size, and logged date.
- Delete: Deletes the selected log file.
- Delete All: Deletes all log files.

2. ADVANCED OPERATIONS

Operating RTTY (FSK)

◇ RTTY DECODE LOG SET screen

In this screen, you can set the log file type, time stamp setting, and other RTTY settings.

1. Display the RTTY DECODE LOG screen.

MENU » **DECODE > <1> > LOG**

2. Touch “Log Set.”

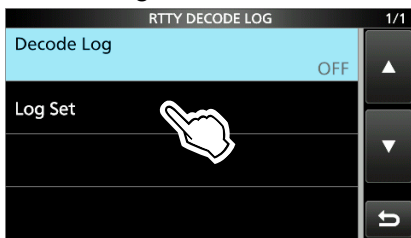

3. Touch the item to set.
(Example: File Type)

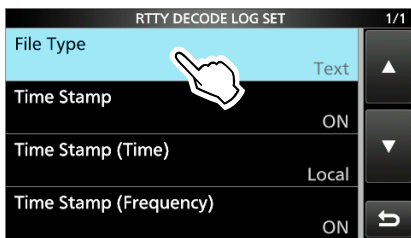

4. Touch the option to set. (Example: HTML)

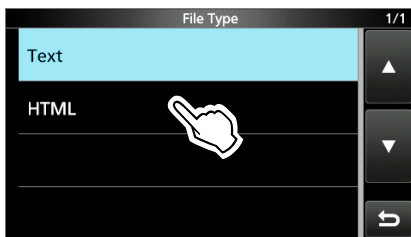

5. To close the RTTY DECODE LOG SET screen, push **EXIT** several times.

TIP: You can set the item to its default by touching the item for 1 second, and then touching “Default” on the QUICK MENU screen.

File Type (Default: Text)

Selects the file type to save a log onto a microSD card from Text and HTML.

① You cannot change the file type while logging.

Time Stamp (Default: ON)

Selects whether or not to add the time stamp (date, transmission time, and reception time) in the log.

- ON: Adds the time stamp in the log.
- OFF: Does not add the time stamp.

Time Stamp (Time) (Default: Local)

Selects whether to save the log with the local time or with the UTC time.

Time Stamp (Frequency) (Default: ON)

Selects whether or not to add the frequency in the log.

- ON: Adds the frequency.
- OFF: Does not add the frequency.

2. ADVANCED OPERATIONS

Operating RTTY (FSK)

◇ RTTY DECODE SET screen

In this screen, you can set the FFT scope setting, USOS function, and so on.

1. Display the RTTY DECODE screen.

MENU » **DECODE**

2. Touch [EXPD/SET] for 1 second.



- Opens the RTTY DECODE SET screen.

3. Touch the item to set.
(Example: FFT Scope Averaging)

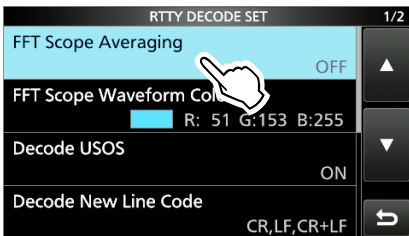

4. Touch the option to set. (Example: 2)

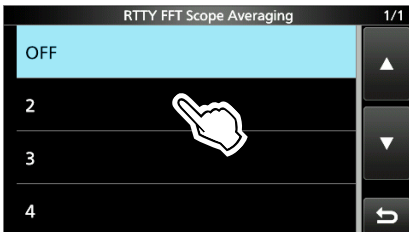

5. To close the RTTY DECODE SET screen, push **EXIT** several times.

TIP: You can set the item to its default by touching the item for 1 second, and then touching “Default” on the QUICK MENU screen.

FFT Scope Averaging (Default: OFF)

Sets the FFT scope waveform averaging function to between 2 and 4, or OFF.

- ① Use the default or smaller FFT scope waveform number for tuning.

FFT Scope Waveform Color

(Default: R: 51, G: 153, B: 255)

Sets the waveform color for the FFT scope.

- ① Touch and select the R (Red), G (Green), or B (Blue) scale, and then rotate **MULTI** to adjust the level to between 0 and 255.

- ① The color is displayed in the box above the RGB scale.

Decode USOS

(Default: ON)

Turns the letter code decoding capability ON or OFF after receiving a “space.”

- ① USOS stands for UnShift On Space function.

- ON: Decodes as a letter code.
- OFF: Decodes as a character code.

Decode New Line Code

(Default: CR, LF, CR+LF)

Selects the internal RTTY decoder new line code.

- ① CR stands for Carriage Return, and LF stands for Line Feed.

- CR,LF,CR+LF: Makes a new line with any code.
- CR+LF: Makes a new line with only a CR+LF code.

TX USOS

(Default: ON)

Explicitly inserts the FIGS character, even though it is not required by the receiving station.

- ON: Inserts FIGS.
- OFF: Does not insert FIGS.

Font Color (Receive)

(Default: R: 128, G: 255, B: 128)

Font Color (Transmit)

(Default: R: 255, G: 106, B: 106)

Sets the text font color for received or transmit characters.

- ① Touch and select the R (Red), G (Green), or B (Blue) scale, and then rotate **MULTI** to adjust the level to between 0 and 255.

- ① The color is displayed in the box above the RGB scale.

2. ADVANCED OPERATIONS

Tone squelch operation

FM mode

The Tone squelch opens only when you receive a signal that includes a matching subaudible tone in the FM mode. You can silently wait for calls from other stations using the same tone. When you transmit, the tone frequency is superimposed on your own signal.

1. Push **[FUNCTION]**.
 - Opens the FUNCTION screen.
2. Touch **[TONE]**.



3. Touch the Tone squelch type. (Example: TSQL)



4. Touch **[TONE]** for 1 second.



5. Rotate **(MAIN DIAL)** to set the tone frequency.

About the Tone squelch types indication

TSQL: Tone Squelch function

DTCS(T)/TSQL(R) (“D” in “D-TSQL” blinks):

DTCS code in TX, Tone squelch in RX

TONE(T)/TSQL(R) (“T” in “T-TSQL” blinks):

Repeater tone in TX, Tone squelch in RX

Checking another station’s tone frequency

You can check another station’s tone frequency by tone scanning while the station is transmitting.

1. Touch **[T-SCAN]**.



Blinks while scanning

- The scan starts, and then stops when the matching tone frequency from the other station is received.

2. To close the TONE FREQUENCY screen, push **[EXIT]**.

Selectable tone frequencies

67.0	88.5	114.8	151.4	177.3	203.5	250.3
69.3	91.5	118.8	156.7	179.9	206.5	254.1
71.9	94.8	123.0	159.8	183.5	210.7	
74.4	97.4	127.3	162.2	186.2	218.1	
77.0	100.0	131.8	165.5	189.9	225.7	
79.7	103.5	136.5	167.9	192.8	229.1	
82.5	107.2	141.3	171.3	196.6	233.6	
85.4	110.9	146.2	173.8	199.5	241.8	

2. ADVANCED OPERATIONS

DTCS code squelch operation

FM mode

The Tone squelch opens only when you receive a signal that includes a matching DTCS code in the FM mode. You can silently wait for calls from other stations using the same tone. When you transmit, the DTCS code is superimposed on your own signal.

1. Push **[FUNCTION]**.
 - Opens the FUNCTION screen.
2. Touch **[TONE]**.



3. Touch the DTCS code type. (Example: DTCS)

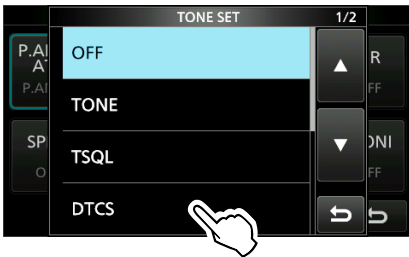

4. Touch **[TONE]** for 1 second.



5. Rotate **(MAIN DIAL)** to set a DTCS code.

About the DTCS code types indication

DTCS: DTCS Code function

DTCS(T) (“DTCS” blinks):

DTCS code in TX, Tone off in RX

TONE(T)/DTCS(R) (“T” in “T-DTCS” blinks):

Repeater tone in TX, DTCS code squelch in RX

DTCS(T)/TSQ(L(R)) (“D” in “D-TSQL” blinks):

DTCS code in TX, Tone squelch in RX

Checking another station’s DTCS code

You can check another station’s tone code by tone scanning while the station is transmitting.

1. Touch **[T-SCAN]**.

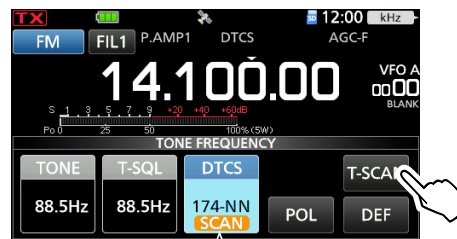

Blinks while scanning

- The scan starts, and then stops when the matching DTCS code from the other station is received.

2. To close the TONE FREQUENCY screen, push **[EXIT]**.

Selectable DTCS codes

023	054	125	165	245	274	356	445	506	627	732
025	065	131	172	246	306	364	446	516	631	734
026	071	132	174	251	311	365	452	523	632	743
031	072	134	205	252	315	371	454	526	654	754
032	073	143	212	255	325	411	455	532	662	
036	074	145	223	261	331	412	462	546	664	
043	114	152	225	263	332	413	464	565	703	
047	115	155	226	265	343	423	465	606	712	
051	116	156	243	266	346	431	466	612	723	
053	122	162	244	271	351	432	503	624	731	

2. ADVANCED OPERATIONS

Repeater operation

A repeater receives your transceiver's signals and simultaneously retransmits them on a different frequency to provide a greater communication range.

When using a repeater, the transmit frequency shifts from the receive frequency by an offset amount. You can access a repeater using the split function.

1. Select the VFO mode.
2. Set the operating mode to "FM."
3. Set the receive frequency (Repeater output frequency).

For only the USA version:

When the Auto Repeater function is turned ON, steps 4 and 5 are not necessary. The Auto Repeater function automatically sets the repeater settings (duplex ON/OFF, duplex direction, tone encoder ON/OFF).

① You can turn OFF the function and manually set the repeater settings.

MENU » **SET > Function > Auto Repeater**

4. Set the Duplex direction and frequency offset.
① See page 2-17 for setting details.
5. Turn ON the repeater tone, and set the repeater tone frequency.
① See page 2-16 for setting details.
6. Communicate in a normal way.
 - Subaudible tones are superimposed on your transmit signal.

TIP: To access a repeater using the DR function, see Section 13 for details.

◇ Checking the repeater input signal

You can check whether or not you can directly receive another station's transmit signal, by listening to the repeater input frequency.

① While listening, the TX/RX indicator lights green, and then the Noise Reduction and Notch Filter settings are canceled.

While receiving, hold down **XFC** to listen to the repeater input frequency.

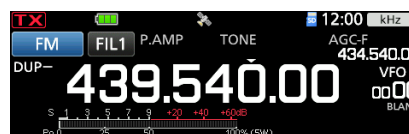

While holding down **XFC**.



2. ADVANCED OPERATIONS

Repeater operation

◇ Setting the repeater tone frequency

Most repeaters require a subaudible tone to be accessed. Subaudible tones are superimposed on your signal, and must be set in advance. Do the following steps to set the tone frequency.

1. Push **[FUNCTION]**.
 - Opens the FUNCTION screen.
2. Touch **[TONE]**.



3. Touch "TONE."



- Turns ON the repeater tone.
4. Touch **[TONE]** for 1 second.

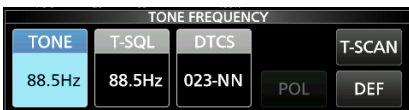

5. Rotate **(MAIN DIAL)** to set the desired subaudible tone frequency.

Selectable tone frequencies

67.0	88.5	114.8	151.4	177.3	203.5	250.3
69.3	91.5	118.8	156.7	179.9	206.5	254.1
71.9	94.8	123.0	159.8	183.5	210.7	
74.4	97.4	127.3	162.2	186.2	218.1	
77.0	100.0	131.8	165.5	189.9	225.7	
79.7	103.5	136.5	167.9	192.8	229.1	
82.5	107.2	141.3	171.3	196.6	233.6	
85.4	110.9	146.2	173.8	199.5	241.8	

Checking the repeater tone frequency

You can check the tone frequency by receiving the repeater's input frequency using the tone scan. To receive the input signals, the transceiver detects the subaudible tone frequency using the tone scan function.

1. Touch **[T-SCAN]**.



Blinks while scanning

- The scan starts, and then stops when the matching tone frequency from the repeater is received.
2. To close the TONE FREQUENCY screen, push **[EXIT]**.

◇ 1750 Hz tone burst

A 1750 Hz tone is required to access many European Repeaters.

① This operation is only for the EUR version.

1. Assign "T-CALL" to the microphone's key on the REMOTE MIC KEY screen.

[MENU] » **SET > Function > Remote MIC Key**

① When you use the optimal Bluetooth headset, you can assign "T-CALL" to the Custom key on the optional Bluetooth headset.

[MENU] » **SET > Bluetooth Set > Headset Set > Icom Headset > Custom Key**

2. Set the operating mode to "FM."
3. While holding down **[PTT]** to transmit, push the key that "T-CALL" is assigned to.
 - Accesses the repeater with a short tone burst.
 - Displays "1750Hz TONE."
4. Operate in a normal way.

2. ADVANCED OPERATIONS

Duplex operation

The Duplex operation shifts the transmit frequency up or down from the receive frequency by an offset amount.

- OFF: For simplex operation (the receive and transmit frequencies are the same).
- DUP-: The transmit frequency shifts down from the receive frequency by the offset amount.
- DUP+: The transmit frequency shifts up from the receive frequency by the offset amount.

1. Push **[FUNCTION]**.
 - Opens the FUNCTION screen.
2. Touch ② at the bottom of the screen.
3. Touch **[DUP]**.



① Touching **[DUP]** changes between “DUP-,” “DUP+,” and OFF.

4. Touch **[DUP]** for 1 second.



5. Enter the frequency offset, and then touch **[ENT]**.



NOTE: For only USA version:

When the Auto Repeater function is ON, and the operating frequency is set out of the Repeater output frequency range, the duplex mode is automatically canceled.

[MENU] » **SET > Function > Auto Repeater**

Data communication

SSB-DATA, AM-DATA, and FM-DATA modes

You can operate the data mode using AFSK (Audio Frequency Shift Keying).

① When operating PSK31, SSTV, or JT65B with a PC application software, refer to the software's instruction manual.

1. Connect a PC or other device to the transceiver.
 - ① See page 18-1 for details.
2. Set the operating frequency and mode.
3. Refer to the application software for communication details.
 - ① When operating in the SSB data mode, adjust the device's output level within the ALC zone.

TIP: The carrier point is displayed when operating AFSK in the SSB data mode. See the illustration below for a tone-pair example.

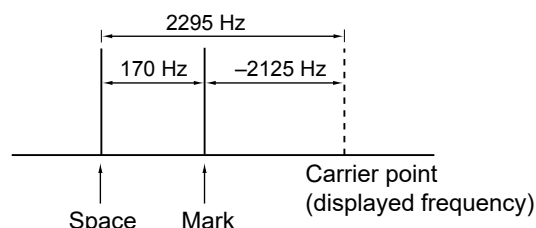

About the 5 MHz frequency band operation (USA version only)

Operation on the 5 MHz frequency band is allowed on 5 discrete frequencies, and you must adhere to the following:

- Only use the USB, USB Data, and CW modes.
- Maximum of 100 watts ERP (Effective Radiated Power)
- Maximum 2.8 kHz bandwidth

It is your responsibility to set all controls so that transmission in this frequency band meets the stringent conditions under which amateur operations may use these frequencies.

TIP: We recommend that you save these frequencies, modes, and filter settings into memory channels, for easy recall.

NOTE: To assist you in operating within the rules specified by the FCC, the transmission is illegal on any frequencies other than the five shown in the tables on the right.

For the USB and USB data modes:

The FCC specifies center frequencies on the 5 MHz frequency band. However, the transceiver displays carrier frequency. Therefore, tune the transceiver 1.5 kHz below the specified FCC channel center frequency.

Transceiver displayed frequency	FCC channel center frequency
5.33050 MHz	5.33200 MHz
5.34650 MHz	5.34800 MHz
5.35700 MHz	5.35850 MHz
5.37150 MHz	5.37300 MHz
5.40350 MHz	5.40500 MHz

For the CW mode:

The transceiver displays the center frequency. Therefore, tune the transceiver to the specified FCC channel frequency when you operate in these modes.

Transceiver displayed frequency	FCC channel center frequency
5.33200 MHz	5.33200 MHz
5.34800 MHz	5.34800 MHz
5.35850 MHz	5.35850 MHz
5.37300 MHz	5.37300 MHz
5.40500 MHz	5.40500 MHz

2. ADVANCED OPERATIONS

Weather channel operation (USA version only)

There are 10 weather channels for monitoring the National Oceanographic and Atmospheric Administration (NOAA) weather broadcasts.

◇ Selecting a Weather channel

1. Push **QUICK** to open the QUICK MENU screen.
2. Touch “Weather CH.”

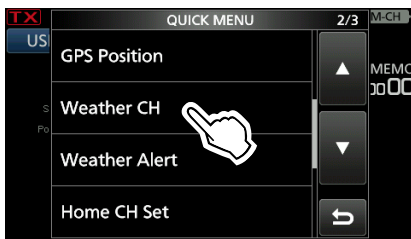

- Enters the Weather channel mode.
3. Rotate **MULTI** to select a weather channel.



- Displays the selected weather channel number (“WX-01” ~ “WX-10”).

TIP: To return to the previous frequency or Memory channel, push **QUICK**, and then touch “Weather CH OFF.”

◇ Weather alert function

NOAA broadcast stations transmit weather alert tones before important weather announcements. When the weather alert function is turned ON, the selected weather channel is monitored every 5 seconds for an announcement.

When an alert signal is detected, the “ALT” and the WX channel are alternately displayed, and a beep sounds until you change the mode or weather channel, turn OFF the Weather Alert function, or turn OFF the transceiver.

The previously selected (used) weather channel is checked periodically during standby, or while scanning.

1. Push **QUICK** to open the QUICK MENU screen.
2. Touch “Weather Alert.”

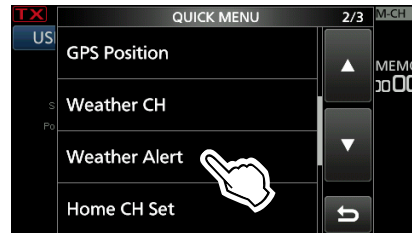

3. Touch “ON.”

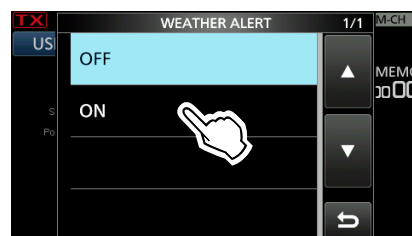

- Turns ON the Weather Alert function, and “WX” is displayed.

3. SCOPE OPERATION (ADVANCED)

Spectrum Scope screen

◇ Adjusting the sweep speed

Select the sweep speed to change the FFT scope refresh speed and the waterfall speed.

① To change only the waterfall speed, select “Slow,” “Mid,” or “Fast” in the Waterfall Speed.

1. Display the SPECTRUM SCOPE screen.

MENU » **SCOPE**

2. Touch [**< 2 >**] to display MENU 2.

3. Touch [**SPEED**] several times until the desired sweep speed is selected.

- Selectable speeds: FAST, MID, or SLOW

① “▶▶▶,” “▶▶,” or “▶” indicates FAST, MID, or SLOW.

② A popup window is displayed in the center of the SPECTRUM SCOPE screen and displays the selected sweep speed for 1 second.

“▶▶▶,” “▶▶,” or “▶” is displayed.

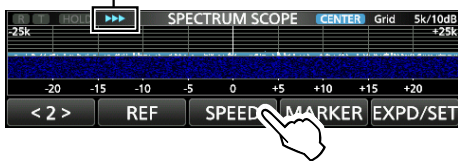

◇ Adjusting the Reference level

When monitoring a weak signal that is buried in the noise floor, or monitoring a strong signal but some stronger signals are nearby, adjusting the Reference level of the screen helps you to see these signals.

- Even if this setting is changed, it does not affect the input signal level.
 - When you adjust the Reference level, the signal strength for the waterfall also appears to change.
- ① Each band memorizes the setting.

1. Display the SPECTRUM SCOPE screen.

MENU » **SCOPE**

2. Touch [**< 2 >**] to display MENU 2.

3. Touch [**REF**].

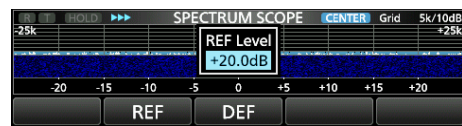
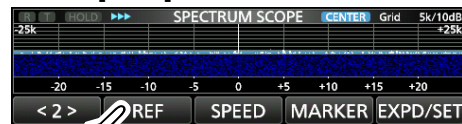

4. Rotate (**MAIN DIAL**) to adjust the level.

- Adjustable range: $-20.0 \text{ dB} \sim +20.0 \text{ dB}$

① You can reset to $\pm 0.0 \text{ dB}$ by touching [**DEF**] for 1 second.

5. To close the REF Level window, touch [**REF**].

The difference in the spectrum

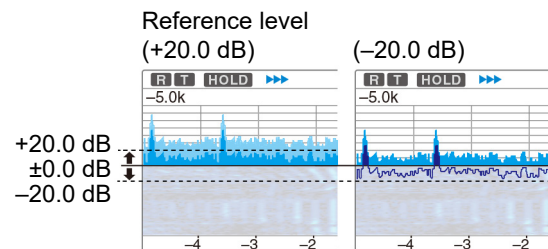

① If you adjust this setting to a positive level, all signal levels appear stronger.
Or, if you adjust to a negative level, all signal levels appear weaker.

3. SCOPE OPERATION (ADVANCED)

SCOPE SET screen

This screen is used to set the waveform color, Scope range for the Fixed mode, and so on.

1. Display the SPECTRUM SCOPE screen.

[MENU] » [SCOPE]

2. Touch [EXPD/SET] for 1 second.

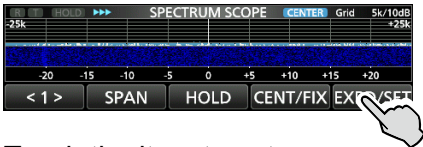

3. Touch the item to set.
(Example: Max Hold)

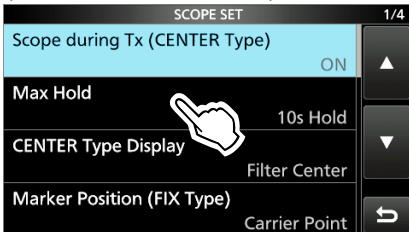

4. Touch the option to set.

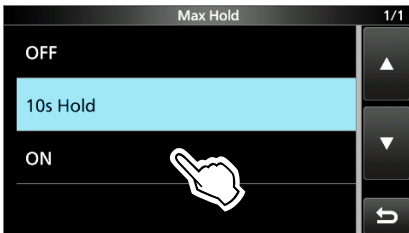

① See below for details on the setting items and their options.

5. To close the SCOPE SET screen, push [EXIT].

TIP: You can set each item to its default by touching the item for 1 second, and then touching “Default” on the QUICK MENU screen.

Scope during Tx (CENTER Type) (Default: ON)

Turns the TX signal display ON or OFF.

Max Hold (Default: 10s Hold)

Selects the peak level holding function.

- OFF: Turns OFF the peak level holding function.
- 10s Hold: Holds the peak spectrum for 10 seconds.
- ON: Continuously holds the peak spectrum.

CENTER Type Display (Default: Filter Center)

Selects the center frequency of the SPECTRUM SCOPE screen. (Only in the Center mode)

- Filter Center: Displays the selected filter’s center frequency in the center of the SPECTRUM SCOPE screen.
- Carrier Point Center: Displays the carrier point frequency of the selected operating mode in the center of the SPECTRUM SCOPE screen.
- Carrier Point Center (Abs. Freq.): In addition to the carrier point center setting above, the actual frequency is displayed at the bottom of the scope.
① Abs. Freq. : Absolute Frequency

Marker Position (FIX Type) (Default: Carrier Point)

Selects the marker position on the SPECTRUM SCOPE screen. (Only in the Fixed mode)

- Filter Center: Displays the Marker on the selected filter’s center frequency.
- Carrier Point: Displays the Marker on the carrier point frequency of the selected operating mode.

VBW (Default: Narrow)

Selects the Video Band Width (VBW).

- Narrow: Sets the VBW to narrow.
- Wide: Sets the VBW to wide.

Averaging (Default: OFF)

Sets the FFT scope waveform averaging function to between 2 and 4, or OFF.

- OFF: The FFT scope screen refreshes on each sweep. This setting displays the critical spectrum view.
- 2, 3, 4: The FFT scope screen averages 2 to 4 sweeps to smoothly display the spectrum.

3. SCOPE OPERATION (ADVANCED)

SCOPE SET screen

Waveform Type (Default: Fill)

Selects the outline waveform display for the FFT scope screen.

- Fill: Displays only the waveform, in color.
- Fill+Line: Displays both the waveform and the outline, in color.

Waveform Color (Current) (Default: (R) 172 (G) 191 (B) 191)

Sets the waveform color for the currently received signals.

- ① Touch and select the R (Red), G (Green), or B (Blue) scale, and then rotate **MULTI** to adjust the level to between 0 and 255.
- ① The color is displayed in the box above the RGB scale.

Waveform Color (Line) (Default: (R) 56 (G) 24 (B) 0)

Sets the waveform outline color for the currently received signals.

- ① Touch and select the R (Red), G (Green), or B (Blue) scale, and then rotate **MULTI** to adjust the level to between 0 and 255.
- ① The color is displayed in the box above the RGB scale.

Waveform Color (Max Hold) (Default: (R) 45 (G) 86 (B) 115)

Sets the waveform color for the received signals maximum level.

- ① Touch and select the R (Red), G (Green), or B (Blue) scale, and then rotate **MULTI** to adjust the level to between 0 and 255.
- ① The color is displayed in the box above the RGB scale.

Waterfall Display (Default: ON)

Turns the Waterfall display ON or OFF for the normal scope or Mini scope screen.

- ① On the Expanded scope screen, the Waterfall is always displayed.
- OFF: Turns OFF the Waterfall display.
- ON: Turns ON the Waterfall display.

Waterfall Speed (Default: Mid)

Selects the Waterfall speed.

- Slow: Sets the Waterfall speed to Slow.
- Mid: Sets the Waterfall speed to Mid.
- Fast: Sets the Waterfall speed to Fast.

Waterfall Size (Expand Screen) (Default: Mid)

Selects the Waterfall height in the Expand scope screen.

- Small: The same height as the Normal scope screen, only the FFT scope expands.
- Mid: The Waterfall height expands at the same ratio as the FFT scope.
- Large: Only the Waterfall height expands.

Waterfall Peak Color Level (Default: Grid 8)

Selects the signal level that the Waterfall displays a peak color.

Higher signal levels are Red, Yellow, Green, Light-blue, Blue, and Black, in that order.

- Select between Grid 1 and Grid 8.

Waterfall Marker Auto-hide (Default: ON)

Turns the Waterfall Marker Auto-hide function ON or OFF.

- OFF: The marker in the Waterfall zone stays ON.
- ON: The marker in the Waterfall zone is hidden 2 seconds after it stops in place.

3. SCOPE OPERATION (ADVANCED)

SCOPE SET screen

Fixed Edges

0.03 – 1.60 (Default: No.1 0.500–1.500 MHz)
 (Default: No.2 0.500–1.500 MHz)
 (Default: No.3 0.500–1.500 MHz)

Sets the Upper and Lower Edge frequencies in the Fixed mode. Three edges are assigned to each band.

NOTE:

- First set the lower Edge frequency.
- Set the upper Edge frequency within 1 MHz of the lower frequency.

- Settable range: 0.030 ~ 1.600 MHz



① Touch **↔** to select the upper and lower edge frequency, and then rotate **⊕MULTI** or touch the keypad to edit the frequency.

1.60 – 2.00 (Default: No.1 1.800–2.000 MHz)
 (Default: No.2 1.800–1.830 MHz)
 (Default: No.3 1.900–1.930 MHz)

- Settable range: 1.600 ~ 2.000 MHz

2.00 – 6.00 (Default: No.1 3.500–4.000 MHz)
 (Default: No.2 3.500–3.575 MHz)
 (Default: No.3 3.750–3.850 MHz)

- Settable range: 2.000 ~ 6.000 MHz

6.00 – 8.00 (Default: No.1 7.000–7.300 MHz)
 (Default: No.2 7.000–7.030 MHz)
 (Default: No.3 7.030–7.200 MHz)

- Settable range: 6.000 ~ 8.000 MHz

8.00 – 11.00 (Default: No.1 10.100–10.150 MHz)
 (Default: No.2 10.100–10.130 MHz)
 (Default: No.3 10.130–10.150 MHz)

- Settable range: 8.000 ~ 11.000 MHz

11.00 – 15.00(Default: No.1 14.000–14.350 MHz)
 (Default: No.2 14.000–14.100 MHz)
 (Default: No.3 14.100–14.350 MHz)

- Settable range: 11.000 ~ 15.000 MHz

15.00 – 20.00(Default: No.1 18.068–18.168 MHz)
 (Default: No.2 18.068–18.110 MHz)
 (Default: No.3 18.110–18.168 MHz)

- Settable range: 15.000 ~ 20.000 MHz

20.00 – 22.00(Default: No.1 21.000–21.450 MHz)
 (Default: No.2 21.000–21.150 MHz)
 (Default: No.3 21.150–21.450 MHz)

- Settable range: 20.000 ~ 22.000 MHz

22.00 – 26.00(Default: No.1 24.890–24.990 MHz)
 (Default: No.2 24.890–24.930 MHz)
 (Default: No.3 24.930–24.990 MHz)

- Settable range: 22.000 ~ 26.000 MHz

26.00 – 30.00(Default: No.1 28.000–29.000 MHz)
 (Default: No.2 28.000–28.200 MHz)
 (Default: No.3 28.200–29.000 MHz)

- Settable range: 26.000 ~ 30.000 MHz

30.00 – 45.00(Default: No.1 30.000–31.000 MHz)
 (Default: No.2 30.000–31.000 MHz)
 (Default: No.3 30.000–31.000 MHz)

- Settable range: 30.000 ~ 45.000 MHz

45.00 – 60.00(Default: No.1 50.000–51.000 MHz)
 (Default: No.2 50.000–50.100 MHz)
 (Default: No.3 50.100–50.300 MHz)

- Settable range: 45.000 ~ 60.000 MHz

60.00 – 74.80(Default: No.1 70.000–70.500 MHz)
 (Default: No.2 70.000–70.250 MHz)
 (Default: No.3 70.250–70.500 MHz)

- Settable range: 60.000 ~ 74.800 MHz

74.80 – 108.00
 (Default: No.1 87.500– 88.500 MHz)
 (Default: No.2 97.000– 98.000 MHz)
 (Default: No.3 107.000–108.000 MHz)

- Settable range: 74.800 ~ 108.000 MHz

3. SCOPE OPERATION (ADVANCED)

SCOPE SET screen

108.00 – 137.00

(Default: No.1 118.000–119.000 MHz)

(Default: No.2 126.500–127.500 MHz)

(Default: No.3 135.000–136.000 MHz)

- Settable range: 108.000 ~ 137.000 MHz

137.00 – 200.00

(Default: No.1 144.000–144.500 MHz)

(Default: No.2 146.020–147.020 MHz)

(Default: No.3 145.800–146.000 MHz)

- Settable range: 137.000 ~ 200.000 MHz

400.00 – 470.00

(Default: No.1 432.000–433.000 MHz)

(Default: No.2 445.500–446.500 MHz)

(Default: No.3 435.000–436.000 MHz)

- Settable range: 400.000 ~ 470.000 MHz

4. microSD CARD (ADVANCED)

Loading the saved data files

You can load the Memory channels and transceiver's settings from the microSD card to the transceiver.

① The transceiver has "ALL" and "Select" loading options to choose from.

TIP: Saving the current data is recommended before loading other data into the transceiver. (Basic Manual)

1. Open the LOAD SETTING screen.

MENU » **SET > SD Card > Load Setting**

2. Touch the file to load.

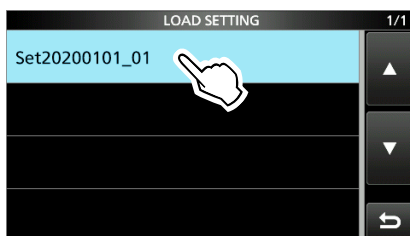

3. Touch "Select."

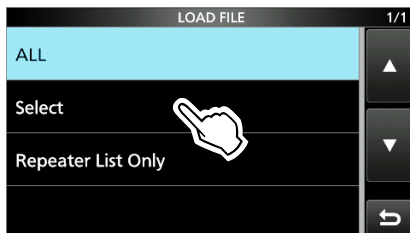

① If you want to load all the contents on the LOAD OPTION screen, touch "ALL" and go to step 6.

① If you want to load only the repeater list, touch "Repeater List Only" and go to step 6.

4. Touch the loading options. (Example: CI-V Address)

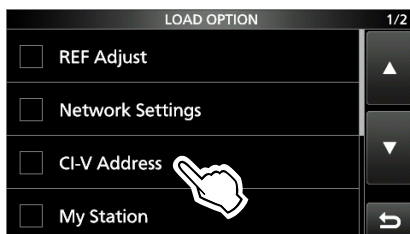

• "✓" is displayed left side of the selected option.

① The Set mode settings and Memory channel contents are always loaded.

5. Touch "<<Load>>."

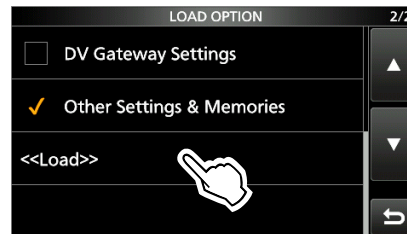

6. Touch [YES] or [NO].

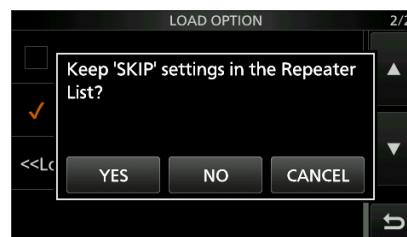

① When you touch [YES], the skip settings of the repeater list are retained.

① When you touch [NO], the skip settings of the repeater list are cleared.

7. Touch [YES].

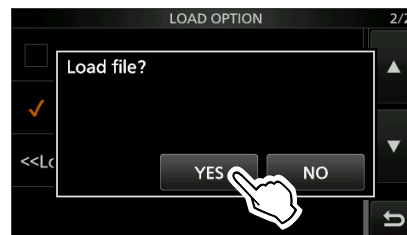

• After the loading ends, "COMPLETED! Restart the IC-705." is displayed.

① When you select "REF Adjust" in step 4, "The new "REF Adjust" setting will be saved" is displayed.

8. Turn OFF the transceiver power, then turn it ON again to restart the transceiver.

4. microSD CARD (ADVANCED)

Deleting a data file

Follow the steps below to delete the files you no longer need on the microSD card.

NOTE: Deleted data from a card cannot be recalled. Before deleting any data, back up the card data onto another device.

1. Open the SAVE SETTING screen.
MENU » **SET > SD Card > Save Setting**
2. Touch the file to delete for 1 second.

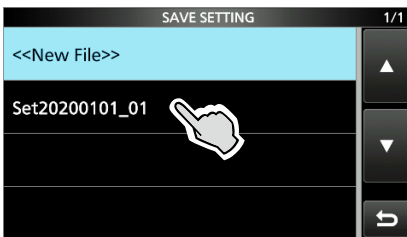

3. Touch "Delete."

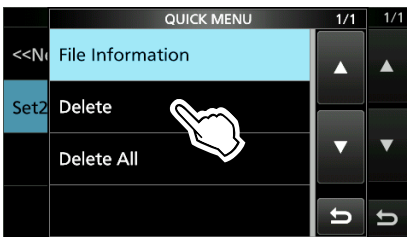

① To delete all files, touch "Delete All."
① To cancel deleting, push **EXIT**.

4. Touch [YES].

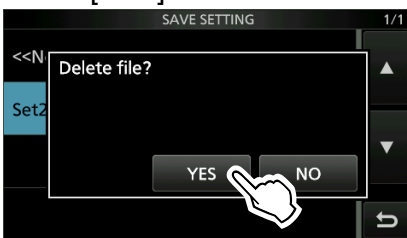

5. To close the SAVE SETTING screen, push **EXIT** several times.

TIP: Checking the file information

Touch "File Information" on the QUICK MENU screen to display the file name, size, and the saved date.

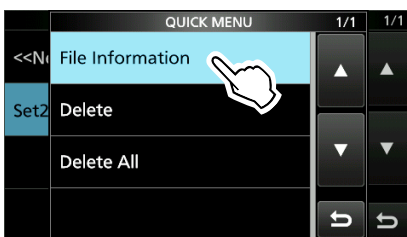

Displaying the microSD card information

You can display the microSD card capacity, and the time remaining for voice recording.

1. Open the SD CARD screen.
MENU » **SET > SD Card**
2. Touch "SD Card Info."

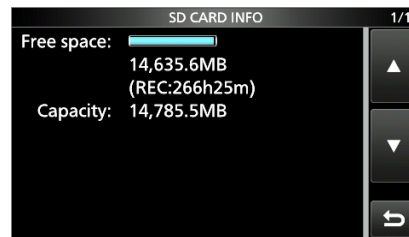
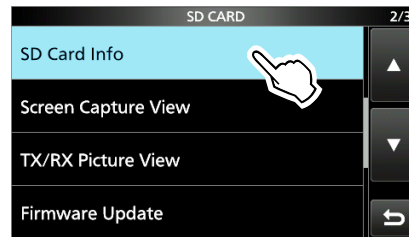

- Displays the card's free space and capacity.
3. To close the SD CARD INFO screen, push **EXIT** several times.

Importing or Exporting a CSV format file

Please read this section before importing or exporting a Comma Separated Values (CSV) format file from the microSD card.

You can import or export the following data:

- Memory CH
- Your Call Sign Memory
- Repeater List
- GPS Memory

NOTE:

- Before importing, make a backup file of all the transceiver's data to the microSD card in case of data loss.
- The transceiver cannot display a file that has a file name longer than 24 characters. In this case, rename it using 23 characters or less. When you export the data in a CSV format file using the CS-705, **BE SURE** to name it using 23 characters or less.

◇ Importing

1. Open the IMPORT/EXPORT screen.

MENU » **SET > SD Card > Import/Export**

2. Touch "Import."



3. Touch the data to import.
(Example: Your Call Sign)

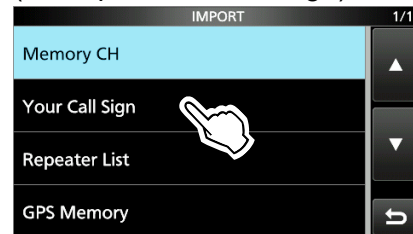

4. Touch the CSV file to import.

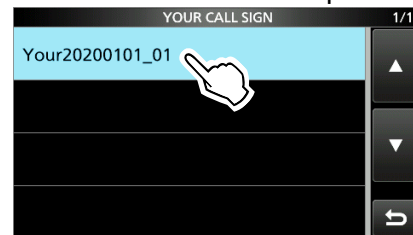

5. Touch [YES].

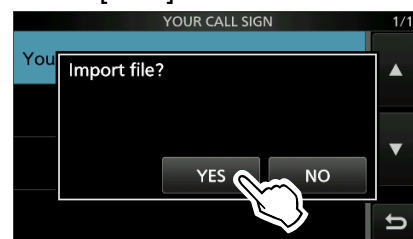

- After the importing ends, "COMPLETED! Restart the IC-705." is displayed.
6. Turn OFF the transceiver power, then turn it ON again to restart the transceiver.

TIP: To import a repeater list, see page 13-15 for details.

4. microSD CARD (ADVANCED)

Importing or Exporting a CSV format file

◇ Exporting

1. Open the IMPORT/EXPORT screen.
[MENU] » **[SET > SD Card > Import/Export]**

2. Touch “Export.”

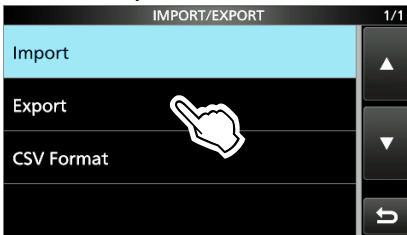

3. Touch the data to export.
(Example: Your Call Sign)

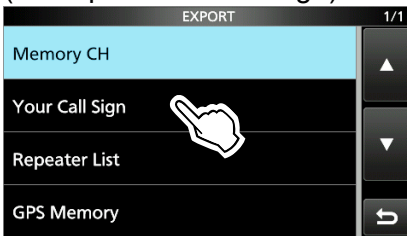

4. Touch “<<New File>>.”



- ① The file name is automatically set in the following format: Your*yyyymmdd_xx (yyyy: Year, mm: month, dd: day, xx: serial number).
 - * “Mch” is displayed for a Memory channel contents.
 - “Rpt” is displayed for a repeater list.
 - “Gps” is displayed for a GPS memory.

5. To save the file with the displayed name, touch **[ENT]**.

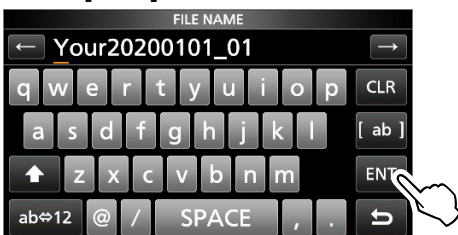

- ① If you want to change the name, delete the name and reenter it, and then touch **[ENT]**.

6. Touch **[YES]**.

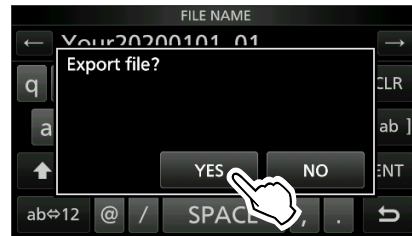

7. To close the EXPORT screen, push **[EXIT]** several times.

4. microSD CARD (ADVANCED)

About the microSD card's folders

The folder in the microSD card contains the following.

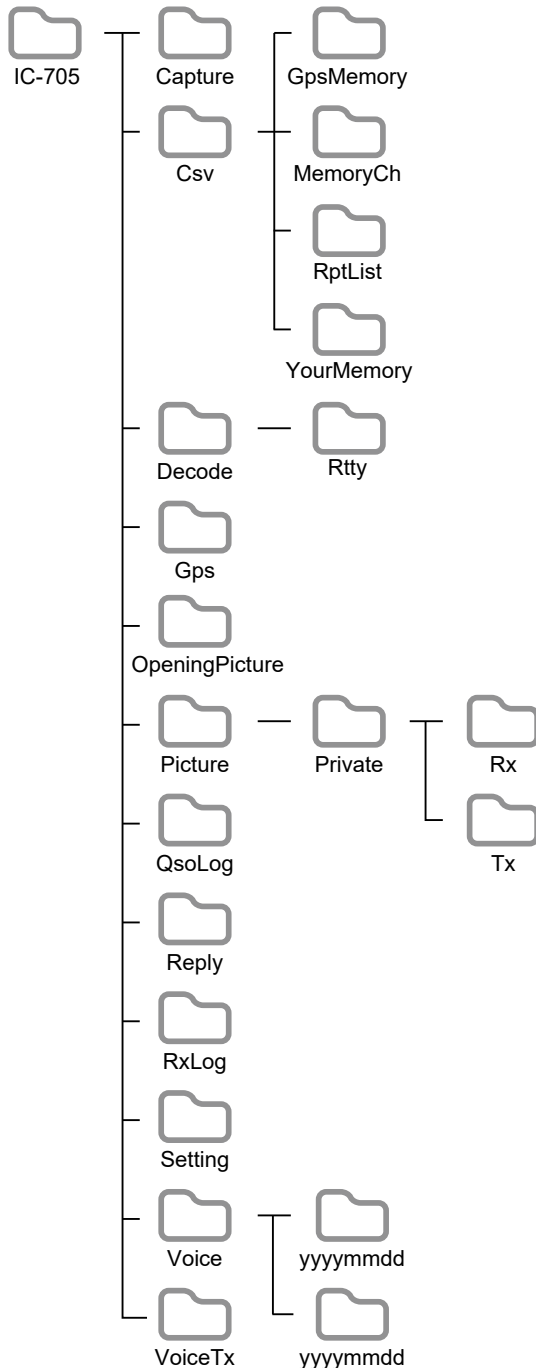

- **IC-705 folder**
The folders created in the IC-705 are contained in this folder.
- **Capture folder**
The captured screen data in the “png” or “bmp” format.
- **Csv folder**
The GPS Memory, Memory channel, Repeater List, and Your (UR) call sign memory folders.

- **GpsMemory folder**
The GPS Memory in the “csv” format.
- **MemoryCh folder**
The Memory channel contents in the “csv” format.
- **RptList folder**
The Repeater List in the “csv” format.
- **YourMemory folder**
Your (UR) call sign memory in the “csv” format.
- **Decode folder**
The RTTY decode log folder.
- **RTTY folder**
The transmitted or received RTTY decode log data in the “txt” or “html” format.
- **GPS folder**
The GPS logging file in the “log” format.
- **OpeningPicture folder**
The pictures in the “bmp” format that are used for the Opening Picture setting.
- **Picture folder**
The pictures in the “jpg” format that are used with the Share Pictures function.
- **Private folder**
The RX Picture History and TX Picture History.
- **Rx folder**
The RX Picture History in the “dat” format.
①The RX Picture History contents are not displayed on the PC.
- **Tx folder**
The TX Picture History in the “dat” format.
①The TX Picture History contents are not displayed on the PC.
- **QSOLog**
The QSO log data in the “csv” format.
- **Reply folder**
The Automatic reply data in the “wav” format.
- **RxLog folder**
The RX record log data in the “csv” format.
- **Setting folder**
The transceiver’s setting data in the “icf” format.
- **Voice folder**
The recorded QSO audio date folders.
- **yyyyymmdd folder**
The recorded audio file in the “wav” format.
The folder name is automatically created in the following format:
yyyyymmdd (yyyy: year, mm: month, dd: day)
- **VoiceTx folder**
The recorded voice audio data for the Voice TX function in the “wav” format.

5. VOICE RECORDER FUNCTIONS

Recording a QSO audio

This transceiver is equipped with a QSO recorder not only for the receive audio but also for the transmit audio.

This function is useful to make a QSO record, or to confirm your QSO with a rare entity's station, or on a DX'pedition. You can also use the function to repeatedly transmit the same voice message.

The recorded contents are saved onto a microSD card.

There are 2 ways to start recording.

- Push **QUICK** and touch "<<REC Start>>."
 - Push **MENU** and touch [RECORD].
- ① The recorded audio is saved in the "Voice" folder on the microSD card.
- ② When "PTT Auto REC" is set to ON, the recording automatically starts when you start transmitting.

MENU » **RECORD** > Recorder Set > **PTT Auto REC**

TIP: About the icons

- While recording, "●" is displayed and the microSD card icon next to the clock blinks blue.

"●" is displayed. → The SD card icon blinks.

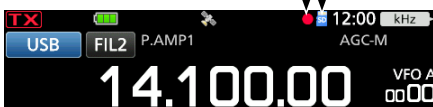

- While pausing, "||" is displayed.

"||" is displayed. →

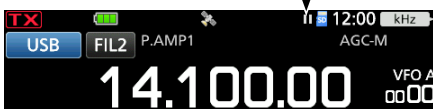

NOTE:

- To record a QSO, a microSD card (user supplied) is required.
- Do not remove the microSD card from the transceiver while recording. Otherwise, the recording stops, and the card data may be corrupted or deleted.
- Once the recording starts, it pauses and resumes if the transceiver is turned OFF and ON again.
- The recording continues until you touch <<REC Stop>>, or the free space on the microSD card has run out.
- When the recording file's content becomes 2 GB, the transceiver continues to record, but to a new file.

◇ Quick recording

You can quickly record the received audio.

1. Push **QUICK**.
 - Opens the QUICK MENU screen.
2. Touch "<<REC Start>>."

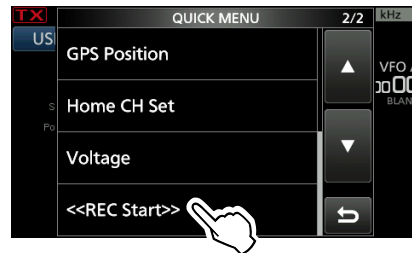

- Starts recording.
 - "Recording started." is briefly displayed.
- ① To stop recording, open the QUICK MENU screen again and touch "<<REC Stop>>."

◇ Basic recording

You can record both receive and transmit audio.

1. Open the QSO RECORDER screen.
MENU » **RECORD**
2. Touch "<<REC Start>>."

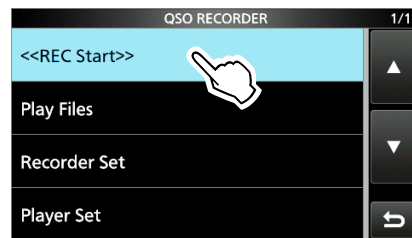

- Starts recording.
 - "Recording started." is briefly displayed.
- ① To stop recording, touch "<<REC Stop>>."
3. To close the QSO RECORDER screen, push **EXIT**.

5. VOICE RECORDER FUNCTIONS

Playing back a QSO audio

You can playback the recorded QSO audio.

1. Insert the microSD card in which the recorded audio is saved.
2. Open the PLAY FILES screen.
MENU » **RECORD > Play Files**

3. Touch the folder where the file you want to playback is saved.

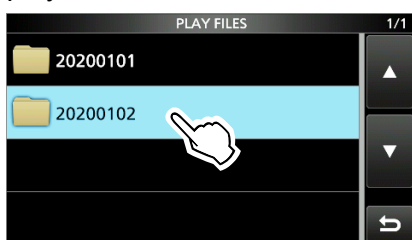

① The folder is named in the following format:
 yyyyymmdd (yyyy: Year, mm: month, dd: day).

4. Touch the desired file.

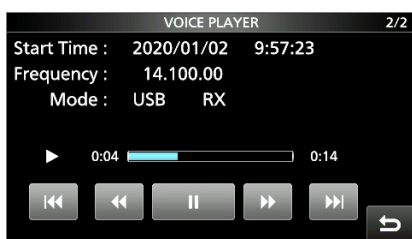
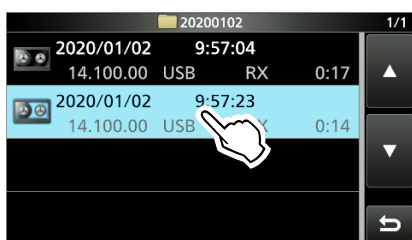

- Starts a playback.

① The file is named in the following format:
 yyyy/mm/dd hh:mm:ss (yyyy: Year, mm: month, dd: day, hh: hour, mm: minute, ss: second).

① Playback continues to the next file and stops when the last file in the folder is played back.

5. To close the PLAY FILES screen, push **EXIT** several times.

Key	Action
	Plays the previous file. ① While the oldest file is playing back, pushing starts playing the beginning of the oldest file, even if there are other files in the folder, .
	Plays the next file. ① While the most recent file is playing back, pushing stops the playback, even if there are other files in the folder.
	Rewinds to the skip time point. (Default: 10 seconds) ① If you touch within the first 1 second of the file, the end of the previously recorded file will play back.
	Fast forwards to the skip time point. (Default: 10 seconds)
	Pauses while playing ① is displayed while pausing.
	Plays the file. ① is displayed while playing.

① You can change the skip time in the following item.

MENU » **RECORD > Player Set > Skip Time**

Operating frequency and operating mode

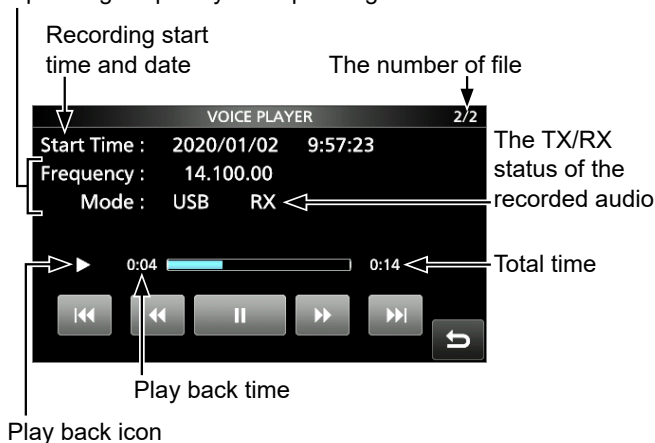

Checking the folder or file information

You can check the folder information and recorded file information, that are listed below.

Folder information

- Number of the saved files
- Total size
- Created date

RX audio file information

- Operating frequency
- Operating mode
- Operating information (RX)
- Recorded date and time
- Your position data*
- Repeater call sign*
- Caller's call sign*
- S-meter
- Caller's Position data*

TX audio file information

- Operating frequency
- Operating mode
- Operating information (TX)
- RF Power
- Recorded date and time
- Your position data*
- Repeater call sign*
- Call sign of the called station*

* Depending on the recording status, this item is not displayed.

Checking the folder information

1. Open the PLAY FILES screen.
MENU » RECORD > Play Files

2. Touch a folder for 1 second.

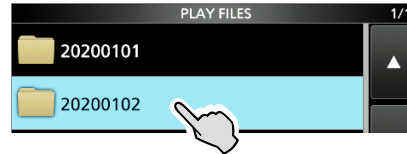

- Opens the QUICK MENU screen.

3. Touch "Folder Information."

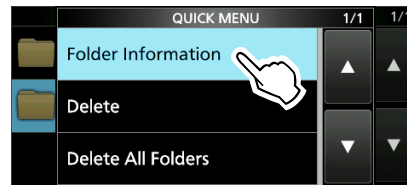

- The FOLDER INFORMATION screen is displayed.

4. To close the PLAY FILES screen, push EXIT several times.

Checking the file information

1. Open the PLAY FILES screen.
MENU » RECORD > Play Files

2. Touch a folder.

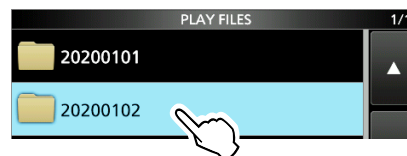

3. Touch a file to check its information for 1 second.

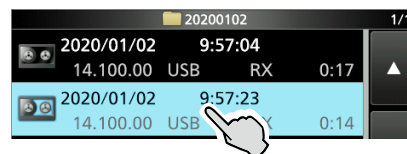

- Opens the QUICK MENU screen.

4. Touch "File Information."

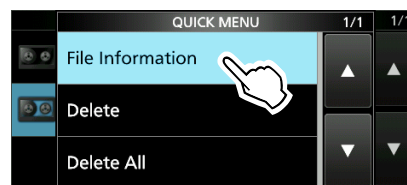

- The FILE INFORMATION screen is displayed.

5. To close the PLAY FILES screen, push EXIT several times.

5. VOICE RECORDER FUNCTIONS

Deleting files

1. Open the PLAY FILES screen.
MENU » **RECORD > Play Files**
2. Touch the folder where the file you want to delete is saved.

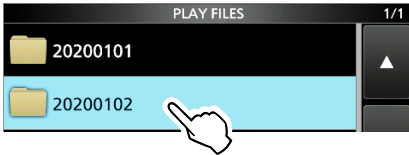

3. Touch the file that you want to delete for 1 second.



- Opens the QUICK MENU screen.

4. Touch "Delete."

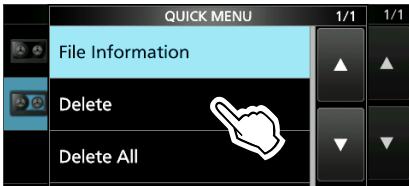

- ① If you want to delete all files in the selected folder, touch "Delete All."

5. Touch [YES].

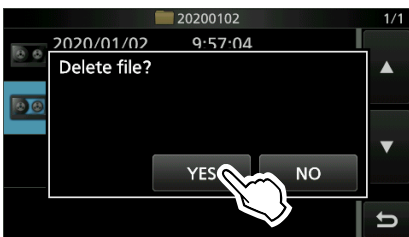

- The file is deleted and returns to the previous screen.

6. To close the PLAY FILES screen, push **EXIT** several times.

Deleting folders

NOTE: All the files in the folder are also deleted.

1. Open the PLAY FILES screen.
MENU » **RECORD > Play Files**
2. Touch the folder you want to delete for 1 second.

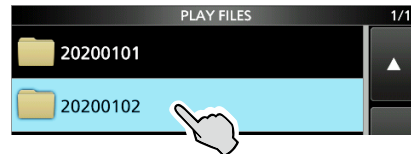

3. Touch "Delete."

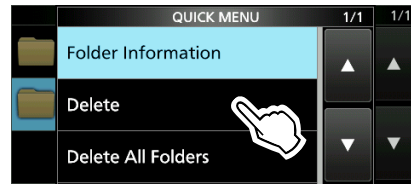

- ① If you want to delete all folders, touch "Delete All Folders."

4. Touch [YES].

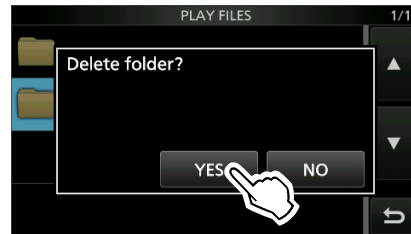

- The folder is deleted and returns to the previous screen.

5. To close the PLAY FILES screen, push **EXIT** several times.

5. VOICE RECORDER FUNCTIONS

RECORDER SET screen

You can change the recorder settings on this screen.

1. Display the RECORDER SET screen.

MENU » **RECORD > Recorder Set**

2. Touch the item to set.
(Example: TX REC Audio)

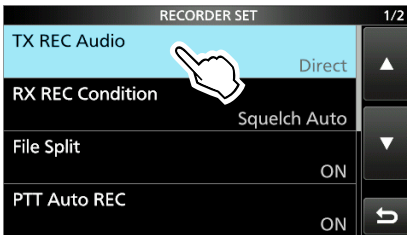

3. Touch the option to set. (Example: Monitor)

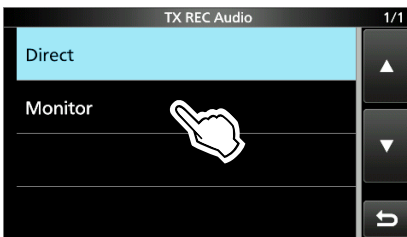

4. To close the RECORDER SET screen, push **EXIT**.

TIP: You can set each item to its default by touching the item for 1 second, and then touching "Default" on the QUICK MENU screen.

TX REC Audio (Default: Direct)

Selects the transmit audio to record.

- Direct: Records the microphone audio.
- Monitor: Records the TX monitor audio.

RX REC Condition (Default: Squelch Auto)

Selects the recording setting for receive.

- Always: Records even if no signal is received.
- Squelch Auto: Records only when the squelch opens.
(The recording will be paused when the squelch closes while recording.)

File Split (Default: ON)

Turns the File Split function ON or OFF.

- OFF: The audio is continuously recorded into the file, even if you switch between transmit and receive, or the squelch status changes between open and closed.
When the recording file's size becomes 2 GB, the transceiver continues to record, but to a new file.
- ON: While recording, if you switch between transmit and receive, or the squelch status changes between open and closed, a new file is automatically created in the same folder, and the audio is saved into the new one.

PTT Auto REC (Default: ON)

Turns the PTT Automatic Recording function ON or OFF.

- OFF: The recording does not start, even when a signal is transmitted.
- ON: The recording automatically starts when a signal is transmitted.

The recording will stop when:

- 10 seconds has passed after the last transmission.
- 10 seconds has passed if no signal is received after the last transmission.
 - If you receive a signal within 10 seconds after the last transmission, the received audio is also recorded.
 - If you receive another signal within 10 seconds after the last reception, the received audio is also recorded.
- 10 minutes has past while operating with the squelch is open in the SSB, CW, RTTY, or AM mode.
- The frequency or operating mode is changed.

PRE-REC for PTT Auto REC (Default: 10sec)

Selects whether or not to record the audio that is received before the PTT Automatic Recording function is activated.

- OFF: Does not record the audio.
- 5sec/10sec/15sec:
Records the audio that is previously received in this set period of time.

5. VOICE RECORDER FUNCTIONS

PLAYER SET screen

You can fast forward or rewind while playing back. You can change the skip time in the PLAYER SET screen.

1. Display the PLAYER SET screen.

MENU » **RECORD > Player Set**

2. Touch "Skip Time."

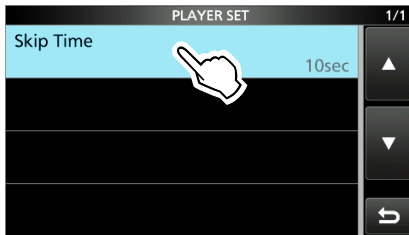

3. Touch the option to set. (Example: 5sec)

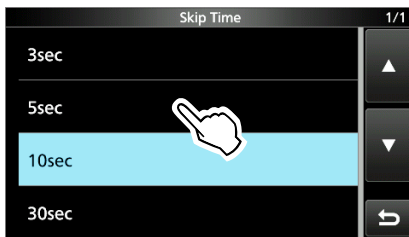

4. To close the PLAYER SET screen, push **EXIT**.

TIP: You can the item to its default by touching the item for 1 second, and then touching "Default" on the QUICK MENU screen.

Playing back audio on a PC

You can also playback the voice memory data on a PC.

① The recorded information (frequency, date, and so on) is not displayed.

1. Insert the microSD card into the memory card slot or memory card reader (user supplied) on your PC.

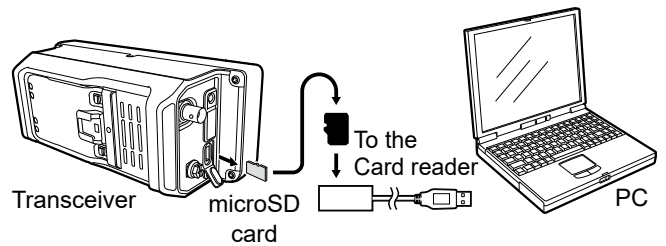

2. Open the "Voice" folder.
① See page 4-5 for detail.
3. Open the folder where the file you want to playback is saved.
① The folders are titled based on the recorded date. (yyyymmdd)
4. Open the file that you want to play back.
 - The audio starts playing back.
 - ① The files are titled based on the date and time (yyyymmdd_hhmmss.wav).

NOTE:

- The operations while playing back may differ, depending on the application. Refer to the application's instruction manual for details.
- When the file does not playback, even if you double click the file, download an appropriate software. (Example: Windows Media® Player)

6. VOICE TX MEMORY FUNCTION

Recording a Voice TX memory

SSB, AM, FM, and DV modes

You can record up to 8 Voice transmit memories (T1 ~ T8) of up to one and a half minutes in each memory, onto a microSD card. To transmit a recorded content using a Voice TX memory, first record the message, as described below.

- ① You can record up to 1 and a half minutes in each memory.
- ① You can also transmit the recorded content using an external keypad.

NOTE: To use the Voice TX memory function, a microSD card (user supplied) is required.

◆ Recording

1. Display the VOICE TX screen.

[MENU] » [VOICE]

2. Touch [REC/SET].

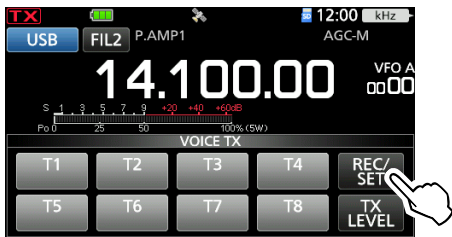

3. Touch "REC."



- Opens the VOICE TX RECORD screen.

4. Touch the desired Voice memory "T1" ~ "T8." (Example: T1)

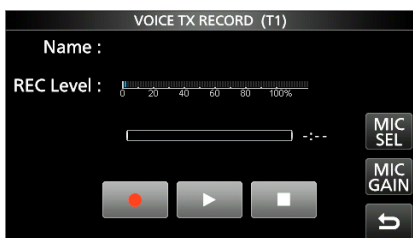
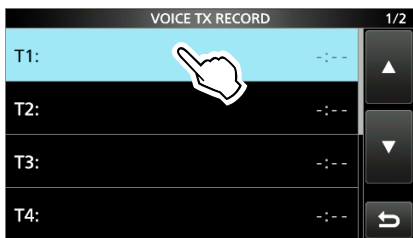

5. Touch [RECORD] to start recording.

Adjust the Mic gain so that the "REC Level" meter reads less than 80%.

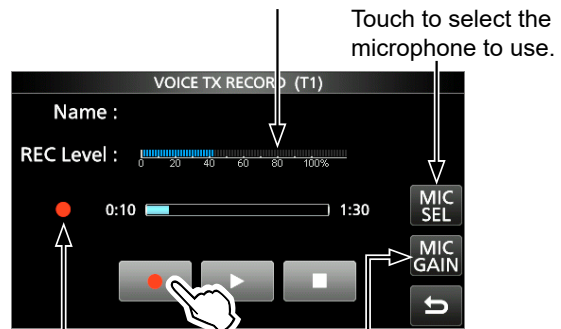

Displayed while recording Touch to open the MIC GAIN adjustment window.

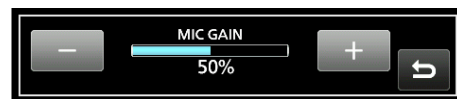

- Without holding down [PTT], speak into the microphone at your normal voice level.
- ① Previously recorded content is overwritten.
- ① When you select "Bluetooth MIC" without connecting a Bluetooth headset, "Bluetooth MIC" is displayed.

6. Touch [STOP] to stop recording.
7. To close the VOICE TX RECORD screen, push [EXIT] several times.

TIP: How to clear the recorded content
Touch the Voice memory for 1 second in step 4, and then touch "Clear" in the QUICK MENU screen.

6. VOICE TX MEMORY FUNCTION

Recording a Voice TX memory

◇ Playing back

1. On the selected memory's recording screen, touch  to start playing back without transmitting.

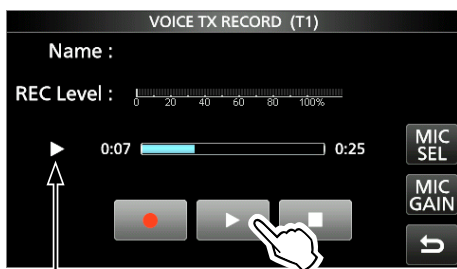

Displayed while playing

- ① To stop the playback, touch .
2. To close the VOICE TX RECORD screen, push **[EXIT]** several times.

Entering a Voice TX memory name

You can assign a name to recorded Voice memories.

Example: Entering "Contest" in Memory T1

1. Display the VOICE TX RECORD screen.
[MENU] » **VOICE > REC/SET > REC**
2. Touch the desired memory for 1 second.

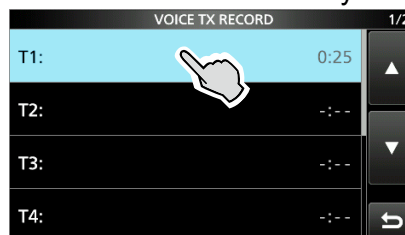

3. Touch "Edit Name."



• Opens the Name editing screen.

4. Enter a name of up to 16 characters, and then touch **[ENT]** to save.

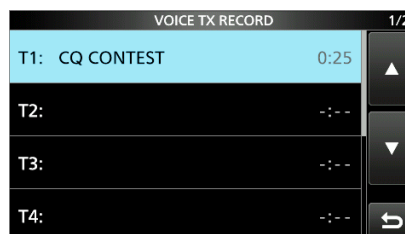
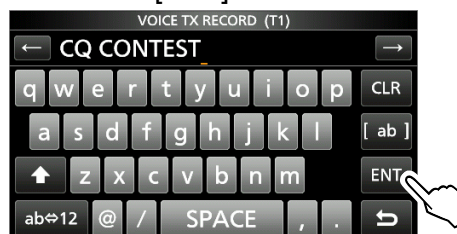

① See "Keyboard entering and editing" in the Basic Manual for details.

5. To close the VOICE TX RECORD screen, push **[EXIT]**.

6. VOICE TX MEMORY FUNCTION

Transmitting a Voice memory content

You can transmit the Voice TX memory contents once, or repeatedly. This is useful for transmitting your call sign, contest number or name in some contests, or repeatedly calling CQ.

◇ Transmitting

Transmits the prerecorded content. (p. 6-1)

1. Display the VOICE TX screen.
[MENU] » **[VOICE]**
2. Touch the desired Voice memory key [T1] ~ [T8].



The transmission's remaining time

- Transmits the recorded content once.
3. To close the VOICE TX screen, push **[EXIT]**.

When an external keypad is connected:

You can transmit the preset contents in the Voice TX memory (T1 ~ T8) from an external device by setting the "External Keypad," and then connecting an external keypad to [KEY] on the IC-705.

[MENU] » **[SET > Connectors > External Keypad]**

◇ Repeatedly transmitting

1. Display the VOICE TX screen.
[MENU] » **[VOICE]**
2. Touch the desired Voice memory key [T1] ~ [T8] for 1 second.

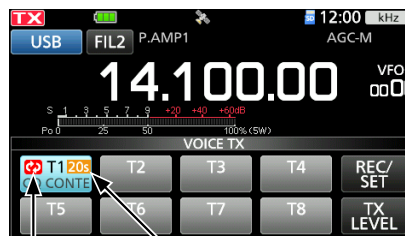
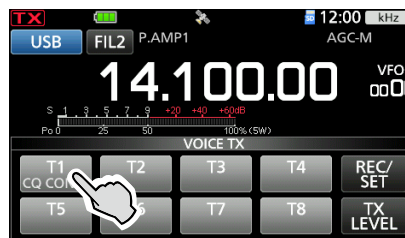

Repeat icon The transmission's remaining time

- Repeatedly transmits the recorded content.

① Information

- The recorded content is repeatedly transmitted for 10 minutes unless you manually stop transmission by touching the selected memory.
- The Memory Timer counts down.
-  is displayed while repeatedly transmitting.
- You can set the pause interval between the repeated transmissions in "Repeat Time" on the VOICE TX SET screen. During this interval, the transceiver returns to receive. (p. 6-4).
- After 10 minutes have passed, and all of the recorded content in the memory is transmitted, the transceiver automatically returns to receive.
- When a signal is received in the interval between transmissions, the transceiver pauses the next transmission until the signal disappears. However, if the squelch is set to open, the transceiver repeatedly transmits after the repeat interval time expires, even signals are received.

3. To close the VOICE TX screen, push **[EXIT]**.

TIP:

If the "DATA OFF MOD" is set to "USB" or "WLAN," Voice TX memories can not be transmitted.

[MENU] » **[SET > Connectors > MOD Input > DATA OFF MOD]**

6. VOICE TX MEMORY FUNCTION

Transmitting a Voice memory content

◇ Adjusting the output level

Adjust the Voice TX memory level.

1. Display the VOICE TX screen.

MENU » **VOICE**

2. Touch [TX LEVEL].



3. Touch any Voice memory key other than [T4] or [T8]. ([T1] ~ [T3], [T5] ~ [T7])

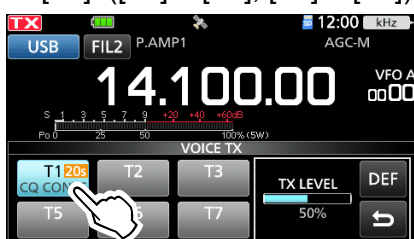

- The transceiver automatically transmits.

① To adjust the Transmit voice level using [T4] or [T8], reverse steps 2 and 3.

4. While transmitting, rotate **MAIN DIAL** to adjust the transmit voice level.

① Pushing [DEF] for 1 second returns the value to the default.

① Adjusting TX LEVEL too high may result in over modulation and transmit signal distortion.

5. To save and close the VOICE TX screen, push **EXIT** several times.

VOICE TX SET screen

You can set the Automatic Monitor function and the Transmit Repeat Interval on this screen.

1. Display the VOICE TX SET screen.

MENU » **VOICE > REC/SET > SET**

2. Touch the item to set.
(Example: Auto Monitor)

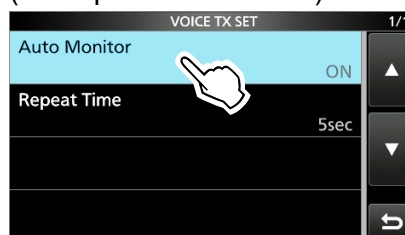

3. Touch the option to set. (Example: OFF)

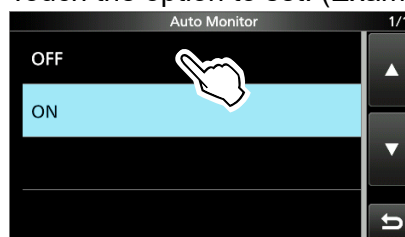

4. To close the VOICE TX SET screen, push **EXIT**.

TIP: You can set each item to its default by touching the item for 1 second, and then touching "Default" on the QUICK MENU screen.

Auto Monitor (Default: ON)

Turns the Automatic Monitor function for recorded audio contents transmission, ON or OFF.

- ON: Automatically monitors transmit audio when sending recorded audio.
- OFF: Monitors transmit audio only when the Monitor function is ON.

Repeat Time (Default: 5sec)

Sets the repeat interval to repeat the voice transmission. The transceiver repeatedly transmits the recorded content at this interval.

- Set to between 1 and 15 seconds.

① Repeatedly transmits the recorded content for up to 10 minutes.

① After 10 minutes have passed, and all of the recorded content in the memory is transmitted, the transceiver automatically returns to receive.

7. MEMORY OPERATION

Memory channels

The Memory mode enables you to quickly select often-used frequencies, modes, and other parameters. While operating in the Memory mode, you can temporarily change the operating frequency, mode, and so on, without overwriting the memory channel contents.

① To save the changed value, overwrite the memory channel contents, or copy to another Memory channel (p. 7-3).

Group	Memory channel	Displayed
00 to 99	00 to 99	Regular memory channels with split frequency capability. 1 frequency, 1 mode, 1 filter, memory name, tone settings (including tone frequencies for repeater and tone squelch), and select memory scan setting in each memory channel. ① Up to 500 channels can be separately stored in the 100 memory channel groups.
CALL CH	144 C1/C2 430 C1/C2	Call channels with split frequency capability each of the 144 and 430 bands. ① They cannot be left blank.

Selecting a memory group

1. Touch the VFO/MEMORY icon.

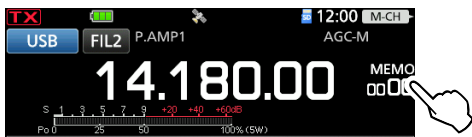

2. Touch [GROUP].



3. Touch a memory group (00 ~ 99, or CALL CH). Indicates the listed group.

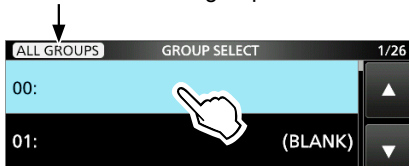

- ① You can toggle the listed group by touching the icon in the upper left corner of the screen.
- "ALL GROUPS" is displayed when all groups are listed.
 - "ACTIVATE GROUPS" is displayed when only the groups that have one or more channels are listed.

Entering Memory channel contents

NOTE: New content you enter will overwrite any content already in the selected memory.

1. Select the VFO mode. (Basic Manual)
2. Set the frequency, operating mode, and other parameters.
3. Touch the VFO/MEMORY icon.
4. Touch [MW].

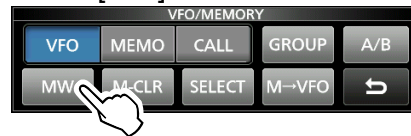

5. Touch "Write to a New Channel."

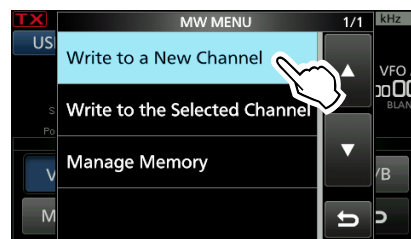

6. Touch the desired Memory channel. (Example: 00)

① To change a memory group, touch [GROUP].

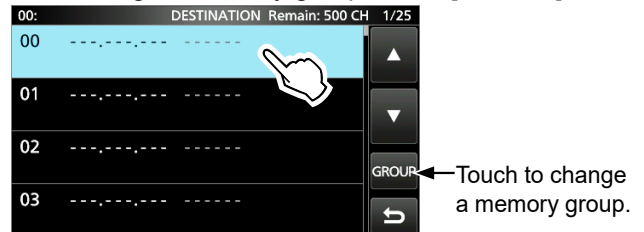

7. Touch [YES].

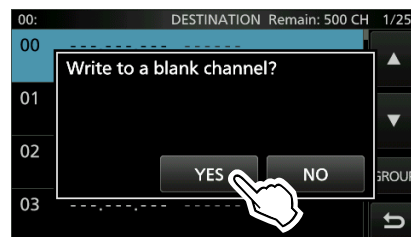

- The contents are entered in the selected Memory channel.

TIP: Touching [MW] for 1 second in step 4 enters the contents to a blank channel in the selected group.



7. MEMORY OPERATION

Selecting a Memory channel

There are 3 ways to select a Memory channel.

- Selecting with **MULTI**
- Selecting on the MEMORY screen
- Selecting using the keypad (Basic Manual).

◇ Selecting with **MULTI**

1. Select the Memory mode. (Basic Manual)
2. Assign the Select Memory Channel function to **MULTI**. (Basic Manual)
3. Rotate **MULTI** until you select the Memory channel you want to use.

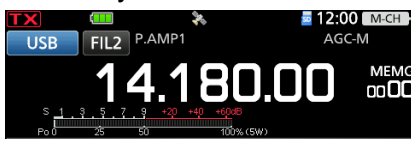

Memory mode
(Example: channel 00 in group 00)

◇ Selecting on the MEMORY screen

1. Select the Memory mode. (Basic Manual)
2. Open the MEMORY GROUP screen.

MENU » **MEMORY**

3. Touch a memory group. (Example: 00)

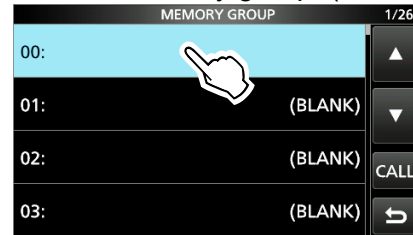

4. Touch the Memory channel that you want to use.

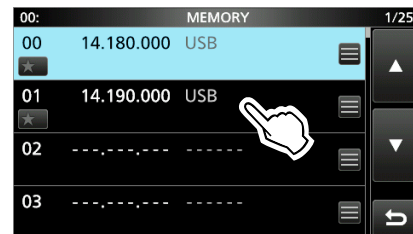

TIP: To sequentially select a channel in a different group

1. Push **QUICK**.
2. Touch "Channel Select Group Range."

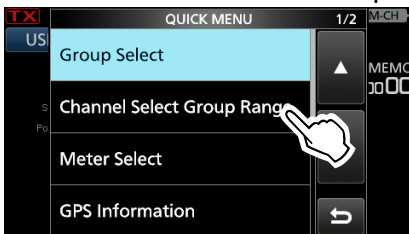

3. Touch "All Group."

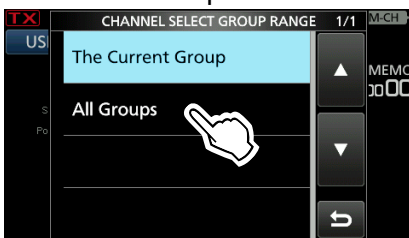

Selecting a Call channel

1. Select the 144 or 430 band.
2. Push **CALL** to select the Call Channel mode.
3. Rotate **MULTI** to select the Call channel that you want to use.

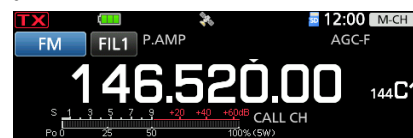

Call channel mode

7. MEMORY OPERATION

Copying the Memory channel contents

You can copy a Memory channel contents to the VFO or to another Memory channel.

◇ Copying to the VFO

1. Select the Memory mode. (Basic Manual)
2. Assign the Select Memory Channel function to **[MULTI]**. (Basic Manual)
3. Rotate **[MULTI]** to select the channel to be copied. (Example: channel 01 in group 00)
4. Touch the VFO/MEMORY icon.
5. Touch **[M→VFO]** for 1 second.



- A beep sounds, and the selected memory contents are copied to the VFO.

6. Touch **[VFO]** to select the VFO mode.



◇ Copying to another Memory channel

1. Select the Memory mode. (Basic Manual)
2. Assign the Select Memory Channel function to **[MULTI]**. (Basic Manual)
3. Rotate **[MULTI]** to select the channel to be copied. (Example: channel 00 in group 00)
4. Open the MEMORY GROUP screen.

[MENU] » **[MEMORY]**

5. Touch a memory group. (Example: 00)

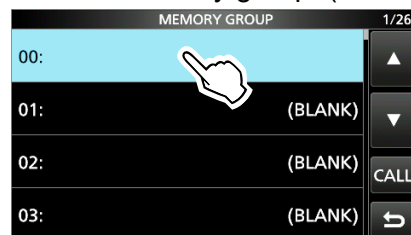

6. Touch **[≡]** of the channel that you want to write the copied contents to. (Example: channel 04)
 - ① **DO NOT** rotate **[MULTI]**. Select the channel by rotating **[MAIN DIAL]**.



7. Touch "Memory Write."

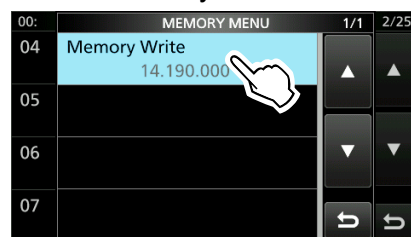

8. Touch **[Yes]**.

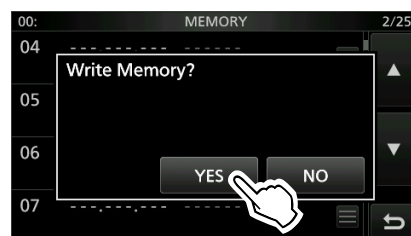

- A beep sounds, and the selected memory contents are copied.

9. To close the MEMORY screen, push **[EXIT]**.

7. MEMORY OPERATION

Entering a group/Memory name

You can assign a name of up to 16 characters to each channel group (00 ~ 99) and Memory channel.

◇ Entering a group name

1. Open the MEMORY GROUP screen.
MENU » **MEMORY**
2. Touch the channel group that you want to enter a name, for 1 second. (Example: 01)

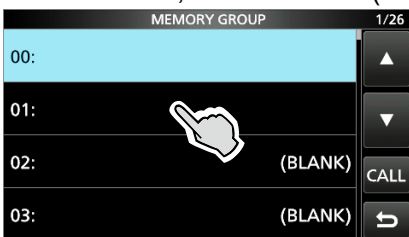

3. Touch “Edit Name.”

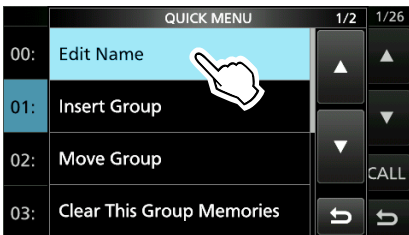

4. Enter a group name, then touch [ENT].

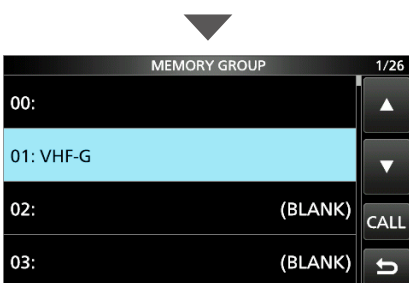
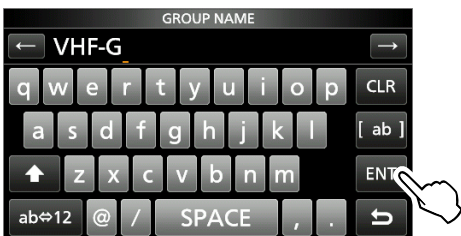

5. To close the MEMORY GROUP screen, push **EXIT**.

◇ Entering a Memory name

1. Open the MEMORY GROUP screen.
MENU » **MEMORY**
2. Touch the channel group. (Example: 01)

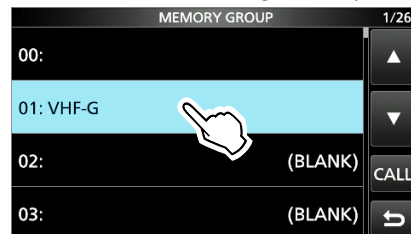

3. Touch  of the channel that you want to enter a name. (Example: channel 01)

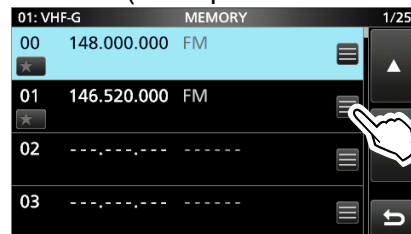

4. Touch “Edit Name.”

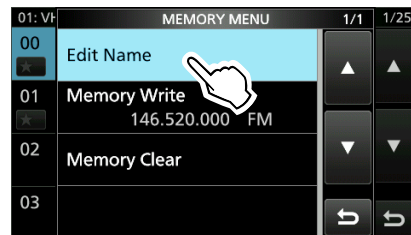

5. Enter a name, then touch [ENT].

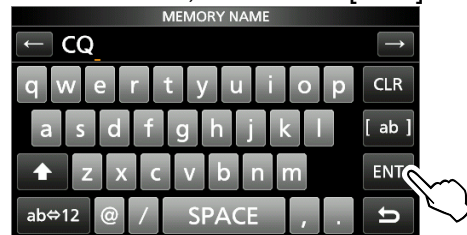

6. To close the MEMORY screen, push **EXIT** several times.

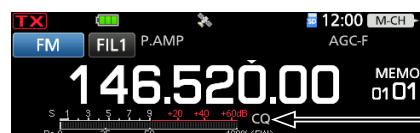

Memory name

- ① The Memory name is not displayed when the Mini Scope screen or expanded screen is displayed.
- ① You can also select not to display the Memory name on the standby screen.

MENU » **SET > Display > Memory Name**

7. MEMORY OPERATION

Clearing a Memory channel

You can clear a no-longer-used memory channel and reset it as a blank channel, except for the Call channels (C1 and C2).

1. Select the Memory mode. (Basic Manual)
2. Assign the Select Memory Channel function to **[MULTI]**. (Basic Manual)
3. Rotate **[MULTI]** to select the channel to clear. (Example: channel 01 in group 01)
4. Touch the VFO/MEMORY icon.

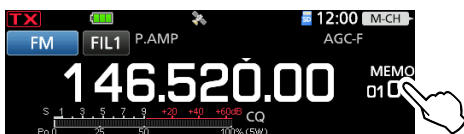

5. Touch **[M-CLR]** for 1 second.

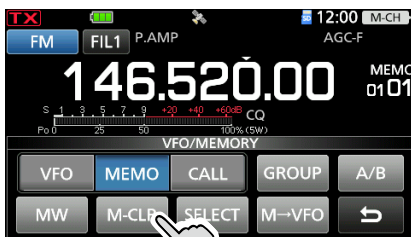

MEMORY screen

[MENU] » **MEMORY > Group 00 ~ 99, CALL CH**

You can edit Memory channel contents on the MEMORY screen.

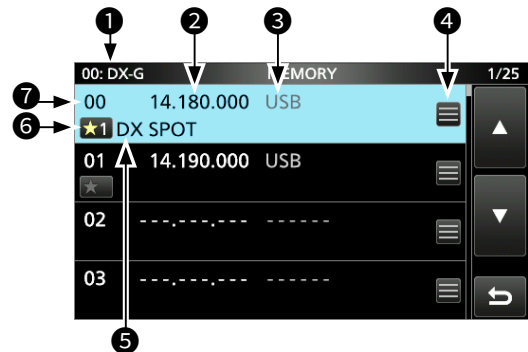

- 1 Group number: Group name**
Displays the group number (00 ~ 99) and name, if entered.
- 2 Frequency**
Displays the entered frequency.
- 3 Operating mode**
Displays the selected operating mode.
- 4 Memory menu**
Touch to display the MEMORY MENU screen.
① You can select “Edit Name,” “Memory Write,” or “Memory Clear.”
- 5 Memory name**
Displays the memory name, if entered.
① See page 7-4 for details.
- 6 Memory select icon (00 ~ 99)**
 - Touch this icon to set the Select number “★1,” “★2,” “★3,” or OFF.
① See page 8-7 for the Select Memory scan.
 - Touch the icon for 1 second to display the SELECT ALL CLEAR screen, and then select the desired item to reset the Select number.
- 7 Memory channel number**
Displays the memory channel number (00 ~ 99, C1, C2).
① C1 and C2 cannot be left blank.

TIP: About the QUICK MENU screen

While selecting a memory channel with memory contents, push **[QUICK]** to open the QUICK MENU screen. You can select SELECT, Edit Name, Memory Write, Memory Copy, Insert Channel, Move Channel, Memory Clear, Delete Channel, or SELECT All Clear.

7. MEMORY OPERATION

Memo Pad

There are 5 Memo Pads as the default to save frequencies and operating modes for easy writing and recall. You can increase the Memo Pads to 10 in the following item.

MENU » **SET > Function > Memo Pad Quantity**

① The Memo Pads are separate from memory channels.

Memo Pads are convenient when you want to temporarily memorize a frequency and operating mode, such as when you find a DX station in a pile-up, or when the desired station is busy for a long time and you want to temporarily look for other stations.

◇ Saving the contents into a Memo Pad

1. Select the VFO mode. (Basic Manual)
 2. Set the frequency and operating mode, then push **MPAD** for 1 second.
 - A beep sounds.
- ① When you save up to the set number of Memo Pads in "Memo Pad Quantity," the oldest Memo Pad is automatically cleared for the new Memo Pad.

NOTE: Each Memo Pad must have its own unique contents. The Memo Pads with identical content cannot be saved.

◇ Calling up the Memo Pads

1. Select the VFO mode. (Basic Manual)
2. Push **MPAD** several times until the desired Pad is displayed.
 - ① Pushing **MPAD** selects the Memo Pads.
 - ① The calling up starts with the most recently saved Pad.

◇ MEMO PAD screen

The MEMO PAD screen displays the saved contents in a list, in which you can select or delete the saved contents.

MENU » **MPAD**



TIP: If you change the frequency or operating mode called up from Memo Pads, the contents are automatically updated in a temporary Pad.

Key	Action	
▲/▼	Scrolls through the list.	
DEL	Touch for 1 second	Deletes the selected Memo Pad.
DEL ALL	Touch for 1 second	Deletes all the Memo Pads.
EXPAND	Select to display the MEMO PAD list in the Expanded or Normal screen.	

8. SCANS

Scan types

VFO SCAN Used to detect a signal by automatically changing the frequency of the VFO mode.
Programmed scan (p. 8-4) Repeatedly scans the Program scan edge ranges. The Edge frequencies are programmable. (p. 8-5)
Fine Programmed scan If the squelch opens while scanning, the tuning step changes to 10 Hz. This reduces the scan speed, but the transceiver keeps scanning.
MEMORY SCAN Used to detect a signal by automatically scanning the memories in the Memory mode.
Memory scan (p. 8-6) Repeatedly scans all entered Memory channels or Memory channels in the selected group.
Select Memory scan (p. 8-7) Repeatedly scans Select Memory channels.
Mode Select scan (p. 8-8) Repeatedly scans Memory channels with the same operating mode.
ΔF SCAN (p. 8-9) Repeatedly scans within the Δ F span area. The scan starts from the center frequency.
Fine ΔF scan If the squelch opens while Δ F scanning, the tuning step changes to 10 Hz. This reduces the scan speed, but the transceiver keeps scanning.

Preparation

◇ Squelch status

The scan works with the selected band's squelch status. Be sure to adjust the squelch level according to your operating environment.

- ① Normally, set the squelch level to the point where the noise just disappears and the TX/RX indicator goes OFF.

When the scan starts with the squelch open:

- When the tuning step is 1 kHz or less, the scan continues until it is manually stopped— it does not pause, even if signals are detected.
- When the tuning step is 5 kHz or more, the scan pauses on each step when the Scan Resume function is ON. It does not pause when the function is OFF.

When the scan starts with the squelch closed:

- The scan stops when a signal is detected, regardless of the tuning step.
- ① When the Scan Resume function is ON, the scan pauses for 10 seconds after detecting a signal, then resumes 2 seconds after the signal disappears.

8. SCANS

SCAN screen

Display the SCAN screen.

MENU » **SCAN**



VFO mode

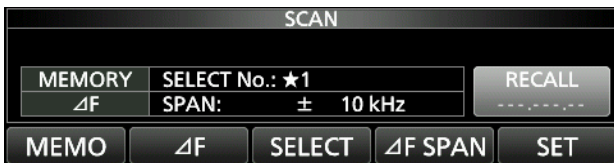

Memory mode

Key	Action	
PROG	Touch	Starts or cancels a Programmed scan.
	Touch for 1 second	Displays the SCAN SELECT screen.
MEMO	Touch	Starts or cancels a Memory scan.
	Touch for 1 second	Displays the SCAN SELECT screen.
ΔF	Starts or cancels a ΔF scan.	
FINE	While Programmed scanning, touch to switch to the Fine Programmed scan. While ΔF scanning, touch to switch to the Fine ΔF scan. ① In the Memory mode, this key is displayed when a ΔF scan is started.	
SELECT	Touch	Selects a Memory channel (except C1 and C2) to set as a Select Memory channel. • "★1," "★2," "★3," or "(no icon)"
	Touch for 1 second	Displays the SELECT ALL CLEAR screen.
SEL No.	Selects the Select scan number for the Select Memory scan. • "★1," "★2," "★3," or "★1,2,3"	
ΔF SPAN	Selects a ΔF span. • ±5.0 kHz, ±10 kHz, ±20 kHz, ±50 kHz, ±100 kHz, ±500 kHz, or ±1 MHz	
SET	Displays the SCAN SET screen.	

- Push **SCAN** to display the SCAN SELECT screen.
① If you push **SCAN** while scanning, the scan is canceled.
- Hold down **SCAN** for 1 second to start the previously selected scan.

8. SCANS

SCAN SET screen

1. Display the SCAN screen.

MENU » **SCAN**

2. Touch [SET].

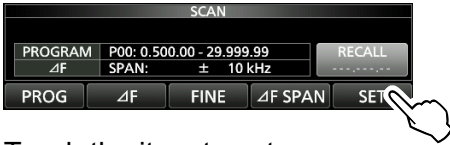

3. Touch the item to set.
(Example: SCAN Speed)

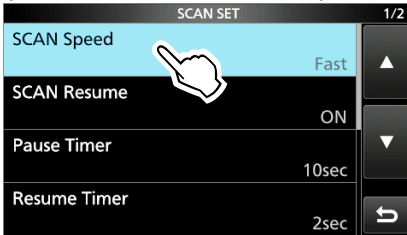

4. Touch the option to set. (Example: Slow)

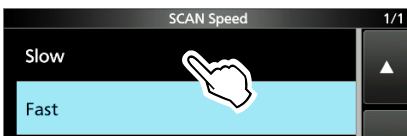

5. To close the SCAN SET screen, push **EXIT**.

TIP: You can set each item to its default by touching the item for 1 second, and then touching "Default" on the QUICK MENU screen.

SCAN Speed (Default: Fast)

Sets the desired scan speed to slow or fast.

- Slow: Scan speed is slow.
- Fast: Scan speed is fast.

SCAN Resume (Default: ON)

Sets the Scan Resume function to ON or OFF.

- OFF: When a signal is detected, cancels the scan.
- ON: When a signal is detected, the scan pauses for 10 seconds, then resumes. Two seconds after the signal disappears, the scan resumes.

Pause Timer (Default: 10sec)

When Scan Resume is ON, selects the Scan Pause Timer. When receiving a signal, the scan pauses for this set period of time.

- 2 ~ 20sec: When a signal is received, the scan pauses for 2 ~ 20 seconds (in 2 second steps).
- HOLD: The scan pauses on a received signal until the signal disappears.

Resume Timer (Default: 2sec)

Selects the scan Resume Timer. When a received signal disappears, the scan resumes after this set period of time passed.

- 0sec: The scan resumes immediately after the signal disappears.
- 1 ~ 5sec: The scan resumes 1 ~ 5 seconds after the signal disappears.
- HOLD: The scan remains paused for the Pause Timer setting, even if the signal disappears.

Temporary Skip Timer (Default: 5min)

Sets the Temporary Skip Timer. The unwanted frequencies that are set as Skip channels (PSKIP or SKIP) are skipped for this set period of time during a scan.

① This timer is activated for the VFO scan, Memory scan, and DR scan.

- 5min/10min/15min: Skip channels are skipped for the set period of time.
- While Scanning: Skip channels are skipped until the scan is stopped.
- While Powered ON: Skip channels are skipped until the transceiver is turned OFF.

MAIN DIAL Operation (SCAN) (Default: Up/Down)

Selects the function of **MAIN DIAL** while scanning.

- OFF: Rotating **MAIN DIAL** stops the scan.
- Up/Down: Rotating **MAIN DIAL** changes the scanning direction.

Program Scan Edge

You can delete, copy, or edit the lower and higher frequencies for programmed scans.

The transceiver has a total of up to 25 frequency ranges (00 ~ 24), and you can set the scan name, mode, and the IF filter for each Scan Edge.

① The default setting may differ, depending on the transceiver version.

① See page 8-5 for entering Scan Edges.

Programmed scan and Fine Programmed scan

Repeatedly scans the Program Scan Edge ranges.

① To change the upper and lower frequency, see page 8-5 for details.
 ① If the same frequencies are entered into the upper and lower frequency, the Programmed scan does not start.
 ① The Fine Programmed scan is most effective in the SSB, CW, and RTTY modes.

◇ Programmed scan operation

1. Select the VFO mode.
2. Select the operating mode and tuning step. (Example: USB, 1 kHz)
3. Display the SCAN screen.

MENU » **SCAN**

4. Touch [PROG] for 1 second.

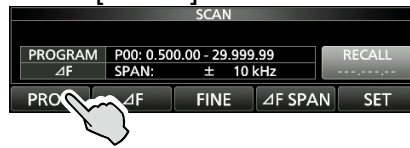

5. Touch the frequency range to scan. (Example: P00)

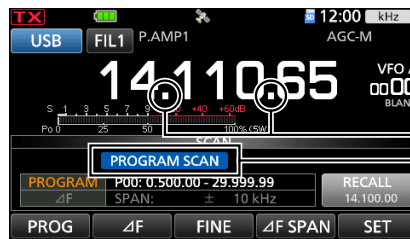
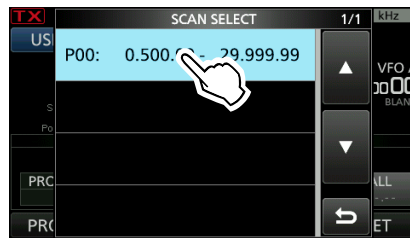

Blinks
Blinks

- The Programmed scan starts.
 - ① When a signal is detected, the scan pauses according to the “SCAN Resume” setting, and then resumes.
 - ① You can change the tuning step by touching kHz.
 - ① To cancel the scan, touch [PROG].
6. To switch to the Fine Programmed scan, touch [FINE].

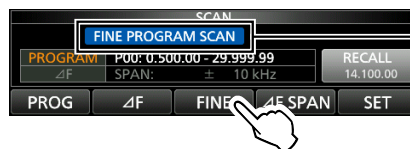

Blinks

- The tuning step changes to 50 Hz steps.
 - ① When a signal is detected, the tuning step changes to 10 Hz steps.
 - ① To return to the Programmed scan, touch [FINE] again.
7. To close the SCAN screen, push **EXIT**.

8. SCANS

Entering Scan Edges

You can enter the upper and lower frequency edges to the Program Scan Edge ranges for Program scans. Each Program Scan Edge range has its own name, mode, and IF filter settings. You can enter a total of up to 25 Program Scan Edge ranges.

① The default setting may differ, depending on the transceiver's version.

1. Display the SCAN SET screen.

MENU » **SCAN > SET**

2. Touch "Program Scan Edge."

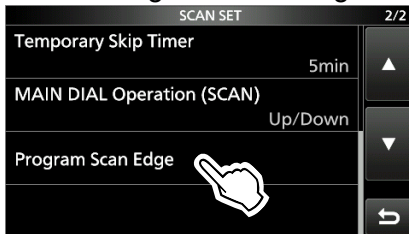

3. Touch the channel that you want to enter, for 1 second. (Example: 00)

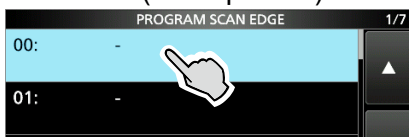

4. Touch "Edit."



5. Touch "NAME."

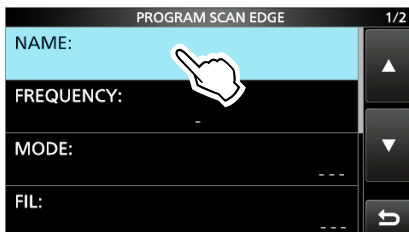

6. Enter a name, then touch [ENT].

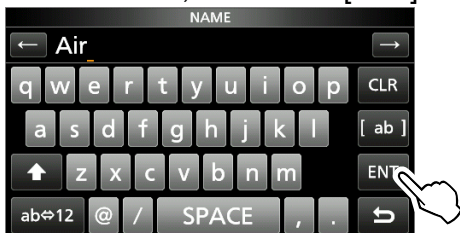

7. Touch "FREQUENCY."

8. Enter the upper and lower edge frequency, then touch [ENT].

Entry example: [1] [1] [8] [ENT] [1] [3] [6] [ENT]



- ① Touch **◀▶** to select the upper and lower edge frequency, and then rotate **ⓂMULTI** or touch the keypad to edit the frequency.

9. Touch "MODE."

10. Touch the mode to be used during a scan. (Example: AM)

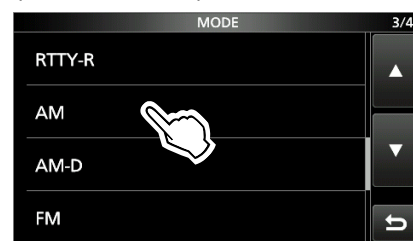

① When you select "---," the mode set in the VFO mode is used during a scan.

① When you select "WFM," you cannot select "FIL."

11. Touch "FIL."

12. Touch the IF filter number to be used during a scan. (Example: FIL 1)

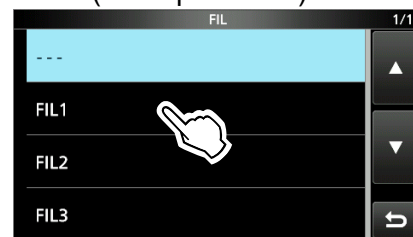

13. Touch "<<Write>>."

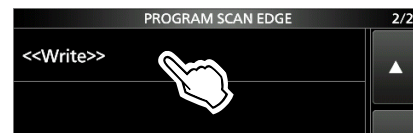

14. Touch [YES].

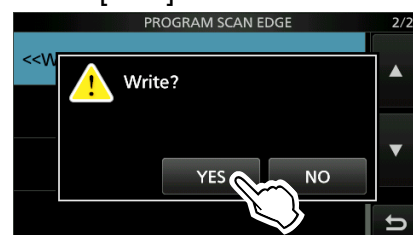

- A beep sounds, and the Program Scan Edge ranges are entered.
- Returns to the PROGRAM SCAN EDGE screen.

Memory scan

Repeatedly scans all entered Memory channels (except C1 and C2).
Blank (not entered) Memory channels are skipped.

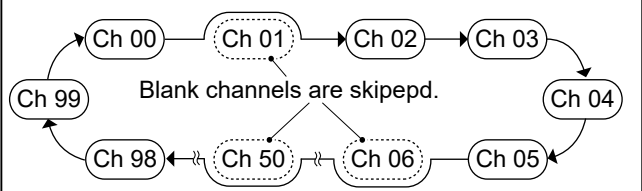

① If two or more Memory channels are not entered, the Memory scan does not start.

◇ Memory scan operation

1. Select the Memory mode.
2. Display the SCAN screen.

MENU » **SCAN**

3. Touch [MEMO] for 1 second.

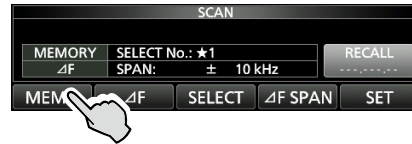

4. Touch "ALL MEMORY SCAN."

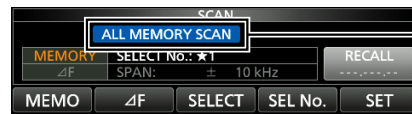
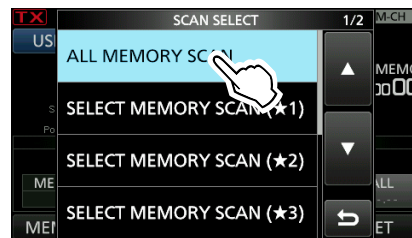

- The All Memory scan starts.
 - ① When a signal is detected, the scan pauses according to the "SCAN Resume" setting, and then resumes.
 - ① To cancel the scan, touch [MEMO].
5. To close the SCAN screen, push **EXIT**.

TIP: Touch GROUP 00 ~ 99 in step 4 to scan through the Memory channels in the selected group. (Example: GROUP 00)

Select Memory scan

Repeatedly scans Select Memory channels (★1, ★2, ★3).

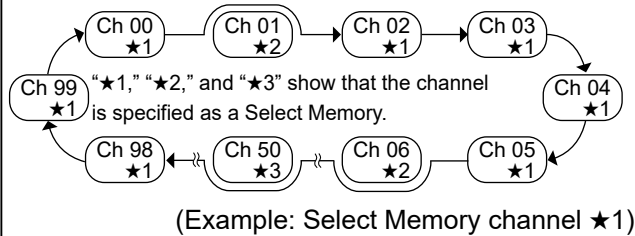

① If two or more Memory channels are not designated as Select Memory channels, the Select Memory scan does not start.

Setting the Select Memory channels

1. Select the Memory mode.
2. Display the SCAN screen.
[MENU] » [SCAN]
3. Rotate [MULTI] to select memory channels to set as Select Memory channels.
4. Touch [SELECT] to set the selected number.
① Each touch selects “★1,” “★2,” “★3,” and “(no icon).”

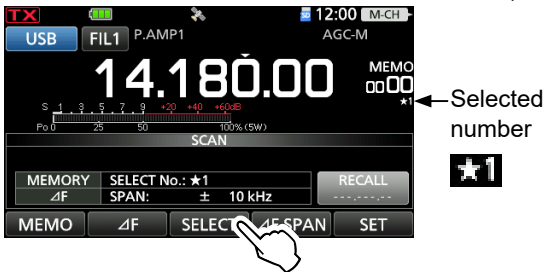

5. Repeat steps 3 and 4 to set more than two Select Memory channels.

TIP: Setting Select Memory channels on the MEMORY screen.

1. Display the MEMORY screen.
[MENU] » [MEMORY > Group 00 ~ 99]
2. Touch the SELECT icon to set the channel as the Select Memory channel. (Example: ★1)
① Each touch selects “★1,” “★2,” “★3,” and “(no icon).”
Touch to set the channel as a Select Memory channel.
• “★1” is set to Memory channel 00.



Select Memory scan operation

1. Select the Memory mode.
2. Display the SCAN screen.
[MENU] » [SCAN]
3. Touch [MEMO] for 1 second.

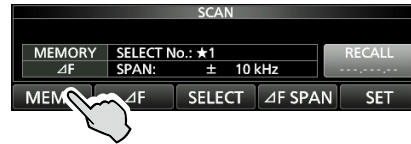

4. Touch the Select Memory channel number. (Example: ★1)

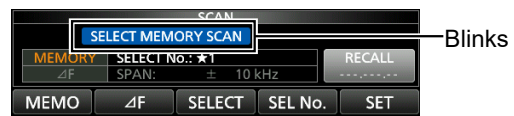
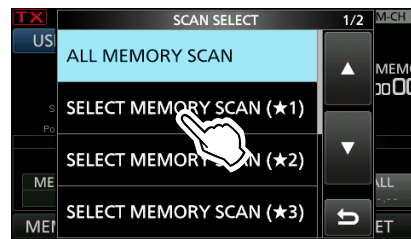

- The Select Memory scan starts.

Information

- When a signal is detected, the scan pauses according to the “SCAN Resume” setting, and then resumes.
- To return to the regular Memory scan, touch [SELECT].
- While scanning, touch [SEL No.] to select the Select Memory scan number.
- To cancel the scan, touch [MEMO].

5. To close the SCAN screen, push [EXIT].

Clearing all Select Memory channels

1. Touch [SELECT] for 1 second on the SCAN screen.
• The SELECT ALL CLEAR screen is displayed.
2. Touch the Select Memory channel number to clear.

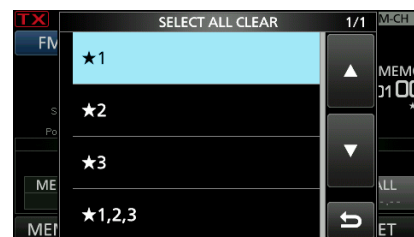

Mode Select scan

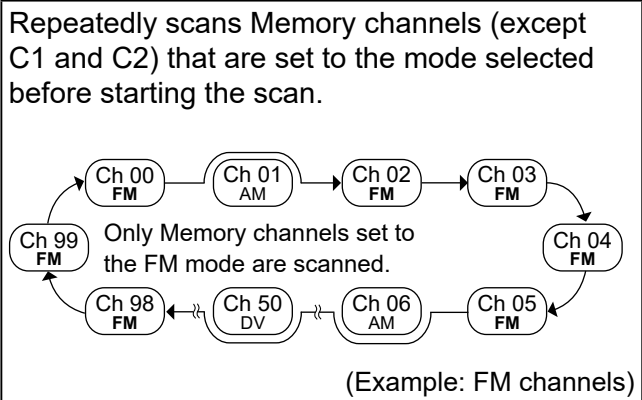

◇ Mode Select scan operation

1. Select the Memory mode.
2. Set the operating mode.
3. Display the SCAN screen.

MENU » **SCAN**

4. Touch [MEMO] for 1 second.

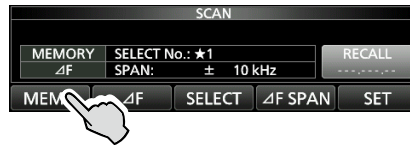

5. Touch "MODE SELECT SCAN."

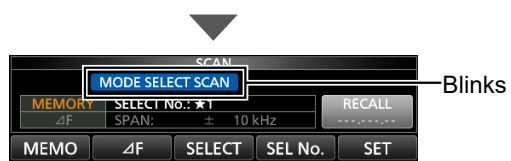
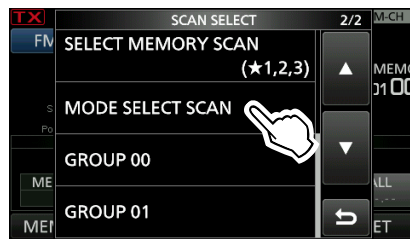

- The Mode Select scan starts.
 - ① When a signal is detected, the scan pauses according to the "SCAN Resume" setting, and then resumes.
 - ① To cancel the scan, touch [MEMO].
6. To close the SCAN screen, push **EXIT**.

ΔF scan and Fine ΔF scan

Repeatedly scans within the ΔF span area. The scan starts from the center frequency.

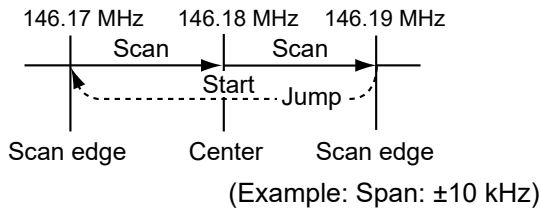

① In a Fine scan (Programmed or ΔF), the scan speed decreases when the squelch opens, but the transceiver keeps scanning. The scan tuning step changes to 10 Hz when the squelch opens.

◇ ΔF scan operation

1. Set the center frequency.
2. Set the operating mode and tuning step.
(Example: FM, 1 kHz)
① You can also change these settings while scanning.
3. Display the SCAN screen.
[MENU] » **[SCAN]**
4. Touch [ΔF SPAN] several times to select the span.

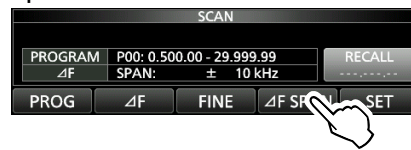

• Each touch changes the span.

5. Touch [ΔF].

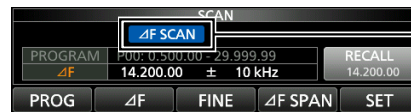
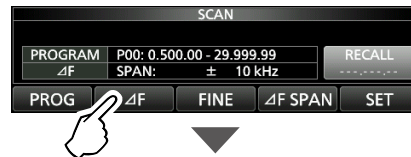

• The ΔF scan starts.

- ① When a signal is detected, the scan pauses according to the “SCAN Resume” setting, and then resumes.
- ① To turn the TS function to scan by the frequency step setting, touch the 100 kHz digit on the frequency readout.
- ① To cancel the scan, touch [ΔF] again.

6. To switch to the Fine ΔF scan, touch [FINE].

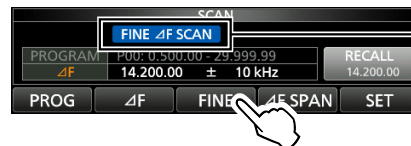

• The scan frequency step changes to 50 Hz.

- ① To return to the ΔF scan, touch [FINE] again.
7. To close the SCAN screen, push **[EXIT]**.

8. SCANS

Temporary Skip function

This function temporarily skips unwanted frequencies (or memory channels) during a scan for the set period of time or condition, without changing the Skip Channel setting.

1. Start a scan.
 - When a signal is detected, the scan pauses.
2. Push **QUICK**.
3. Touch “Temporary Skip Set.”

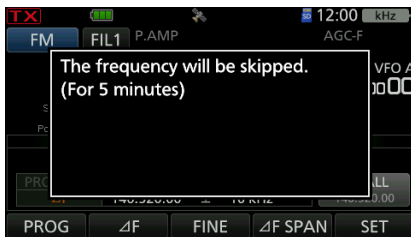
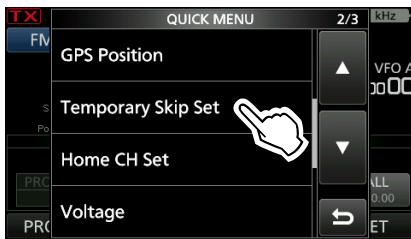

- Scan resumes.

TIP:

- Up to 20 Temporary Skip frequencies or Memory channels can be set. When the 21st frequency or Memory channel is set, the oldest setting is automatically deleted.

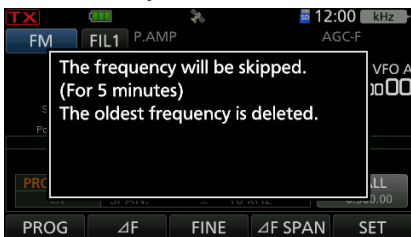

- The Temporary Skip function is canceled when the Temporary Skip Timer (Default: 5 min) has passed, or when touching “Temporary Skip Cancel” in the QUICK MENU screen.

9. OTHER FUNCTIONS

About “USB SEND/Keying”

You can control transmit, receive, and CW/RTTY keying from the PC through the USB port. Select the control port to be used for communication between the transceiver and PC in “USB SEND,” “USB Keying (CW),” and “USB Keying (RTTY)” according to your operating needs.

MENU » **SET > Connectors > USB SEND/Keying**

The IC-705 has two virtual COM ports, A and B. The transmit and receive control (USB SEND), CW Keying, or RTTY (FSK) Keying signals from the PC are assigned to the DTR/RTS terminals in the virtual port.

① When connecting to a USB port on your PC that is installed the USB driver, USB (A) and USB (B) are named as “IC-705 Serial Port A (CI-V)” and “IC-705 Serial Port B.”

USB SEND (Default: OFF)
USB Keying (CW) (Default: OFF)
USB Keying (RTTY) (Default: OFF)

- OFF: Turns OFF the function.
- USB (A) DTR: Uses the DTR terminal on USB (A).
- USB (A) RTS: Uses the RTS terminal on USB (A).
- USB (B) DTR: Uses the DTR terminal on USB (B).
- USB (B) RTS: Uses the RTS terminal on USB (B).

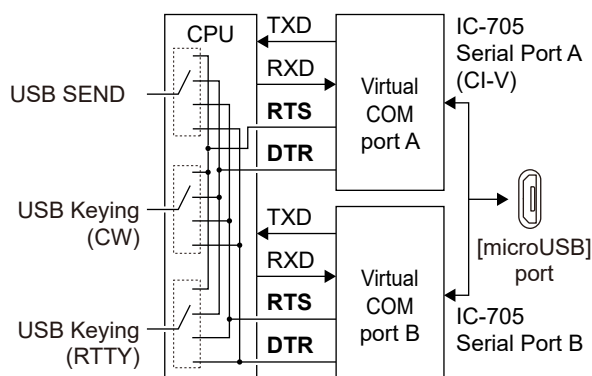

TIP: About the “USB SEND/Keying” items

- When you operate RTTY or CW through your PC’s USB port and your IC-705, you may not be able to send the “SEND” or “Keying” signals until a few seconds after you connect the USB cable.
- When you operate through your PC’s USB port and the IC-705, and connect a second transceiver to another PC USB port, a short “SEND” or “Keying” signal will be sent from the first transceiver. Therefore, we recommend that you do not connect a second transceiver to a USB port of the same PC. Or, always turn OFF the transceiver power before you connect a USB cable.

Protection function

The transceiver has a 2 step protection function to protect the final power amplifiers in case the antenna SWR becomes high. The function detects the power amplifier temperature and activates when the temperature becomes too high.

Power down transmission

Reduces the transmission output power.

TX inhibit

Disables the transmitter.

- **TX** (Grayed out) is displayed instead of **TX** while the transmitter is disabled.

NOTE: If the function is activated, wait until the power amplifier cools down by using the transceiver only to receive.

- You can check the power amplifier temperature with the TEMP gauge in the Multi-function meter.

Measuring SWR

The transceiver has a high-performance SWR meter. This meter displays a stable measurement in real time, even if the transmit output power varies frequently.

There are 2 ways to measure SWR. One way is a spot measurement, and the other is a plot measurement.

① When you measure the SWR of an antenna itself, turn OFF any connected antenna tuner.

◇ Spot measurement

1. Turn OFF any connected antenna tuner.
 - ① Perform this step if an antenna tuner is connected, and you want to measure the SWR of the antenna itself.
2. Set the desired frequency band and a frequency in the portion of the band that you use the most.
3. Select the RTTY mode.
4. Set the RF power to more than 5 W.
5. Touch the TX meter several times until the SWR meter is displayed.

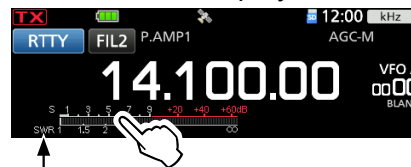

“SWR” is displayed.

NOTE: Before transmitting, monitor the operating frequency to make sure you will not cause interference to other stations on the same frequency.

6. Hold down [PTT] to transmit, and then read the SWR on the meter.

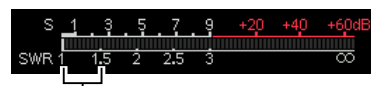

The best match is within this range.
(1.5 or less)

- ① If the SWR meter indicates 1.5 or less, the antenna is matched.
- ① If the SWR is a high value, adjust your antenna.
7. Release [PTT] to stop transmitting.

9. OTHER FUNCTIONS

Measuring SWR

◇ Plot measurement

You can measure the SWR over the entire set frequency range.

1. Set the desired frequency band.
2. Set the RF power to more than 5 W.
3. Display the SWR GRAPH screen.
[MENU] » [SWR]
4. Set the center frequency for the SWR to measure. (Example: 14.080.00)
5. Touch **[STEP]** several times to set the measuring step, or touch **[BAR]** several times to set the number of graph bars.

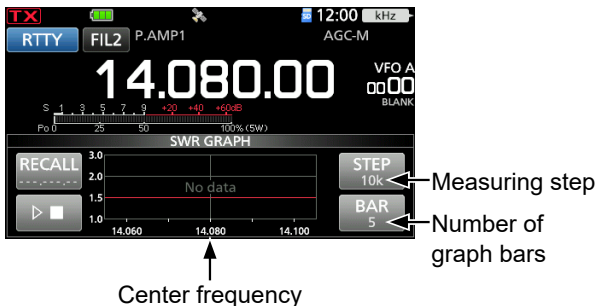

- ① You can select between 10, 50, 100, and 500 kHz measuring steps.
- ① You can select between 3, 5, 7, 9, 11, and 13 graph bars.

6. Touch **[▶]** to start measuring.
 - Displays the frequency marker “▲” and the measurement frequency.

NOTE: Before transmitting, monitor the operating frequency to make sure you will not cause interference to other stations on the same frequency.

7. Hold down **[PTT]** to transmit.
 - The bar graph displays the SWR.
 - ① When the Break-in function is ON in the CW mode, you can use a straight key or paddle to transmit.

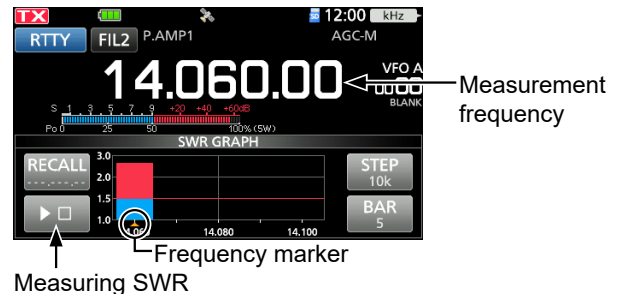

8. Release **[PTT]** to stop transmitting.
 - ① When using a straight key or paddle, stop keying.
9. Repeat steps 7 and 8 to measure the SWR over the entire frequency range.

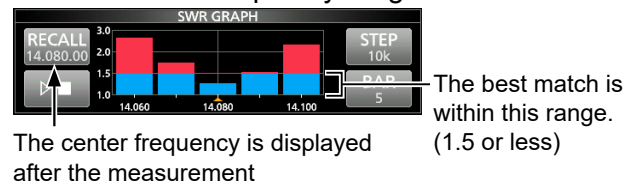

TIP:

- Rotate **[MAIN DIAL]** to move the frequency marker “▲” to the current transmit frequency.
- “<<” (low) or “>>” (high) is displayed when the transmitted frequency is out of the displayed range.
- Touch **[RECALL]** for 1 second to move the frequency marker “▲” back to the center frequency.
- Touch the bar graph to delete the measured SWR.

NTP function

The Network Time Protocol (NTP) function synchronizes the internal clock with a time management server.

① To use this function, an internet connection and default gateway settings are necessary.

◇ Using the NTP Time Synchronize function

Using this function, you can manually synchronize the internal clock by accessing a time management server.

1. Open the DATE/TIME screen.

MENU » **SET > Time Set > Date/Time**

2. Touch “<<NTP TIME SYNC>>.”

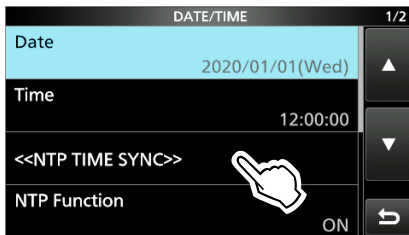

- “NTP Time Sync. Please wait...” is displayed.
- The transceiver starts accessing the NTP server address that is set in “NTP Server Address.”

3. When “Time Sync completed.” is displayed, touch [OK].
4. To close the DATE/TIME screen, push **EXIT** several times.

◇ Using the NTP function

By turning ON the NTP function, the transceiver automatically synchronizes the internal clock with the time management server.

① This function is set to ON by default.

1. Open the DATE/TIME screen.

MENU » **SET > Time Set > Date/Time**

2. Touch “NTP Function.”

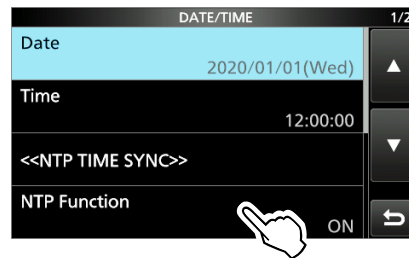

3. Select ON or OFF.

- When ON is selected, the transceiver starts accessing the NTP server address that is set in “NTP Server Address.”

4. To close the DATE/TIME screen, push **EXIT** several times.

Screen Capture function

You can capture the transceiver display onto a microSD card. Most of the screens used in this manual are captured using this function. However, some displays cannot be captured.

◇ Setting the Screen Capture function

1. Open the “Screen Capture [POWER] Switch” screen.

MENU » SET > Function
 > **Screen Capture [POWER] Switch**

2. Touch “ON.”

◇ Capturing a screen

1. Display the desired screen to capture.
 2. Push **POWER** to capture the screen.
 - The captured screen is saved onto the card.
- ① When “Screen OFF [POWER] Switch” is set to ON, the dialog to select “Screen OFF” or “Screen Capture” is displayed.

◇ Viewing the captured screen

1. Open the SCREEN CAPTURE VIEW screen.
MENU » SET > SD Card > **Screen Capture View**
 - The capture list is displayed.
 - The latest screen capture is at the top of the list.
2. Touch the desired screen capture to display it.

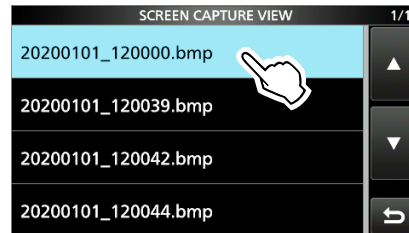

- The screen capture is displayed.
- ① While a screen capture is displayed, you can scroll through all the screen captures by rotating **MULTI**.

Checking the file information and deleting a file

1. Touch the screen capture that you want to view or delete for 1 second.

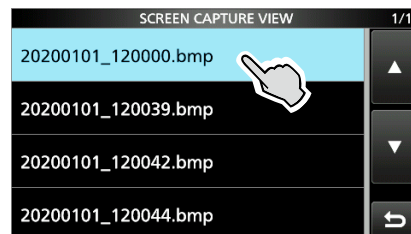

2. Touch an item from “File Information,” “Delete,” and “Delete All.”

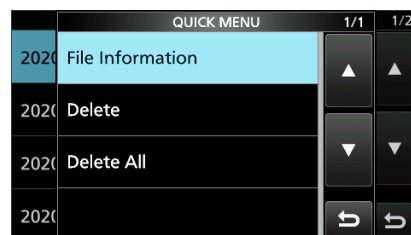

- File Information: Displays the file name, size, and date of the selected screen capture.
- Delete: Deletes the selected file.
- Delete All: Deletes all files.

9. OTHER FUNCTIONS

Entering DTMF code

The transceiver can save up to 16 memories of 24 digit DTMF code.

1. Display the DTMF screen.

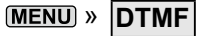

2. Touch [EDIT].

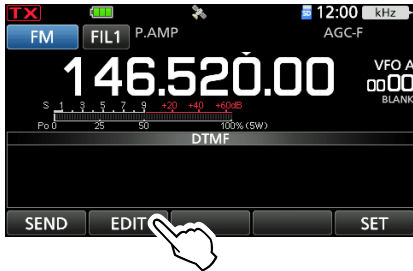

3. Touch the DTMF channel where you want to save a DTMF code. (Example: d0)

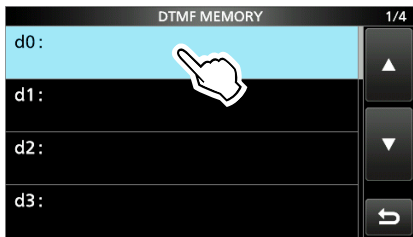

4. Enter a DTMF code, then touch [ENT]. (Example: 123456A)



5. To close the DTMF MEMORY screen, push [EXIT].

Transmitting the DTMF code

◇ Transmitting a DTMF code

1. Display the DTMF screen.

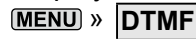

2. Touch [SEND].

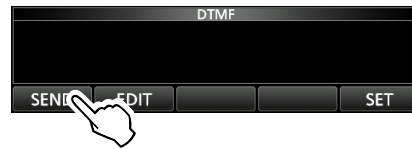

3. Touch the DTMF code you want to transmit. (Example: d0)

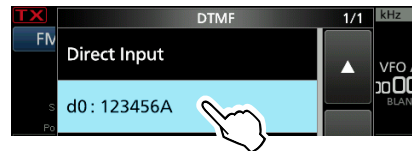

- Transmits the selected DTMF code.

4. To close the DTMF screen, push [EXIT].

◇ Transmitting a DTMF code (Direct Input)

1. Display the DTMF screen.

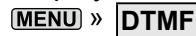

2. Touch [SEND].



3. Touch "Direct Input."

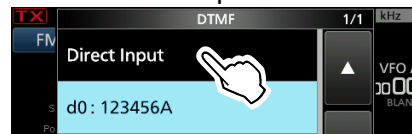

4. Enter a DTMF code, then touch [TX]. (Example: 012345#)



- Transmits the entered DTMF code.

5. To close the DTMF screen, push [EXIT].

9. OTHER FUNCTIONS

Transmitting the DTMF code

◇ Selecting the DTMF transmit speed

1. Display the DTMF screen.

MENU » **DTMF**

2. Touch [SET].

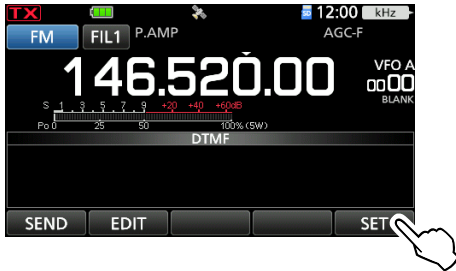

3. Touch “DTMF Speed.”

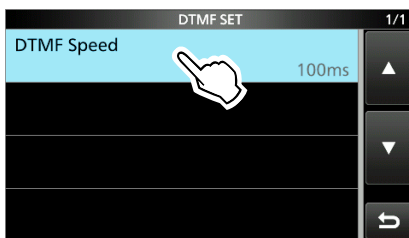

4. Touch the option to set. (Example: 300ms)

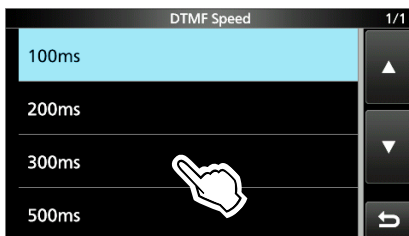

- 100ms: Transmits the DTMF tones at about 100 milliseconds per code (5 characters per second).
- 200ms: Transmits the DTMF tones at about 200 milliseconds per code (2.5 characters per second).
- 300ms: Transmits the DTMF tones at about 300 milliseconds per code (1.6 characters per second).
- 500ms: Transmits the DTMF tones at about 500 milliseconds per code (1 character per second).

5. To close the DTMF SET screen, push **EXIT**.

Home Channel function

Home Channels are often-used frequencies you can be preset in the transceiver’s VFO mode, Memory mode, and DR screen.

◇ Home Channel setting

Example: In the VFO mode

1. Select a mode (VFO or Memory) or the DR screen in which you want to set the Home Channel.
2. Select a frequency, channel, or a repeater to be set as the Home Channel.
① On the DR screen, select “FROM.”
3. Push **QUICK**.
4. Touch “Home CH Set.”

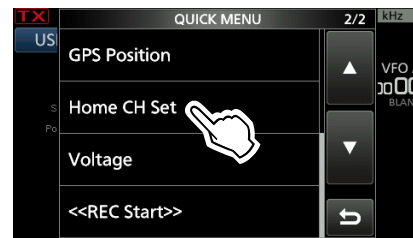

5. Touch “Set Frequency.”

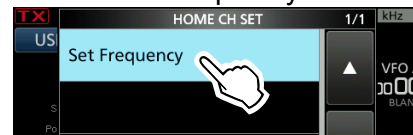

① In the Memory mode, touch “Set Channel.” On the DR screen, touch “Set Repeater.”

TIP: Touching “Clear” in Step 4 clears the Home Channel setting.

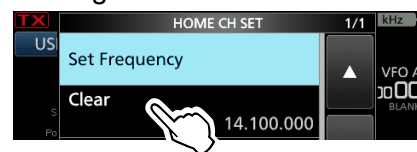

◇ Home CH Beep function

When the set Home Channel is selected, a beep sounds. You can confirm the Home Channel selection without looking at the display.

① You can turn OFF the Home CH Beep function.

MENU » **SET > Function > Home CH Beep**

Share Pictures function

With this function, you can send a picture and view a received picture, even if you do not use the software application.

① See “About the Share Pictures function” that can be downloaded from the Icom website.

9. OTHER FUNCTIONS

Setting the Opening picture

You can set a picture that is displayed at power ON.

NOTE: To set the displayed picture, a microSD card (user supplied) is required.

About a picture file to use

- File type: 24 bit bitmap
(The file extension is “bmp.”)
- Picture size: 480 x 272 (px)
- File name: Up to 23 characters
(except the filename extension)

Step 1. Saving a picture on the microSD card (PC)

1. Copy a picture file into the “IC-705” > “OpeningPicture” folder on the microSD card.
① See page 4-5 for detail.
2. Insert the microSD card into the transceiver.

Step 2. Setting the displayed picture (Transceiver)

1. Open the OPENING PICTURE screen.
MENU » **SET > SD Card > Opening Picture**
2. Touch a picture to display.

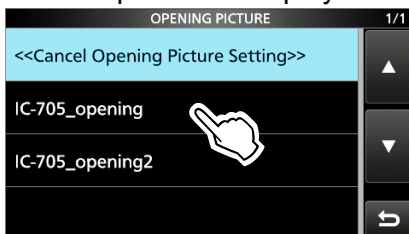

3. Touch **[SET]**.



- ① Touch **[u]** to select the picture again.
4. Touch **<YES>**.
 - The transceiver will automatically restart, and the selected picture is displayed.

To hide the picture at power ON

Touch “<<Cancel Opening Picture Setting>>” in step 2.

- ① The selected picture can be displayed even if:
- No microSD card is inserted.
 - You do a Partial Reset or All Reset.

10. Bluetooth® OPERATION

Bluetooth® operations

You can connect Bluetooth devices to the transceiver, using the Bluetooth function.

Icom Headset

When you connect the VS-3 Bluetooth® HEADSET to the transceiver, you can wirelessly transmit and receive.

The VS-3 has a [PTT] switch, so you can transmit in the same way as using the transceiver's [PTT] switch. The VOX function can also be used, so you can select transmit and receive by using your voice through the headset to switch between TX and RX.

You can assign a function to the keys on the side panel of the VS-3 to remotely operate the transceiver.

Android™ device

When you connect an Android device to the transceiver, you can use the extended D-STAR functions with the RS-MS1A (freeware Android application).

① The communication range of Bluetooth is approximately 10 meters (33 feet).

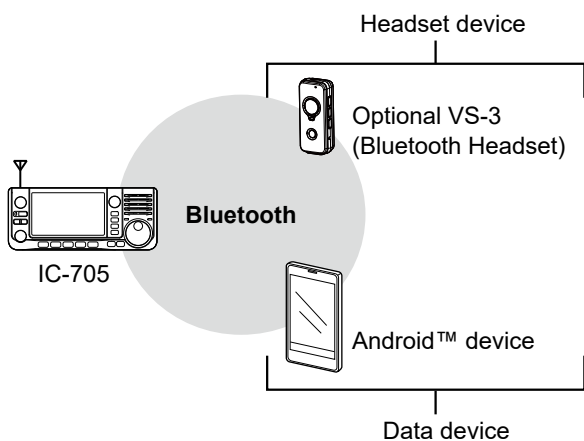

Turning ON the Bluetooth® function

1. Open the BLUETOOTH SET screen.

MENU » **SET > Bluetooth Set**

2. Touch "Bluetooth."

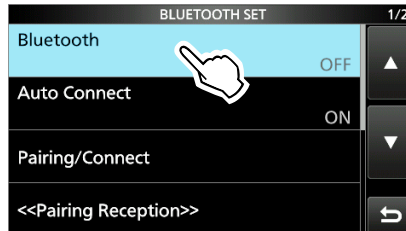

3. Touch "ON."

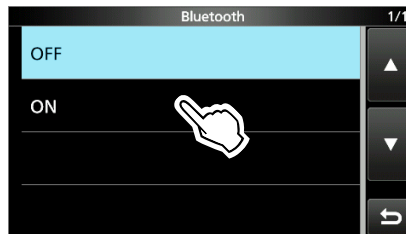

4. To close the BLUETOOTH SET screen, push **EXIT** several times.

IMPORTANT: The Bluetooth communication range may vary, depending on the environment in which the device operates. Microwave ovens or Wireless LAN may cause interference. In that case, stop using those devices or increase the space between the Bluetooth device and the other devices. All Bluetooth devices have a range of use. If the communication is unstable, use the device within the range.

Connecting to a Bluetooth® headset

You can connect an optional Bluetooth headset to the transceiver.

Step 1. Selecting the pairing mode of the headset.

See the instruction manual of the headset to select the pairing mode.

Step 2. Searching for the headset (Transceiver)

1. Open the PAIRING/CONNECT screen.
MENU » SET > Bluetooth Set > Pairing/Connect

2. Touch “Device Search.”



3. Touch “Search Headset.”



- Displays the usable headsets in the pairing list.

4. Touch the device name that you want to connect to. (Example: ICOM BT-002)

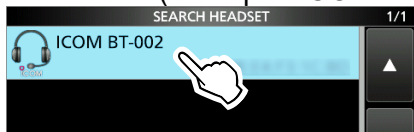

- The confirmation dialog “Connect?” is displayed.

5. Touch [YES].

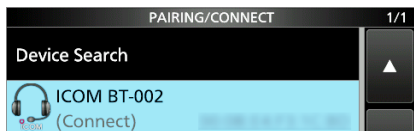
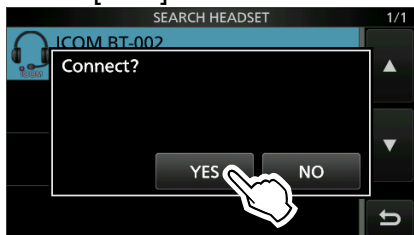

- Connects the headset.
- After connecting, “(Connect)” is displayed in the pairing list.

6. To close the PAIRING/CONNECT screen, push EXIT several times.

- ① While connected to a Bluetooth device, the Bluetooth icon is displayed.
- ① When “AF Output” is set to “Headset Only” and the Bluetooth connection is accidentally disconnected, a dialog is displayed to select whether or not to output the audio from the transceiver’s speaker. (p. 10-3)

Pairing List

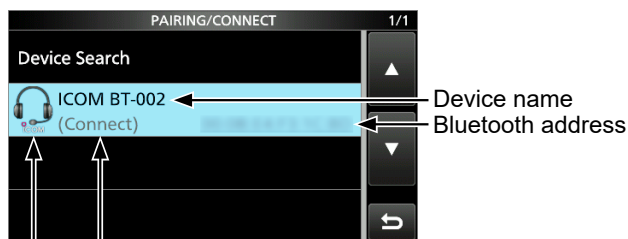

Headset icon (“ICOM” indicates the Icom headset.)
 Displayed while connected

TIP:
How to automatically connect to the paired device
 When you turn ON the transceiver with “Auto Connect” set to “ON,” the transceiver automatically connects to the last paired device. (Default: ON)
MENU » SET > Bluetooth Set > Auto Connect

- After connecting, the following dialog is displayed.

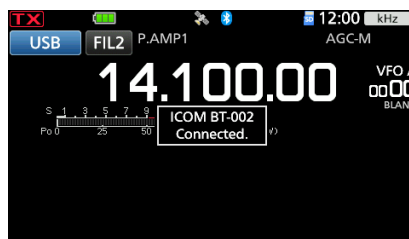

How to search again for a headset
 When the transceiver cannot find a connectable headset, “No Device Found” is displayed on the screen. To search again for a headset, push QUICK, and then touch “Re-search.”

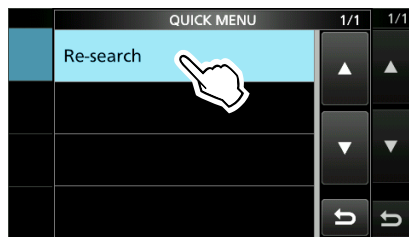
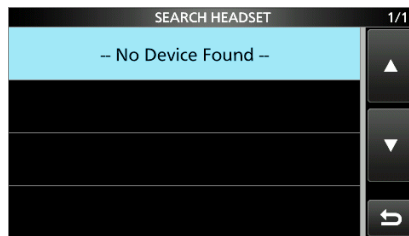

Bluetooth® Settings

◇ AF Output

You can select the AF Output device. If “AF Output” is set to “Headset & Speaker,” you can hear audio from both a connected Bluetooth headset and the transceiver’s speaker.

1. Open the HEADSET SET screen.
[MENU] » **SET > Bluetooth Set > Headset Set**

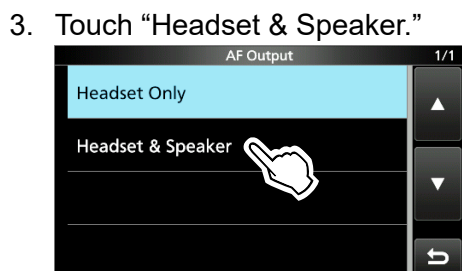
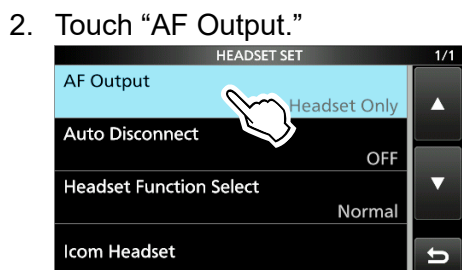

2. Touch “AF Output.”
3. Touch “Headset & Speaker.”
4. To close the HEADSET SET screen, push **[EXIT]** several times.
 ① Audio is heard from both the connected Bluetooth headset and the transceiver’s speaker.

TIP: When “AF Output” is set to “Headset Only,” the following dialog is displayed if the Bluetooth connection is accidentally disconnected.

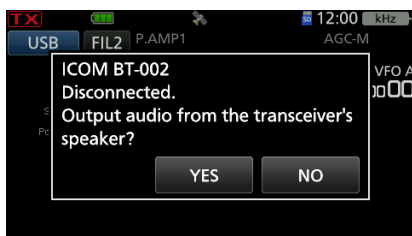

- [YES]: The audio is output from the transceiver’s speaker.
- [NO]: The transceiver’s volume level is automatically set to 0%, and the audio is not output from the transceiver’s speaker.

◇ Headset Function Select

You can select the PTT and microphone combination when either a Bluetooth headset or the transceiver microphone are used.

1. Open the HEADSET SET screen.
[MENU] » **SET > Bluetooth Set > Headset Set**

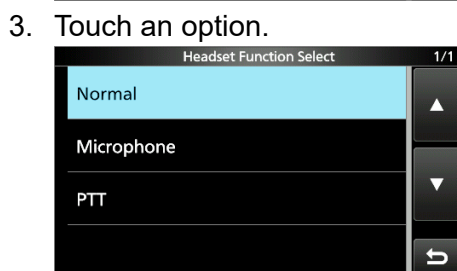
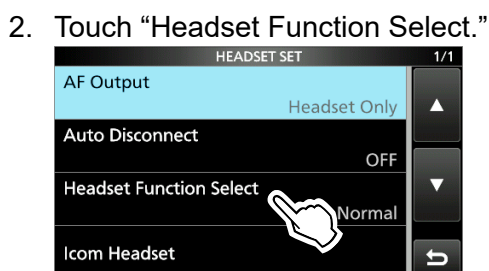

3. Touch an option.
4. To close the HEADSET SET screen, push **[EXIT]** several times.

NOTE: DO NOT select “PTT” when you use only the Bluetooth headset.

Select “Microphone”

Using the Bluetooth headset as a microphone.

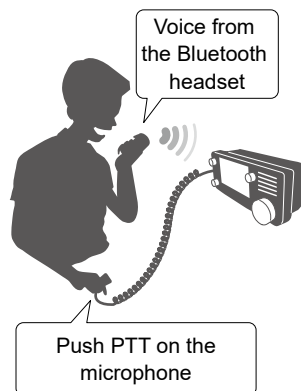

Select “PTT”

Using the Bluetooth headset as a PTT switch.



10. Bluetooth® OPERATION

Bluetooth® Settings

◇ About the Icom headset

You can set the detailed settings of the optional VS-3 Bluetooth® HEADSET.

Also, you can assign a key function to [PLAY], [FWD], and [RWD] on the “Custom Key” screen.

① See the Basic Manual for details on the setting items and their options.

MENU » SET > Bluetooth Set > Headset Set
> Icom Headset

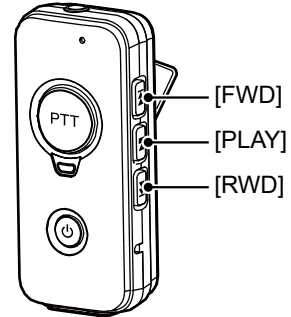

Optional VS-3
Bluetooth® HEADSET

Power Save screen

The Power Save function temporarily disconnects the Bluetooth connection if no communication or operation is performed for 120 seconds.

The Power Save function is disabled when the VOX function is ON.

One-Touch PTT screen

The One-Touch PTT function enables you to push [PTT] to transmit, and then push again to return to receive.

PTT Beep screen

Set a beep to sound when you push [PTT] on the VS-3.

Custom Key Beep screen

Set a beep to sound when you push [PLAY], [FWD], or [RWD] on the VS-3.

Custom key screen

You can assign a key function to [PLAY], [FWD], and [RWD] on the VS-3.

Pairing with an Android™ device

Before connecting to an Android™ device, you must pair with it.

This section describes how to pair with an Android device.

See page 14-37 about connecting to the transceiver with an Android device using the RS-MS1A application.

NOTE: Depending on the Bluetooth device, you may not be able to pair with it.

Step 1. Entering the Pairing Reception mode (Transceiver)

1. Open the BLUETOOTH SET screen.

MENU » **SET > Bluetooth Set**

2. Touch “<<Pairing Reception>>.”

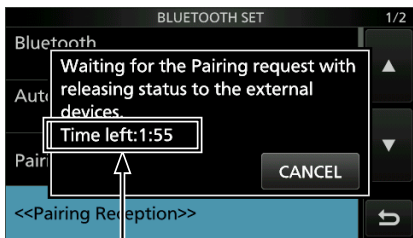

Turn ON Bluetooth with your Android device within the displayed period of time. When the time runs out, the transceiver exits the Pairing Reception mode.

Step 2. Turning ON Bluetooth (Android device)

Turn ON Bluetooth with your Android device.

- The Android device displays the transceiver Bluetooth unit’s name.
- ① You can confirm the transceiver Bluetooth unit’s name on the BLUETOOTH DEVICE INFORMATION screen. (Default: ICOM BT(IC-705)) (p. 10-7)
 - ① See the instruction manual of the Android device for details.

Step 3. Sending a pairing request to the transceiver (Android device)

Select the displayed transceiver Bluetooth unit’s name to send a pairing request to.

- The Android device starts to send a pairing request.
- The Android device displays “To pair with: ICOM BT(IC-705). Make sure it is showing this passkey: * * * * *.”

Step 4. Receiving a pairing request (Transceiver)

1. When the transceiver receives a pairing request, confirm the displayed passkey is the same as yours, and then, touch [CONFIRM].

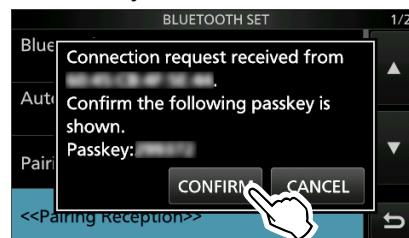

- Pairing starts.

2. Touch “Pairing/Connect.”

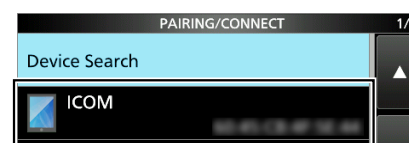
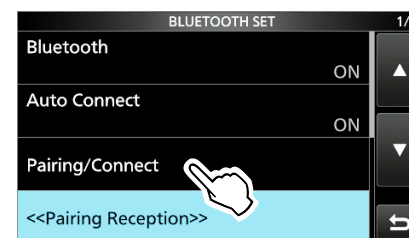

After the pairing is complete, the Android device name is displayed on the pairing list.

NOTE: When you pair with a third party’s data device, entering a PIN code or passkey may be required. See the instruction manual of the data device for details on how to enter a PIN code or passkey.

Disconnecting a Bluetooth® device from the transceiver

There are 3 ways to disconnect a Bluetooth device (headset device or data device).

- Turn OFF a device.
- Turn OFF the Bluetooth function on a device.

① See the instruction manual of the headset or a data device for details.

Or, you can disconnect a Bluetooth device without canceling the pairing, as described below.

1. Open the PAIRING/CONNECT screen.

MENU » **SET > Bluetooth Set > Pairing/Connect**

2. Touch the Bluetooth device.

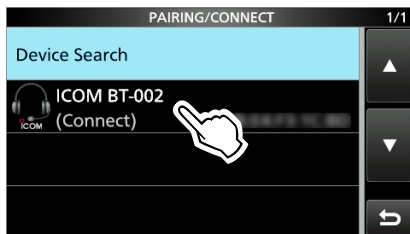

- The confirmation dialog “Disconnect?” is displayed.

3. Touch [YES].

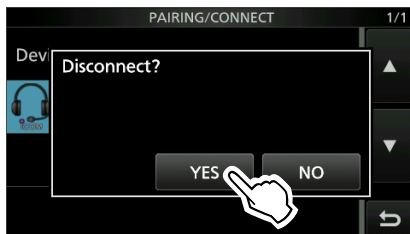

- The transceiver disconnects from the Bluetooth device, and “(Connect)” disappears from the list. However, the transceiver is still paired with the device.

① When you touch the unconnected device displayed in the pairing list, the transceiver displays “Connect?.” To connect to the device, touch [YES].

Deleting a Bluetooth® device from the pairing list

You can delete a Bluetooth device from the pairing list.

Before deleting a connected Bluetooth device, disconnect it.

1. Open the PAIRING/CONNECT screen.

MENU » **SET > Bluetooth Set > Pairing/Connect**

2. Touch the Bluetooth device for 1 second.

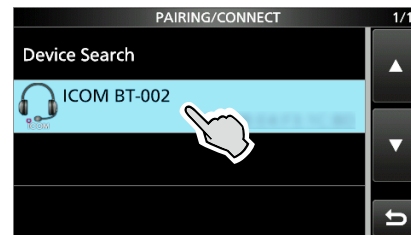

3. Touch “Delete.”

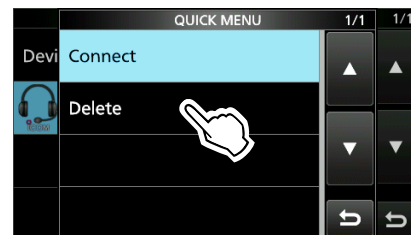

- The confirmation dialog “Delete?” is displayed.

4. Touch [YES].

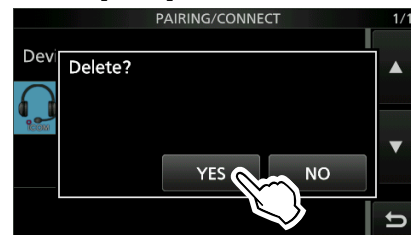

- Deletes the selected device from the pairing list.

TIP: To connect to a deleted device, you must first pair with it again.

- Pairing with a headset: p. 10-2
- Pairing with an Android device: p. 10-5

10. Bluetooth® OPERATION

Editing the Bluetooth® unit name

You can edit the transceiver Bluetooth unit's name.

①After initializing the unit, the edited name remains.

1. Open the BLUETOOTH SET screen.

MENU » **SET > Bluetooth Set**

2. Touch "Bluetooth Device Information."

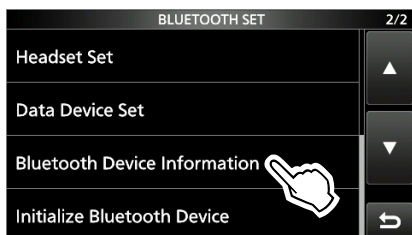

3. Push **QUICK**.

4. Touch "Edit Name."

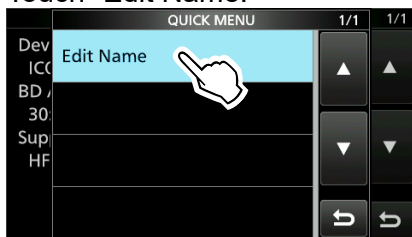

5. Enter a name of up to 9 characters*, and then touch [ENT]. (Example: ICOM BT(IC-705)A)

*After "ICOM BT."

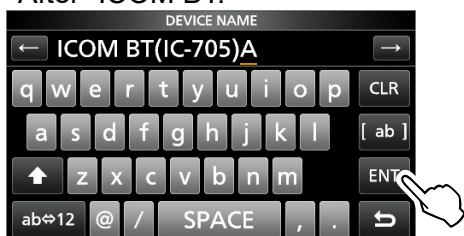

6. To close the BLUETOOTH DEVICE INFORMATION screen, push **EXIT** several times.

Initializing the Bluetooth® unit

You can initialize the transceiver's Bluetooth unit. You should initialize the unit if you have trouble during Bluetooth operation.

①After initializing the unit, the pairing/connect list is deleted, but the Bluetooth settings and the unit name remain.

The Bluetooth settings return to their factory defaults only when you do a partial reset or all reset. (Basic manual)

1. Open the BLUETOOTH SET screen.

MENU » **SET > Bluetooth Set**

2. Touch "Initialize Bluetooth Device."

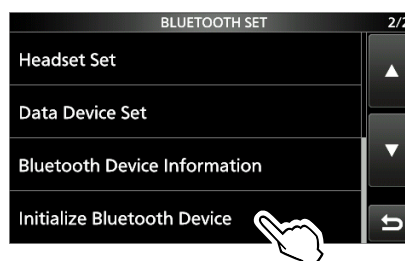

3. Touch [YES].

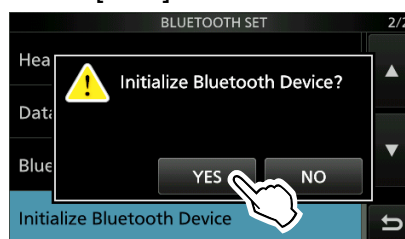

- The transceiver will automatically restart.

The maximum number of paired devices

You can pair 2 types of the Bluetooth devices: a Headset and Data device.

Up to 5 Bluetooth devices can be paired with the transceiver. However, you cannot pair with more than 4 headsets only or more than 4 data devices only.

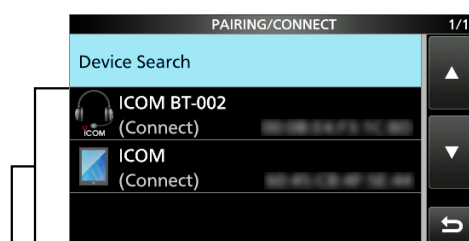

→ Displays the paired Bluetooth device.

11. WIRELESS LAN OPERATION

Wireless LAN operation

You can use the Wireless LAN (WLAN) function for:

- Synchronizing the internal clock with a time management server. (p. 9-4)
- Outputting the demodulated AF signal or 12 kHz IF signal.
 - ① You can select the output signal from AF and IF signals.
MENU » **SET > Connectors > WLAN AF/IF Output**
- Remotely controlling using the optional RS-BA1 software application.
- Gateway communication using the Internal Gateway function. (p. 15-10)
- Transferring pictures from a PC or a mobile device.

Turning ON the Wireless LAN function

1. Open the WLAN SET screen.

MENU » **SET > WLAN Set**

2. Touch "WLAN."

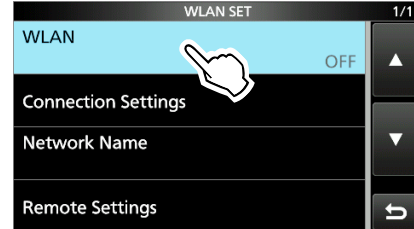

3. Touch "ON."

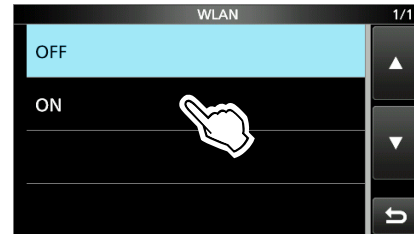

4. To close the WLAN SET screen, push **EXIT** several times.

Connecting to a Wireless Access Point (AP)

- Open the ACCESS POINT screen.
[MENU] » SET > WLAN Set > Connection Settings > **Access Point**

- Touch a wireless access point (AP).
 (Example: WIRELESSLAN)

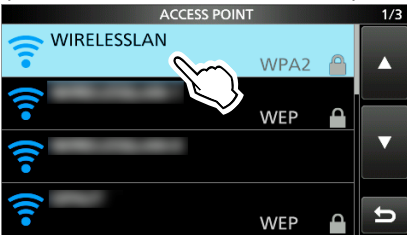

- Touch "Password."



- Enter the password, and then touch [ENT].
 (Example: password)

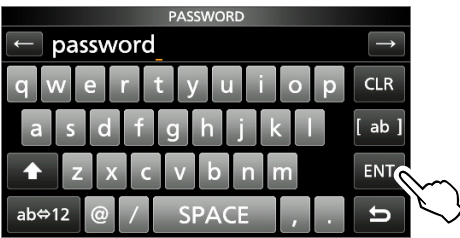

- Touch "<<Connect>>."

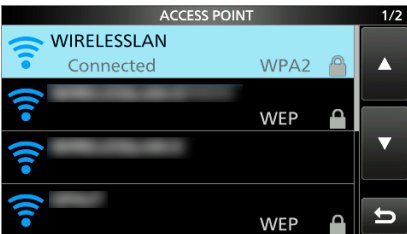
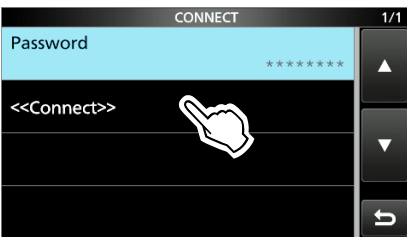

- Connects to the AP.
 - While connected to the AP, "Connected" is displayed in the ACCESS POINT list.
- ① If the connection fails, returns to the CONNECT screen.

- To close the ACCESS POINT screen, push **[EXIT]** several times.

① While connected to a wireless network, the wireless LAN icon is displayed.

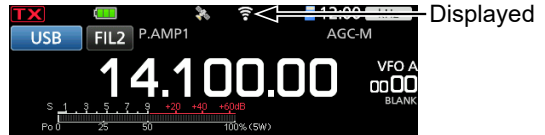

① The transceiver automatically connects to the last connected AP when the transceiver is turned ON.

NOTE:

- The transceiver cannot connect to a 5 GHz wireless network.
- Up to 7 access points that the transceiver has connected to before are saved. When you connect to the 8th AP, the oldest AP is deleted.
- It may take a longer time to turn OFF the transceiver while connected to the AP, depending on your network environment.

TIP:

Search again for an Access Point device

When the transceiver cannot find an AP that you want to connect to, push **[QUICK]**, and then touch "Re-search" to search again.

Manually connect to an Access Point device

- Open the MANUAL CONNECT" screen.
[MENU] » SET > WLAN Set > Connection Settings > **Manual Connect**
- Set "SSID," "Security Type," and "Password."
- Touch "<<Connect>>."

12. GPS OPERATION (ADVANCED)

GPS TX mode and TX format types

GPS position data has 2 TX modes, D-PRS and NMEA. Moreover, with the D-PRS mode data, 5 position formats, Position (Mobile station/Base station), Object, Item, and Weather, are selectable.

Example: When the caller's TX format is D-PRS Position (Mobile)

MENU » GPS > GPS Position

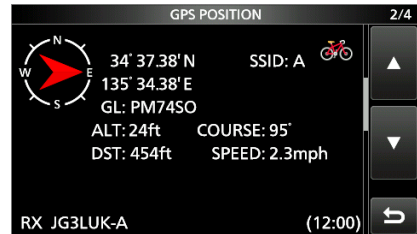

D-PRS	D-PRS is a function that simultaneously sends position data received from the internal GPS receiver, using the slow speed data packet space, along with voice.
Position (Mobile)	A station operating from a vehicle, or other position, away from its normal base position.
Position (Base)	A station operating at home or in a building.
Object	Transmitting Object data such as earthquake information, satellite tracking information, and so on. An Object contains a time stamp.
Item	Transmitting Item data such as a traffic accident, lighthouse, antenna, or DV access point position, and so on. An Item does not contain a time stamp.
Weather	A station transmitting weather information received from a weather device.
NMEA	A station transmitting position data (NMEA0183) received from the internal GPS receiver.

Differences between older models

(As of July 2020)

- The GPS TX mode, “GPS (DV-G)” and “GPS-A (DV-A),” are now called as “NMEA (DV-G)” and “D-PRS (DVA).”
GPS (DV-G) → NMEA (DV-G)
GPS-A (DV-A) → D-PRS (DV-A)
- For users who have one of the following models:
ID-800H, IC-91AD/E91, IC-U82, IC-V82, IC-7100, ID-51A/E, ID-31A/E, IC-9100, IC-80AD/E80D, ID-880H/E880, IC-92AD/E92D, IC-2820H/E2820
When you receive a D-PRS position (Base), Object, Item, or Weather information, their data is not displayed.
- Only the ID-51A/E PLUS, ID-51A/E PLUS2, ID-31A/E PLUS, ID-5100A/E, ID-4100A/E, IC-R30, IC-9700, and IC-705 can receive Power, Height, Gain, and Directivity data.
- For users who have one of the following models:
IC-9100, IC-80AD, IC-E80D, ID-880H, ID-E880, IC-92AD, ICE92D, IC-U82, IC-V82
If you transmit with the Altitude setting ON, the character string is included in a comment on the products that cannot display the altitude.
- Set the GSV sentence to OFF when sending the GPS message to conventional digital transceivers (IC-2820H, IC-E2820, ID-800H, IC- 91AD, IC-E91, IC-V82, IC-U82, IC-2200H). The GSV sentence is incompatible with them.
They will not display GPS messages properly if sent as a GSV sentence from the IC-705.

12. GPS OPERATION (ADVANCED)

When a received signal contains position data

When a received signal contains position data, the caller's position data is displayed in the RX position screen.

See to the right for details.

Example: When the signal from JG3LUK contains position data.



When you receive the signal, the RX position data is displayed in the RX position window.

After a few seconds, the window disappears.



RX position icon

When the received signal contains position data, the RX position icon is displayed, as shown above.

① If you touch the RX position icon, the RX position window is displayed again.

① You can turn OFF the caller's position data display.

MENU » **SET > Display > RX Position Display**

① You can turn OFF the RX position icon indication.

MENU » **SET > Display > RX Position Indicator**

Checking your location

You can check your current location.

This section is described using received position data.

① The screens are just examples.

◇ Displaying Position Data

1. Push **QUICK** in the standby mode.
2. Touch "GPS Position."
 - Opens the GPS POSITION screen.
3. Rotate **MAIN DIAL**.
 - Changes between the MY (My position), RX (Received position), MEM (GPS Memory position), or ALM (GPS Alarm position) screen.



The displayed icon depends on the type of screen (MY, RX, MEM, or ALM).

4. To close the GPS POSITION screen, push **EXIT**.

NOTE: Latitude, longitude, and altitude data may differ, depending on your received GPS signal.

TIP:

- If you transmit with the GPS POSITION screen open, the screen closes. To check the location, push **QUICK**, and then touch "GPS Position" while transmitting.
- On the MY screen or RX screen, you can enter the displayed position information in a GPS Memory by pushing **QUICK** and touching "GPS Memory."
- See page 12-19 about the GPS Memory function and see page 12-24 about the GPS Alarm function for more details.

12. GPS OPERATION (ADVANCED)

Checking your location

◇ GPS POSITION screens and their meanings

① Information

- Pushing **QUICK** to change the compass direction. (p. 12-6)
- About the Course (p. 12-5)
- About the Grid Locator (p. 12-5)

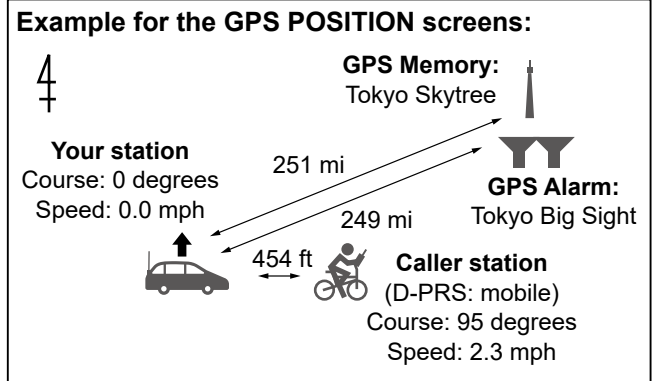

MY screen (Your position information)

When “GPS Select” is set to “Manual,” the compass heading and course direction are not displayed. (p. 12-31)

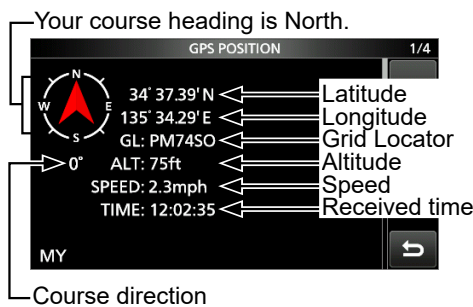

MEM screen (GPS Memory's information)

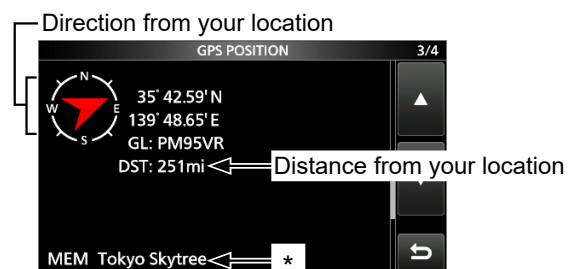

RX screen (Caller's position information)

Depending on the caller's GPS TX Mode and TX format, the displayed item's meanings may differ, and some data may not be displayed. (p. 12-4)

Example: The caller station's GPS TX Mode is “D-PRS,” and its TX format is “Position (Mobile).”

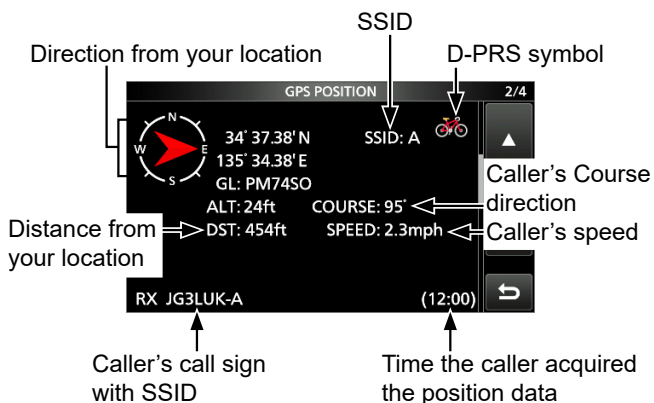

ALM screen (GPS Alarm's information)

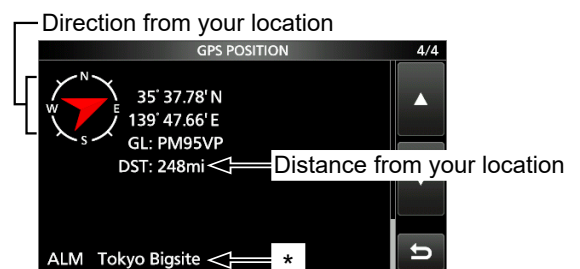

* When a name is not entered in the GPS Memory channel, date and time are displayed instead of the name. In the QUICK MENU screen, you can change the GPS Memory or GPS Alarm in the GPS POSITION screen. (p. 12-5)

12. GPS OPERATION (ADVANCED)

Checking your location

◇ About the RX screen

TX format: D-PRS

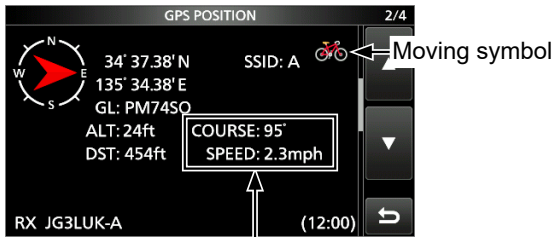

For a mobile station, Course and Speed are displayed.

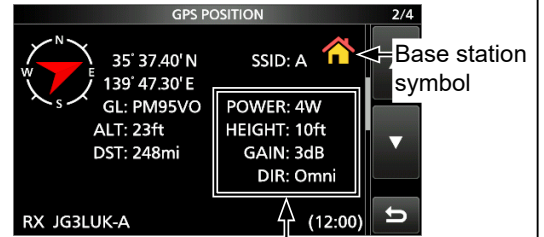

For a base station, Output power, Antenna height, Antenna gain, and Antenna direction are displayed.



Time that the caller sent the Object's data.

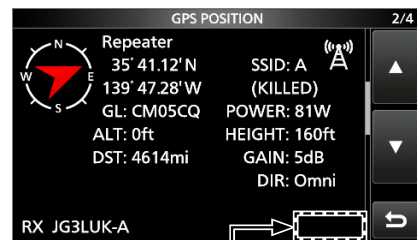

① For an Item station, Time is not displayed.



Time that the caller acquired the weather data.

① Call sign is displayed with an SSID.

① When the Object or Item is disabled, "KILLED" is displayed.

TX format: NMEA

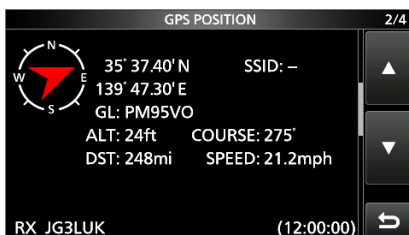

① A symbol or SSID is not displayed when the TX format is NMEA.

12. GPS OPERATION (ADVANCED)

Checking your location

◇ About the Course

The course displayed on the GPS POSITION screens is indicated in degrees.

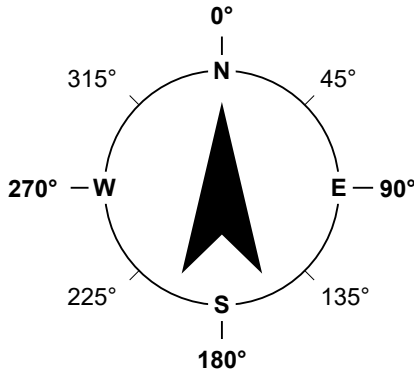

◇ About the Grid Locator

Grid Locator (GL) is a position compressed into a 6 character code, calculated by the longitude and the latitude.

The locator is simply calculated by dividing the earth's surface into squares.

It is used to find the location of a transceiver station.

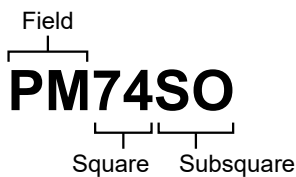
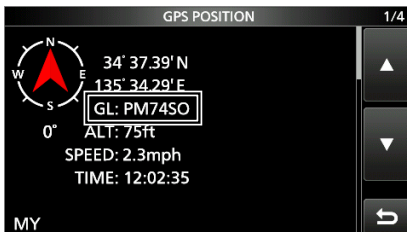

The grid locator map of Japan

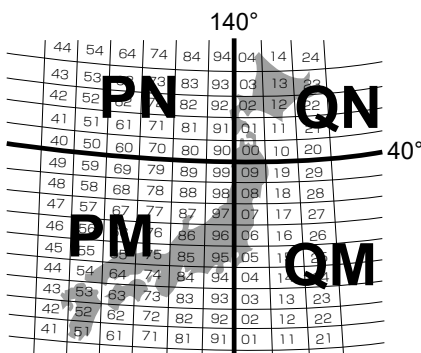

◇ Changing the GPS Memory or Alarm

You can change the GPS Memory or GPS Alarm in the GPS POSITION screen.

1. While selecting the MEM screen or ALM screen, push **QUICK**.
2. Touch "GPS Memory Select," or touch "Alarm Select."

MEM screen

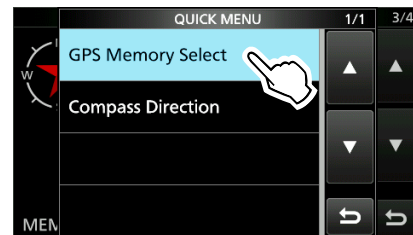

ALM screen



3. Select the GPS Memory or GPS Alarm to display on the GPS POSITION screen.
 - ① Adding or editing a GPS Memory: p. 12-19
 - ① Setting the GPS Alarm: p. 12-24

12. GPS OPERATION (ADVANCED)

Checking your location

◇ Changing the Compass Direction

You can set the compass direction to Heading Up, North Up, or South Up.

1. While displaying the GPS POSITION screen, push **QUICK**.
2. Touch “Compass Direction.”

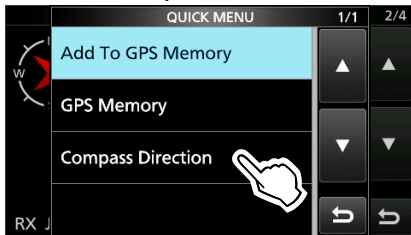

3. Select the compass direction.

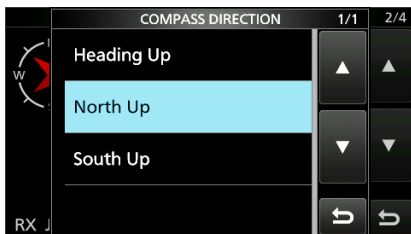

Heading Up



The top is always your course direction.

North Up



The top is always north.

South Up



The top is always south.

◇ Saving your own or a received station's position

You can save the position of your station or the position of the caller station.

The transceiver has a total of 300 GPS memories, and the memories can be assigned into one of 27 banks, A ~ Z, and (No Group).

1. Select the screen that you want to save.
 - ① To save your own position: MY screen
 - ① To save a received position: RX screen
2. Push **QUICK**.
3. Touch “Add To GPS Memory.”

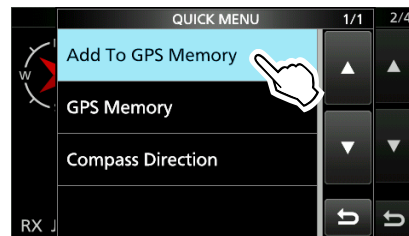

① See pages 12-19 ~ 12-21 for entering details.

4. Touch “<<Add Write>>.”

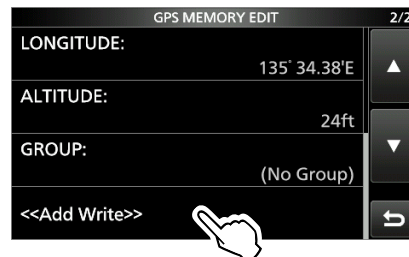

① To select the destination group to be saved, touch “GROUP.”

5. Touch [YES].
 - Saves the data in the GPS Memory, then returns to the GPS POSITION screen.
6. To close the GPS POSITION screen, push **EXIT**.

TIP: The position is saved in the selected group in the GPS MEMORY EDIT screen. (Step 4)

Checking GPS information (Sky view screen)

This screen is used to view GPS satellite information when the GPS icon does not stop blinking for a long time. The GPS Information displays the quantity, signal power, and position of the GPS satellites. The sky view screen displays the position of GPS satellites. The screen also displays each satellite's direction, elevation angle, satellite numbers, and their receiving signal strength status.

1. Push **QUICK**.
2. Touch "GPS Information."

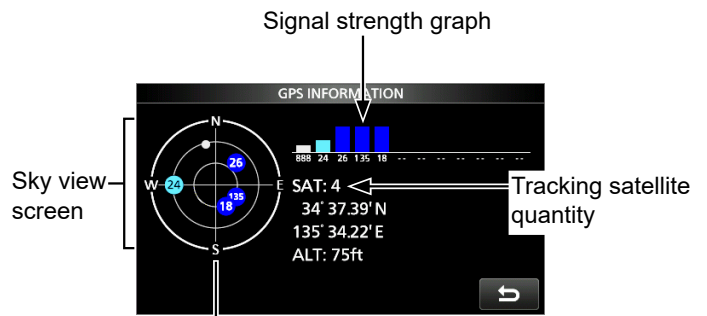
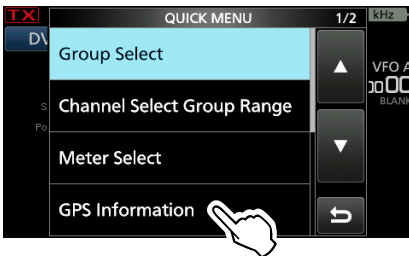

About the display

- : Untracking satellite.
- : Tracking satellite with a weak signal, shown by the satellite number.
- : Tracking satellite with a strong signal, shown by the satellite number.
- SAT: The quantity of tracking satellites.
- Altitude: The altitude of your station. The altitude is only displayed when 4 or more satellites are tracked. When 3 or less satellites are tracked, "-----ft" is displayed.
- Longitude/Latitude: Longitude and Latitude of your station.
- Signal strength graph:
 - Signal strength of the satellites
 - : Untracking satellite
 - : Tracking satellite with a weak signal
 - : Tracking satellite with a strong signal

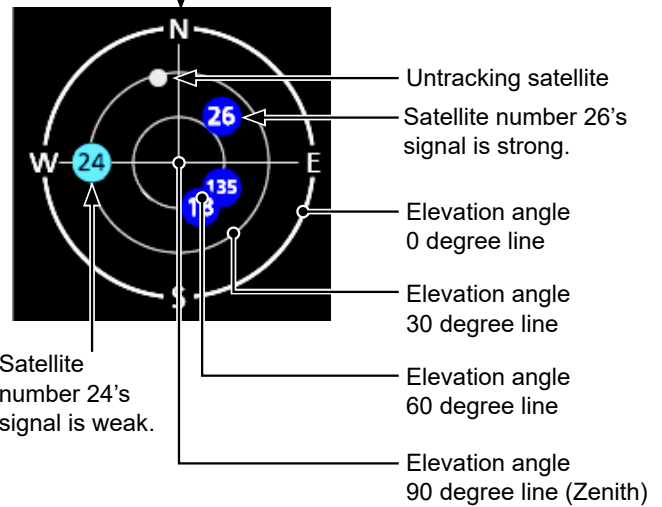

3. To close the GPS INFORMATION screen, push **EXIT**.

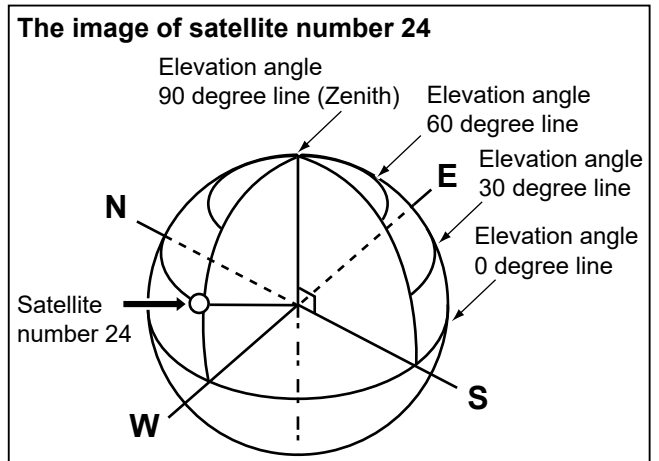

Transmitting D-PRS data

When D-PRS is selected as the GPS TX mode, you can transmit D-PRS data.

When operating in the D-PRS mode, the following codes are transmitted to the PC.

D-PRS code is based on APRS® code.

(APRS®: Automatic Packet Reporting System)

◇ D-PRS

D-STAR Packet Reporting System (D-PRS) is a mode that simultaneously sends position data received from the internal GPS receiver, using the slow speed data packet space, along with voice audio in the DV mode. In the Analog mode, you can transmit or receive only voice audio or data at one time. However, a D-PRS capable radio can transmit or receive message data or GPS position data at the same time voice is being transmitted or received. An I-GATE is required to send position data to the APRS server.

NOTE:

- If “GPS select” is set to “Manual,” the manually entered position data in “Manual Position” is changed to the D-PRS data format to transmit.

MENU » **GPS > GPS Set > GPS Select**

- Note that if “GPS Auto TX” is set to any other setting than “OFF,” the data is transmitted according to the set time.

MENU » **GPS > GPS Auto TX**

The image of D-PRS

<Using a Repeater>

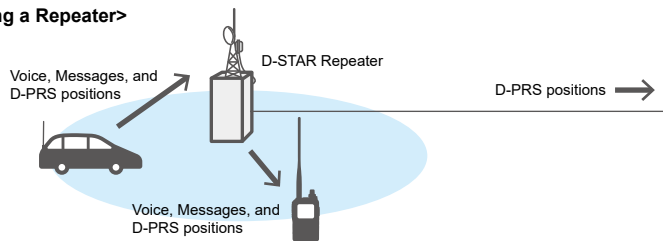

<Simplex>

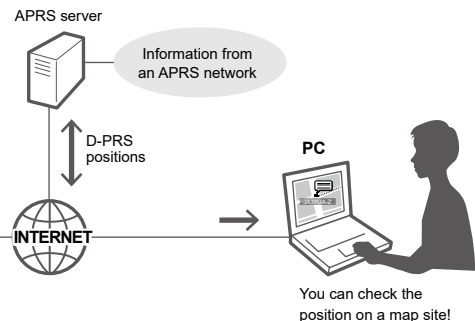
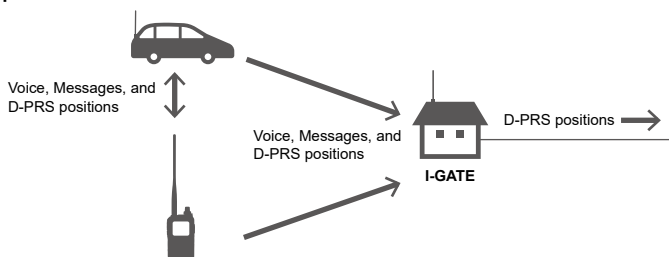

◇ Operating in the D-PRS mode

To transmit D-PRS data, follow the steps below. For more details, see the pages listed along with the steps.

1. Enter “MY” (Your own call sign). (p. 13-3)
2. Confirm the GPS signal receiving.
3. Set GPS TX mode to “D-PRS.” (p. 12-32)
4. Set TX information.

① You must set “SSID” and “Symbol.”

MENU » **GPS > GPS TX Mode > D-PRS**



Complete! You can transmit in the D-PRS mode.

TIP: In the D-PRS mode, you can transmit earthquake or weather information, in addition to position data.

MENU » **GPS > GPS TX Mode > D-PRS > TX Format**

TX format of D-PRS

- Position (Mobile/Base): Used to transmit position data.
- Object: Used to transmit specific position data. (Contains a time stamp.)
- Item: Used to transmit specific position data. (Does not contain a time stamp.)
- Weather: Used to transmit weather information.

12. GPS OPERATION (ADVANCED)

Transmitting D-PRS data

◇ Displayed items

Depending on the TX format, the setting items and displayed order of the items differ.

	D-PRS								
	Position		Object			Item			Weather
	Mobile	Base	Data extension: OFF	Data extension: Course/Speed	Data extension: Power/Height/Gain/Directivity	Data extension: OFF	Data extension: Course/Speed	Data extension: Power/Height/Gain/Directivity	
Unproto Address	✓	✓	✓	✓	✓	✓	✓	✓	
Comment	✓	✓	✓	✓	✓	✓	✓	✓	✓
Altitude	✓	✓							
Object Name/ Item Name			✓	✓	✓	✓	✓	✓	
Data Type			✓	✓	✓	✓	✓	✓	
Position information (Latitude/Longitude/ Altitude)			✓	✓	✓	✓	✓	✓	
Data Extension	✓	✓	✓	✓	✓	✓	✓	✓	
Course				✓			✓		
Speed				✓			✓		
Power		✓			✓			✓	
Height		✓			✓			✓	
Gain		✓			✓			✓	
Directivity		✓			✓			✓	
Symbol	✓	✓	✓	✓	✓	✓	✓	✓	✓
SSID	✓	✓	✓	✓	✓	✓	✓	✓	✓
Time stamp	✓	✓	✓	✓	✓				✓

✓: Displayed

12. GPS OPERATION (ADVANCED)

Transmitting D-PRS data

◇ Setting D-PRS Position (Mobile/Base)

Set to transmit as a D-PRS Position (Mobile/Base).

① See page 12-32 for details.

1. Setting the GPS TX Mode to D-PRS

MENU » **GPS > GPS TX Mode > D-PRS**

2. Checking the Unproto Address

You should use the default address, and editing is not recommended.

3. Setting the TX format to “Position”

Set “TX Format” to “Position.”

4. Selecting the Symbol

Select the Symbol that indicates your operating situation.

① See page 12-32 to directly enter the Symbol.

5. Selecting the SSID

To assist in identifying your station’s type, select the APRS® (Automatic Packet Reporting System) based SSID after the D-PRS data call sign. (p. 12-33)

6. Entering a comment

Enter a comment, and transmit it with the D-PRS position data.

① The number of characters you can enter differs, depending on the data extension and altitude settings. (p. 12-33)

1. Touch “Comment.”
2. Push **QUICK**.
3. Touch “Edit.”
4. Enter a comment.
5. After entering, touch [ENT].
6. Push **EXIT**.

7. Setting the Time Stamp

Set the Time Stamp function to transmit the received time data in UTC (Universal Time Coordinated) time. (p. 12-33)

8. Setting the Altitude

Set whether or not to transmit the altitude data acquired from the GPS receiver. (p. 12-34)

NOTE: If you transmit with the altitude setting ON, the character string is included in a comment on the products that cannot display the altitude. (p. 12-33)

9. Setting the Data Extension

Set the data extension of your station’s information.

- ① Set “Data Extension” to “Course/Speed” to transmit as a mobile station.
- ① Set “Data Extension” to “Power/Height/Gain/Directivity” to transmit as a base station.

When you set “Data Extension” to “Power/Height/Gain/Directivity”:

9-1. Setting the TX power

Select the TX power level of the base station, to transmit along with the position data.

9-2. Setting the antenna height

Select the height of the base station’s antenna, to transmit along with the position data.

9-3. Setting the antenna gain

Select the gain of the base station’s antenna, to transmit along with the position data.

9-4. Setting the antenna directivity

Select the direction the base station’s antenna was pointing, to transmit along with the position data.

10. Exiting the POSITION screen

To close the POSITION screen, push **EXIT** several times.

- Returns to the standby screen, and then **DV** is displayed.

12. GPS OPERATION (ADVANCED)

Transmitting D-PRS data

◇ Setting D-PRS Object/Item

Set to transmit as a D-PRS Object or Item.

① See page 12-35 for details.

1. Setting the GPS TX Mode to D-PRS

MENU » **GPS > GPS TX Mode > D-PRS**

2. Checking the Unproto Address

You should use the default address, and editing is not recommended.

3. Setting the TX format to “Object” or “Item”

Set “TX Format” to “Object” or “Item.”

4. Entering Object name or Item name

Enter an Object or Item name, such as an event information or location.

5. Setting Data type

Set the Object or Item’s status.

① For example, if you want to transmit finished event information as an Object, set the Date type to “Killed Object.”

6. Setting the Symbol

Select the Symbol that indicates an Object or Item.

① See page 12-32 to directly enter the Symbol.

7. Entering a comment

Enter a comment to transmit as an Object or Item.

① The number of characters you can enter differs, depending on the data extension and altitude settings. (p. 12-35)

1. Touch “Comment.”
2. Push **QUICK**.
3. Touch “Edit.”
4. Enter a comment.
5. After entering, touch [ENT].
6. Push **EXIT**.

8. Entering the Position data

Enter the position data of an Object or Item.

① For example, if you want to transmit traffic accident information as an Item, enter the position data where the accident happened.

If the position data is in the GPS memory, you can easily set the position data from the memory.

9. Setting the Data Extension

Set the data extension of an Object or Item’s information.

- ① Set “Data Extension” to “Course/Speed” to transmit as a mobile station.
- ① Set “Data Extension” to “Power/Height/Gain/Directivity” to transmit as a base station.

When you set “Data Extension” to “Course/Speed”:

9-1. Entering the Course

Enter the Object or Item’s course when the station moves.

9-2. Entering the Speed

Enter the Object or Item’s speed.

When you set “Data Extension” to “Power/Height/Gain/Directivity”:

9-3. Selecting the TX power

Select the TX power level of the Object or Item if the station is a repeater, node, access point, and so on, and an antenna is installed.

9-4. Selecting the antenna height

Select the height of the Object or Item’s antenna.

9-5. Selecting the antenna gain

Select the gain of the Object or Item antenna.

9-6. Selecting the antenna direction

Select the direction the base Object or Item’s antenna is pointing.

12. GPS OPERATION (ADVANCED)

Transmitting D-PRS data

◇ Setting D-PRS Object/Item

10. Selecting the SSID

To assist in identifying your station's type, select the APRS® (Automatic Packet Reporting System) based SSID after the D-PRS data call sign. (p. 12-33)

11. Setting the Time Stamp

① This item is displayed when the TX format is "Object."

Set the Time Stamp function to transmit the received time data in UTC (Universal Time Coordinated) time. (p. 12-36)

12. Exiting the OBJECT or ITEM screen

To close the OBJECT or ITEM screen, push **EXIT** several times.

- Returns to the standby screen, then **DV ↗** is displayed.

◇ **Setting D-PRS Weather**

Set to transmit as a D-PRS Weather station.

① See page 12-39 for details.

1. Setting the GPS TX Mode to D-PRS

MENU » **GPS > GPS TX Mode > D-PRS**

2. Checking the Unproto Address

You should use the default address, and editing is not recommended.

3. Setting the TX format to "Weather"

Set "TX Format" to "Weather."

4. Setting the Symbol

Select the Symbol that indicates the weather station.

① See page 12-32 to directly enter the Symbol.

5. Selecting the SSID

To assist in identifying your station's type, select the APRS® (Automatic Packet Reporting System) based SSID after the D-PRS data call sign. (p. 12-33)

6. Entering a comment

Enter a comment to transmit as a D-PRS Weather station.

1. Touch "Comment."
2. Push **QUICK**.
3. Touch "Edit."
4. Enter a comment.
5. After entering, touch [ENT].
6. Push **EXIT**.

7. Setting the Time Stamp

Set the Time Stamp function to transmit the received time data in UTC (Universal Time Coordinated) time. (p. 12-39)

8. Exiting the WEATHER screen

To close the WEATHER screen, push **EXIT** several times.

- Returns to the standby screen, then **DV ↗** is displayed.

12. GPS OPERATION (ADVANCED)

Transmitting D-PRS data

◇ Weather station transmission

When you transmit as a weather station, you should set the weather station's settings, and input the weather data into the [microUSB] port. You can input the weather data from a third party's weather device by converting it to the APRS weather format in your PC or microcomputer.

After completing the weather station's settings, and inputting the weather data, you can transmit as a weather station.

NOTE: To input the Weather data into the [microUSB] port, set "USB (B) Function" to "Weather."

MENU » SET > Connectors > USB (B) Function > **USB (B) Function**

If the weather data is not input into the [microUSB] port, you cannot transmit as a weather station.

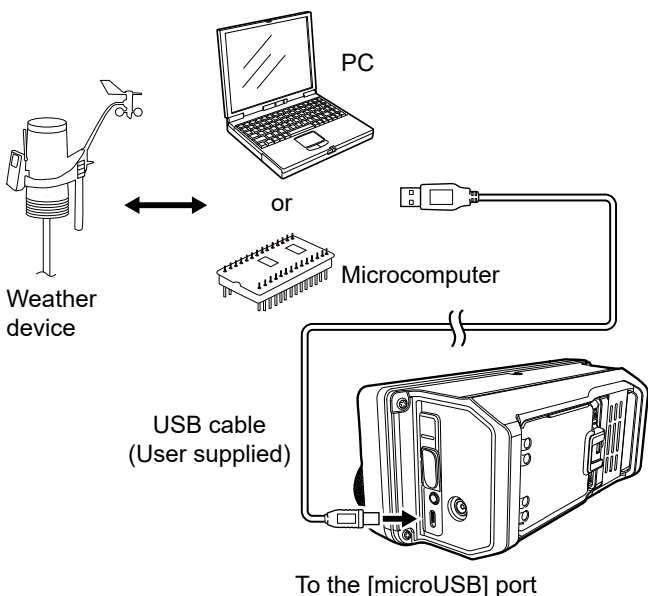

◇ Confirming the weather data input

You can confirm whether or not the weather data is input into the [microUSB] port.

1. Set "GPS TX Mode" to "D-PRS," and "TX format" to "Weather." (p. 12-32)
2. On the standby screen, push **QUICK**.
3. Touch "Weather Information."
 - Displays the WEATHER INFORMATION screen as shown below, if the weather data is input into the [microUSB] port.
 - ① When the weather information is displayed, you can transmit as a weather station. If "-" is displayed on the screen, the weather data is not input into the [microUSB] port. In that case, check the input data settings.

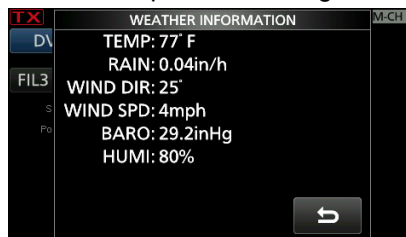

◇ Application setting

Configure the communication software as follows.

- Port: The COM port number that is used by the IC-705.*
- Baud rate: Your desired speed
- Data: 8 bit
- Parity: none
- Start: 1 bit
- Stop: 1 bit
- Flow control: none

* Depending on the PC environment, the COM port number used by the IC-705 may be higher than 5. In that case, use an application that can set it to higher than 5.

12. GPS OPERATION (ADVANCED)

Transmitting D-PRS data

◇ About the weather data content

The weather data should be input according to the format (based on the APRS® Weather Data), shown below.

Example:

220/004 g005 t077 r000 p000 P000 h50 b09900 End code
 1 2 3 4 5 6 7 8 9

No.	Item	Value	Unit
1	Wind direction	000 to 360	°
2	Wind speed	000 to 999	mph
3	Gust speed	g000 to g999	mph
4	Temperature	t-99 to t-01, t000 to t999	°F
5	Rainfall	r000 to r999* ¹	inch
6	Rainfall (24 Hours)	p000 to p999* ¹	inch
7	Rainfall (Midnight)	P000 to P999* ¹	inch
8	Humidity	h00, h01 to h99 (h00 indicates 100%.)	%
9	Barometric pressure	b00000 to b99999* ²	hPa, mb

*¹ The last two digits indicate the one decimal place and the two decimal place.

*² The last digit indicates the one decimal place.

① If you have no data, enter a space or "." (period) instead of a number.

(Example: ".../...g...t077r000p...P...h50b.....")

① Enter <CR>, <LF>, or <CR><LF> for an end code.

12. GPS OPERATION (ADVANCED)

Transmitting D-PRS data

◇ Displaying your location using mapping software

If you transmit to an I-GATE station, and then enter the call sign information on the Internet map website, the selected symbol is displayed.

You can check it on the Internet!

PC



Smartphone



Example: Check your location on the APRS.fi site.

1. Display a free APRS® related map site on the Internet. (Example: <http://aprs.fi/>)
2. Enter your call sign in the "Track callsign" field.
3. Click <Search>.
 - The icon (D-PRS symbol) is displayed on the map site.

Enter your call sign, and then click <Search>.

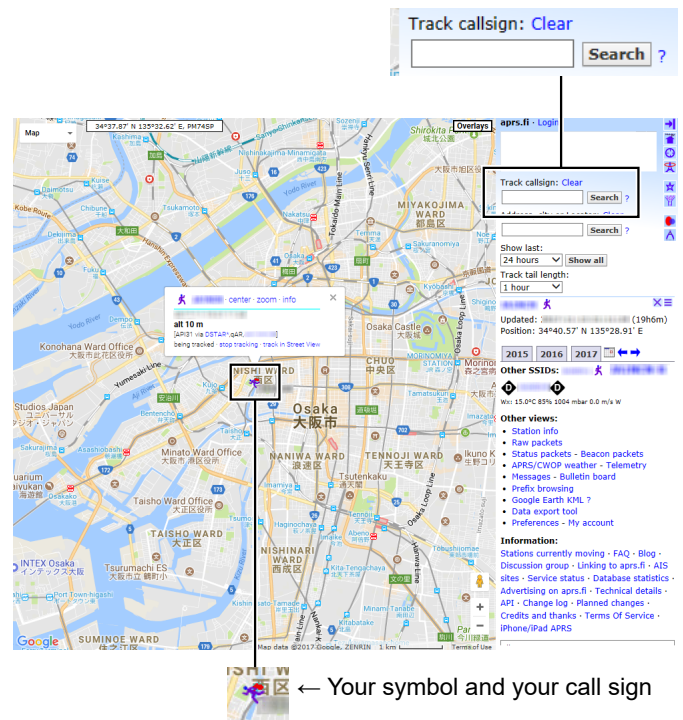

The screenshot shows the APRS.fi website interface. At the top, there is a search bar labeled "Track callsign: Clear" with a "Search ?" button. Below the search bar, a map of Osaka, Japan, is displayed. A red location pin is placed on the map, and a small window above it shows the call sign "J2R1" and the text "all 10 m APRS via DSTAR over being tracked stop tracking track in Street View". To the right of the map, there are various controls and information, including "Show last: 24 hours", "Track tail length: 1 hour", and a list of "Other SSIDs". At the bottom of the map, there is a legend for the "J2R1" call sign, with an arrow pointing to it and the text "← Your symbol and your call sign".

12. GPS OPERATION (ADVANCED)

Transmitting D-PRS data

TIP:

D-PRS data content

D-PRS data content are shown below.

◇Position (Mobile)

(e.g.) JA3YUA-A>API705,DSTAR*:/002338h3437.38N/13534.29E>090/002/A=000012IC-705 OP.SATOH
 ① ② ③ ④ ⑦ ⑧ ⑨ ⑩ ⑨ ⑪ ⑬ ⑭

◇Position (Base)

(e.g.) JA3YUA-A>API705,DSTAR*:/002338h3437.38N/13534.29E-PHG5132OP.SATOH
 ① ② ③ ④ ⑦ ⑧ ⑨ ⑩ ⑨ ⑫ ⑭

◇Object

(e.g.) JA3YUA-A>API705,DSTAR*:/HAM FESTA*012345z3437.38N/13534.29Eh2020.01.01 am10-pm4
 ① ② ③ ④ ⑤ ⑥ ⑦ ⑧ ⑨ ⑩ ⑨ ⑭

◇Item

(e.g.) JA3YUA-A>API705,DSTAR*:/REPEATER!3454.00N/13536.00ErPHG5132439.39MHZ DV RPT JP3YHH A
 ① ② ③ ④ ⑤ ⑥ ⑧ ⑨ ⑩ ⑨ ⑫ ⑭

◇Weather

(e.g.) JA3YUA-A>API705,DSTAR*:/012345z3454.00N/13536.00E 220/004g005t077r000p000P000h50b09900
 ① ② ③ ④ ⑦ ⑧ ⑨ ⑩ ⑨ ⑮ ⑯ ⑰ ⑱ ⑲ ⑳ ㉑ ㉒

① Call sign

② SSID

③ Unproto Address

④ D-PRS Data type

/ Position with time stamp

! Position without time stamp

; Object

) Item

⑤ Object Name/Item Name

⑥ Data Type

* Live Object

! Live Item

_ Killed Object/Killed Item

⑦ Time Stamp (UTC)

h Hour Minute Second

z Day Hour Minute

⑧ Latitude

⑨ Symbol

⑩ Longitude

⑪ Data Extension (Course/Speed)

Course:0 ~ 360°

Speed:0 ~ 999 knots

⑫ Data Extension(PHG codes)

PHG codes definitions

	0	1	2	3	4	5	6	7	8	9	
First: Power	0	1	4	9	16	25	36	49	64	81	(W)
Second: Height	10	20	40	80	160	320	640	1280	2560	5120	(feet)
Third: Gain	0	1	2	3	4	5	6	7	8	9	(dB)
Fourth: Directivity	omni	45°NE	90°E	135°SE	180°S	225°SW	270°W	315°NW	360°N	-	-

⑬ Altitude

-99999 ~ 999999 feet

⑭ Comment

⑮ Wind direction/Wind speed

Wind direction:0 ~ 360°

Wind speed: 0 ~ 999 mph

⑯ Gust speed

0 ~ 999 mph

⑰ Temperature

-99 ~ 999°F

⑱ Rainfall

0.00 ~ 9.99 inch

⑲ Rainfall (24 Hours)

0.00 ~ 9.99 inch

⑳ Rainfall (Midnight)

0.00 ~ 9.99 inch

㉑ Humidity

1 ~ 99%, 00=100%

㉒ Barometric pressure

0.0 ~ 9999.9 hPa

12. GPS OPERATION (ADVANCED)

Transmitting NMEA data

Set a GPS sentence to transmit GPS data in the DV mode.

◇ Setting the GPS data sentence

1. Open the NMEA SET screen.

MENU » **GPS > GPS TX Mode > NMEA**

2. Touch “GPS Sentence.”

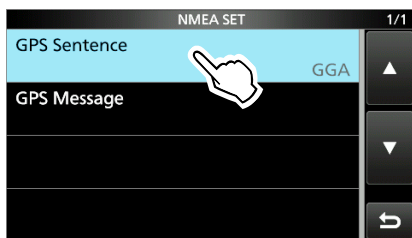

3. Select the GPS sentence.

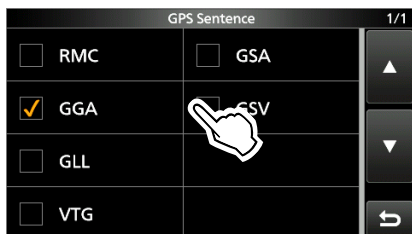

- Displays “✓” when the sentence is set to ON.
- ① The selectable GPS sentences are RMC, GGA, GLL, VTG, GSA, and GSV. The GGA sentence is set to ON as the default GPS sentence.
- ① To reset to the default setting, push **QUICK**, and then touch “Default.”

4. Repeat step 3 to set the GPS sentence.

- ① Up to 4 GPS sentences can be set at a time.

5. To close the “GPS Sentence” screen, push

EXIT several times.

- Returns to the standby screen, then **DV** is displayed.

NOTE:

- Set “GSV Sentence” to “OFF” when sending the GPS message to conventional digital transceivers. (p. 12-1)
- If “GPS Select” is set to “Manual,” the transceiver automatically sets the NMEA sentence, and transmits it along with the manually entered position data in “Manual Position.”

MENU » **GPS > GPS Set > GPS Select**

MENU » **GPS > GPS Set > Manual Position**

- Note that if “GPS Auto TX” is set to any other option than “OFF,” data is automatically transmitted according to the set time.

MENU » **GPS > GPS Auto TX**

- ① If “GPS Select” is set to “OFF” or “Manual,” the GPS Automatic Transmission function is not activated.

Contents of GPS sentence

Sentence	Lon /Lat	Alt	UTC	Date (UTC)	Status	2D /3D	COG (True)	SOG (knot)	Others
RMC	✓		✓	✓	✓		✓	✓	Magnetic variation, Mode Indicator
GGA	✓	✓	✓		✓				Number of satellites in use, HDOP, Geoidal separation, Age of Differential GPS data, Differential reference station ID
GLL	✓		✓		✓				Mode Indicator
VTG							✓	✓	COG (Magnetic north), SOG (km/h), Mode Indicator
GSA					✓	✓			PRN number of satellites used in solution, PDOP, HDOP, VDOP
GSV									Total number of sentences, Sentence number, Total number of satellites in view, Satellite information (ID, Elevation, Azimuth, S/N)

12. GPS OPERATION (ADVANCED)

Transmitting NMEA data

◇ Setting a GPS message

Enter a GPS message to be transmitted with the position data.

Example: Entering “Japan TOM”

1. Open the NMEA SET screen.

MENU » **GPS > GPS TX Mode > NMEA**

2. Touch “GPS Message.”

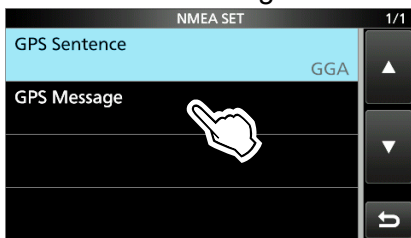

3. Touch [EDIT].

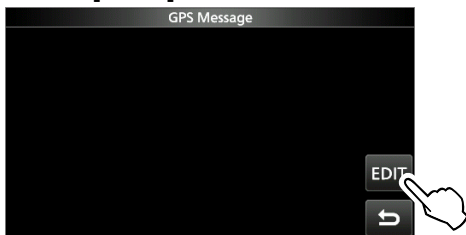

4. Enter a GPS message of up to 20 characters.
5. After entering, touch [ENT].

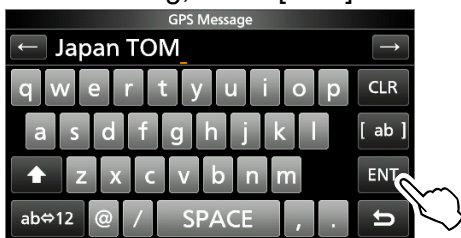

6. To close the “GPS Message” screen, push **EXIT** several times.

GPS Automatic Transmission

NOTE:

- Use the GPS Automatic Transmission function in only the Simplex mode.
- Using the function through a Repeater may interfere with other communications.

You can set the GPS Automatic Transmission function in the following menu.

MENU » **GPS > GPS Auto TX**

If you set this function, GPS data is automatically transmitted according to the set time.

- ① This function is not activated if your call sign (MY) is not entered in the transceiver.
- ① If “GPS Select” is set to “OFF” or “Manual,” this function is not activated.

MENU » **GPS > GPS Set > GPS Select**

GPS Memory

You can add GPS data to GPS Memory. You can add your own position, other station's position, or any positions that are manually entered.

You can save up to 300 GPS memories, and conveniently saved in up to 27 groups, from A ~ Z and "(No Group)." The A to Z groups can also be named.

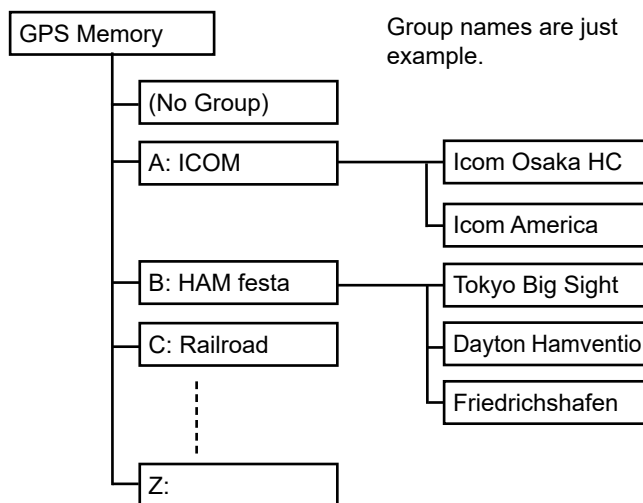

◇ Adding a GPS Memory

Example: Add "HOME" into (No Group).

1. Adding a GPS Memory and entering the edit mode

1. Open the GPS MEMORY screen.

MENU » **GPS > GPS MEMORY**

2. Touch "(No Group)."

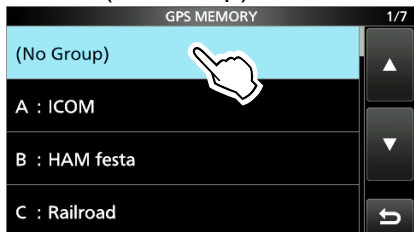

3. Push **QUICK**.

4. Touch "Add."

• Opens the GPS MEMORY EDIT screen.

TIP: To edit the previously saved GPS Memory, touch "Edit" in step 4. You can enter the content in the same way as described above.

2. Entering a GPS Memory name

1. Touch "NAME."

2. Enter a GPS Memory name of up to 16 characters. (Example: HOME)

3. After entering, touch **[ENT]**.

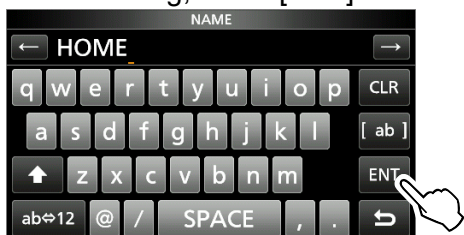

3. Entering the GPS Memory date

1. Touch "DATE."

2. Touch a digit to enter.

3. Touch **[+]** and **[-]**.

① Set to between 2000/01/02 and 2099/12/30.

4. Repeat steps 2 and 3 to enter the date.

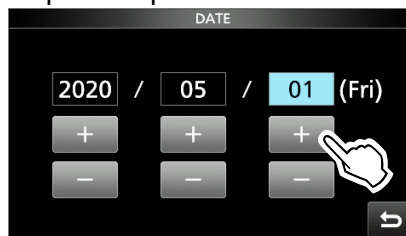

5. After entering, push **EXIT**.

4. Entering the GPS Memory time

1. Touch "TIME."

2. Touch a digit to enter.

3. Touch **[+]** and **[-]**.

① Set to between 00:00:00 and 23:59:59.

4. Repeat steps 2 and 3 to enter the time.

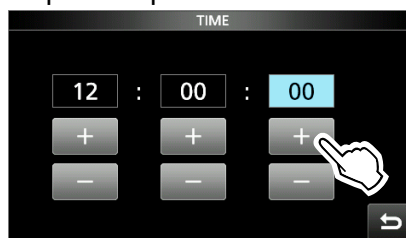

5. After entering, push **EXIT**.

12. GPS OPERATION (ADVANCED)

GPS Memory

◇ Adding a GPS Memory

5. Entering the GPS Memory latitude

1. Touch "LATITUDE."
2. Touch a digit to enter.
3. Enter the latitude.
 - ① Set to between 0°00.00' to 90°00.00'.
 - ① You can change the unit to "ddd°mm'ss'."
4. Repeat steps 2 and 3 to enter the latitude.



5. Touch [N/S] to set to a north latitude (N) or a south latitude (S).
6. After entering, touch [ENT].

6. Entering the GPS Memory longitude

1. Touch "LONGITUDE."
2. Touch a digit to enter.
3. Enter the longitude.
 - ① Set to between 0°00.00' to 180°00.00'.
 - ① You can change the unit to "ddd°mm'ss'."
4. Repeat steps 2 and 3 to enter the latitude.



5. Touch [E/W] to set to an east longitude (E) or a west longitude (W).
6. After entering, touch [ENT].

7. Entering the GPS Memory altitude

1. Touch "ALTITUDE."
2. Touch [+/-] to set to plus or minus.
3. Enter the altitude.



4. After entering, touch [ENT].

8. Selecting a GPS Memory group

1. Touch "GROUP."
2. Touch the group between (No Group) and A ~ Z.

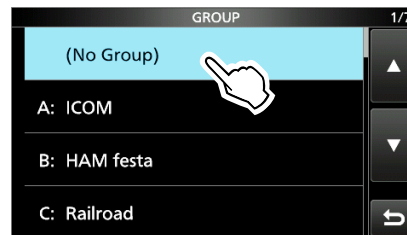

- ① You can save up to 300 Memories in each group.

12. GPS OPERATION (ADVANCED)

GPS Memory

◇ Adding a GPS Memory

9. Writing the GPS Memory

1. Touch “<<Add Write>>.”

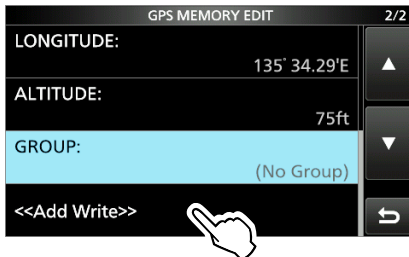

① If you edit a previously added GPS Memory, touch “<<Overwrite>>.”

2. Touch [YES].
 - The data is added to the GPS memory, then returns the selected GPS Memory group screen.
3. To close the GPS Memory group screen, push [EXIT] several times.

TIP:

To view the entered content:

Touch the GPS Memory. Rotate [MAIN DIAL] to check the whole content.

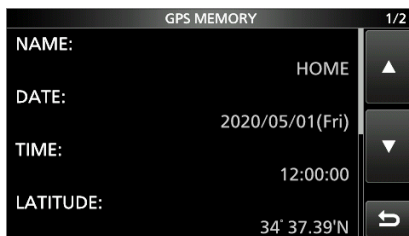

To cancel the entered data:

While entering or editing the GPS Memory, push [EXIT] to display the confirmation dialog. Touch [YES] to cancel entering, then returns to the GPS Memory group screen.

◇ Entering the GPS Memory group name

You can enter a name for each GPS Memory group.

1. Open the GPS MEMORY screen.
[MENU] » [GPS > GPS MEMORY]
2. Touch the group that the name to be entered for 1 second.



3. Touch “Edit Name.”

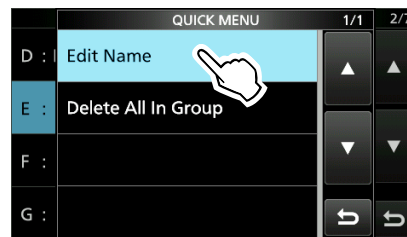

4. Enter a group name of up to 16 characters.
5. After entering, touch [ENT].

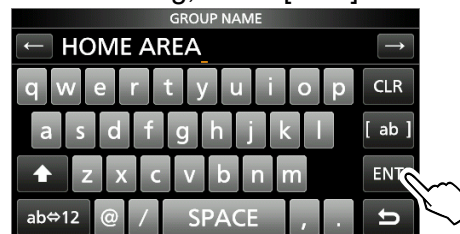

6. To close the GPS MEMORY screen, push [EXIT] several times.

12. GPS OPERATION (ADVANCED)

GPS Memory

◇ Deleting GPS Memory

You can delete the GPS Memories.

There are 2 ways to delete the Memories:

- Deletes all GPS Memory in a group.
- Deletes a specific GPS Memory.

NOTE: Deleted GPS Memories cannot be restored.

Example: Deleting all in Group E.

1. Open the GPS MEMORY screen.

MENU » **GPS > GPS MEMORY**

2. Touch the group where the GPS Memory to delete is saved for 1 second.

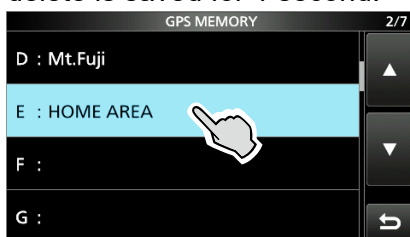

3. Touch "Delete All In Group."

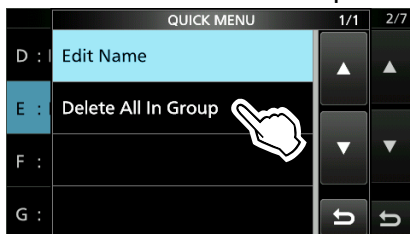

4. Touch [YES].
 - All GPS Memory in the selected group are deleted, then returns to the GPS MEMORY screen.
 - ⓘ When selecting a blank group, "Blank" is displayed.
5. To close the GPS MEMORY screen, push **EXIT** several times.

TIP: Deleting a specific GPS Memory

You can delete a specific GPS Memory.

1. Touch the GPS Memory to delete.
2. Touch "Delete."

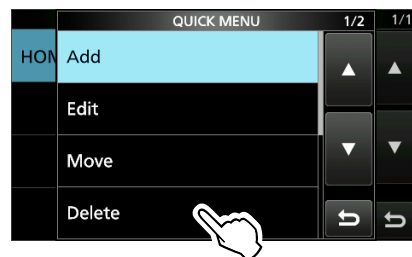

3. Touch [YES].
 - The selected GPS Memory is deleted.

12. GPS OPERATION (ADVANCED)

GPS Memory

◇Rearranging the display order of the GPS data

You can move the entered GPS Memories to rearrange their display order in the selected GPS Memory group.

① To move the GPS Memory out of their assigned Memory group, select the Memory group in the GPS MEMORY EDIT screen, and then save.

1. Open the GPS MEMORY screen.

MENU » **GPS > GPS MEMORY**

2. Touch the group where the GPS Memory you want to move is saved.

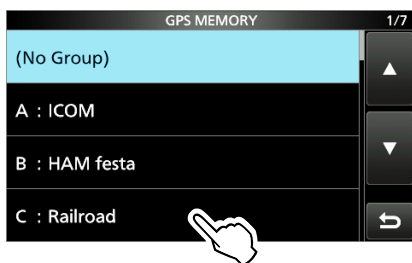

3. Touch the GPS Memory to move for 1 second.



4. Touch "Move."



- While moving, "DESTINATION" blinks.

5. Touch the position to insert the Memory you want to move.

- The selected Memory is inserted above the destination Memory name.

① If you select "<<Move End>>," the Memory is moved to the bottom of the group.

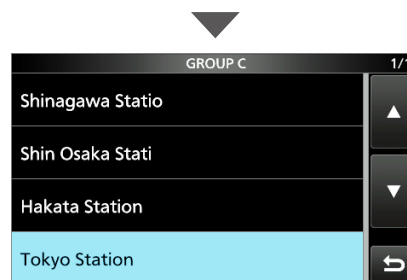

6. To close the GPS MEMORY screen, push **EXIT** several times.

12. GPS OPERATION (ADVANCED)

GPS Alarm

The transceiver can sound a GPS Alarm when a target station or position comes into the alarm area. This function can be set to a caller station, all GPS Memories, a selected GPS Memory group, or a selected GPS Memory.

Alarm Area (Group) (Setting plural stations)

When "All Memories" or a GPS Memory group is selected:

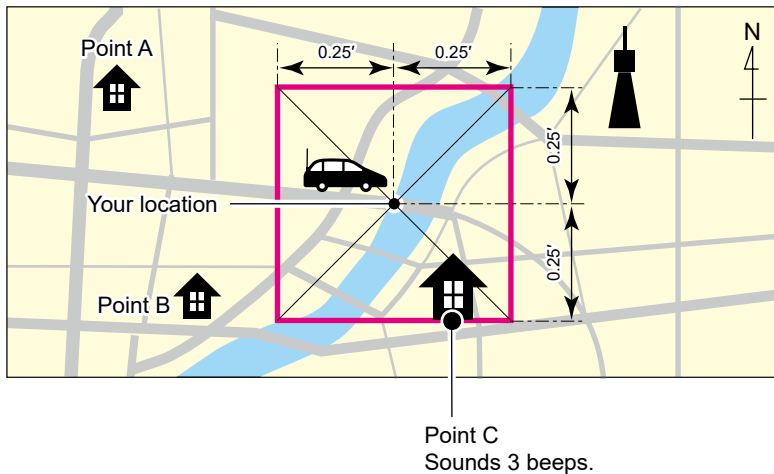

Alarm Area (RX/Memory) (Setting specific station)

When a specific GPS Memory is selected:

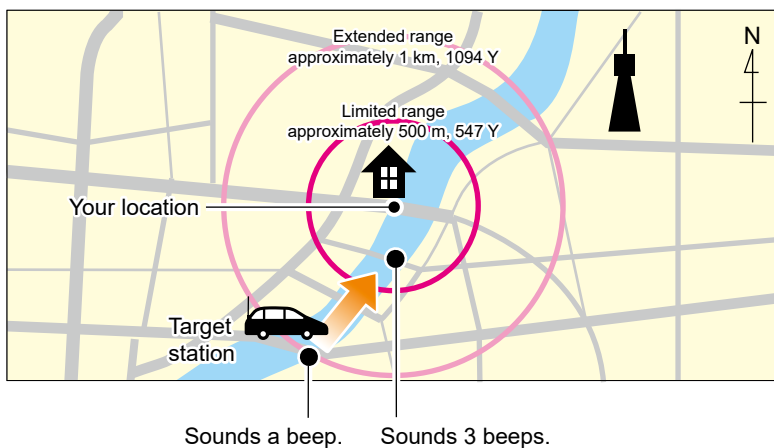

12. GPS OPERATION (ADVANCED)

GPS Alarm

◇ Setting the GPS Alarm function to All Memories (all GPS Memories)

1. Open the GPS ALARM screen.

MENU » **GPS > GPS Alarm**

2. Touch “Alarm Select.”

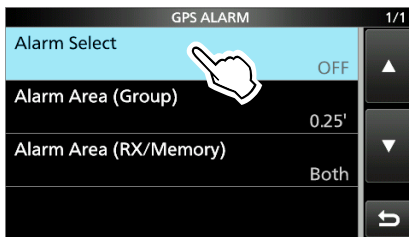

3. Touch “Group.”

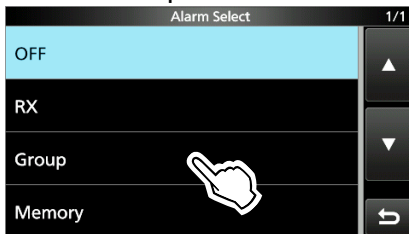

4. Touch “All Memories.”

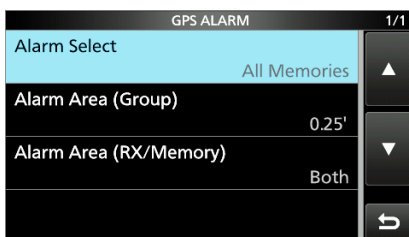
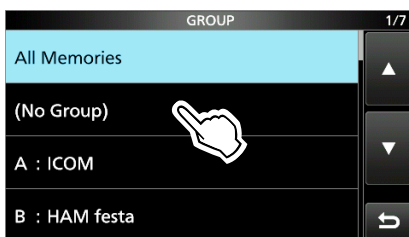

① If you want to set the alarm to a specific GPS Memory group, touch “(No Group)” or “A” to “Z.”

5. To close the GPS ALARM screen, push **EXIT** several times.

① Information

- When either one of the stations in the group enters the set range, the alarm sounds 3 times.
- When the transceiver sounds a GPS Alarm, “GPS ALARM” pops up on the screen, and “” blinks. See the illustration below.
- To cancel the GPS Alarm function, touch “OFF” in step 3 to the left.

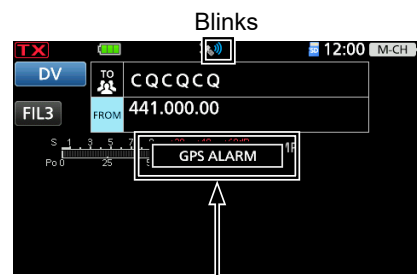

“GPS ALARM” pops up on the screen and the alarm sounds 3 times.

TIP: When selecting “All Memories,” “No Group,” or a GPS Memory group (A ~ Z) in step 4 to the left, you also have to set “Alarm Area (Group)” to use the GPS Alarm function.

MENU » **GPS > GPS Alarm > Alarm Area (Group)**

12. GPS OPERATION (ADVANCED)

GPS Alarm

◇ Setting the GPS Alarm function to RX (a caller station)

1. Open the GPS ALARM screen.

MENU » **GPS > GPS Alarm**

2. Touch “Alarm Select.”

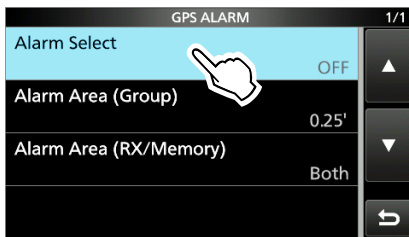

3. Touch “RX.”

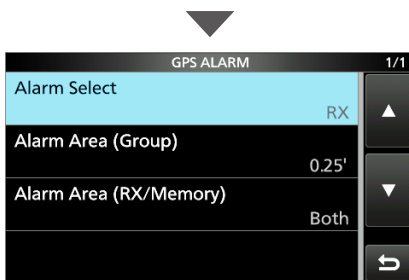
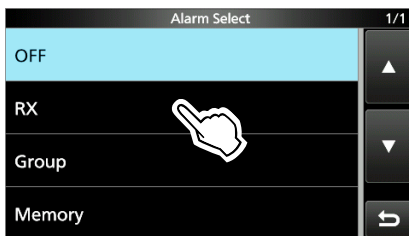

① If you want to set the alarm to a specific GPS Memory, touch “Memory” and then select a GPS Memory in a GPS Memory group.

4. To close the GPS ALARM screen, push **EXIT** several times.

① Information

- When a station with its GPS Alarm set enters within an approximate 1 kilometer (1094 yards) range, the alarm sounds once. When it enters within an approximate 500 meters (547 yards) range, the alarm sounds 3 times.
- When the transceiver sounds a GPS Alarm, “GPS ALARM” pops up on the screen, and “” blinks. See the illustration below.
- To cancel the GPS Alarm function, touch “OFF” in step 3 to the left.



“GPS ALARM” pops up on the screen and the alarm sounds 3 times.

NOTE: Even if “RX” is selected in step 3, when the received signal has no position data, the GPS Alarm does not sound.

TIP: When selecting “RX” or a specific GPS Memory in step 3 to the left, you also have to set “Alarm Area (RX/Memory)” to use the GPS Alarm function.

MENU » **GPS > GPS Alarm > Alarm Area (RX/Memory)**

GPS Logger function

The GPS Logger function enables you to save location data from a GPS receiver onto a microSD card as a log.

The GPS Logger saves Latitude, Longitude, Altitude, Positioning state, Course, Speed, Date, and Time.

If you use this GPS Logger while traveling, you can check your trip history on a mapping software.

NOTE:

- The GPS Logger function requires a microSD card (User supplied).
- Once the GPS Logger function is turned ON, the transceiver continuously saves location data from the GPS receiver, even if the transceiver is turned OFF, then ON again. To cancel this function, turn OFF the function. While this function is ON, and when the transceiver is turned OFF, the log file will be closed. Then the transceiver is turned ON and Positioning is carried out by the GPS receiver, a new log file will be created.
- When the microSD card is full, this function is automatically paused.

◇ GPS Logger operating outline

To use GPS Logger function, perform the following operations.

1. Insert a microSD card*.
* User supplied.
2. Check whether or not the GPS receiver is receiving your location data. (Basic manual)
3. Turn ON the GPS Logger function.



Completed!

You can start using the GPS Logger function.

◇ Confirming the GPS Logger function

Confirm the GPS Logger function is turned ON. When the GPS Logger function is ON, the transceiver saves the location data from the GPS receiver into a microSD card in a set time interval.

① The saved GPS sentences are GGA, RMC, GSA, and VTG.

1. Open the GPS LOGGER screen.

MENU » **GPS > GPS Logger**

2. Confirm “GPS Logger” is set to “ON.”

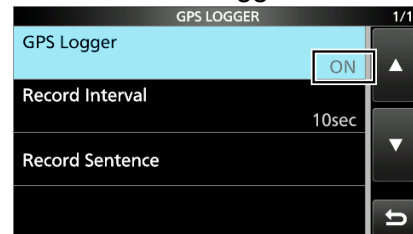

3. To close the GPS LOGGER screen, push **EXIT** several times.

◇ Setting the GPS record interval

For example, when you are walking, and if the time interval is set to “1 sec,” a lot of position data is saved in a short distance. Select the GPS Logger function record interval to suit your travel speed.

1. Open the GPS LOGGER screen.

MENU » **GPS > GPS Logger**

2. Touch “Record Interval.”

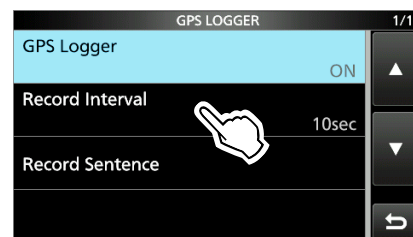

3. Touch the option to set. (Default: 10sec)

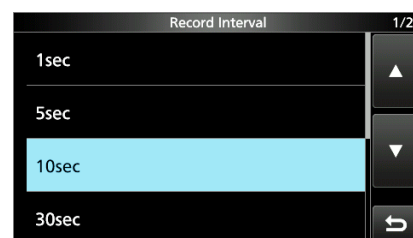

① Select 1, 5, 10, or 30 seconds, or 1, 5, or 10 minutes.

4. To close the GPS LOGGER screen, push **EXIT** several times.

12. GPS OPERATION (ADVANCED)

GPS Logger function

◇ Setting the GPS record sentence

Select the GPS sentence for the GPS Logger function. Select only the required sentences to reduce the data volume.

See the contents table shown below before selecting.

1. Open the GPS LOGGER screen.

MENU » **GPS > GPS Logger**

2. Touch "Record Sentence."

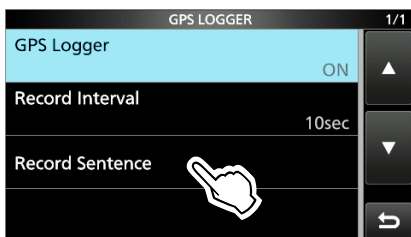

3. Touch the unneeded sentence to remove the checkmark.

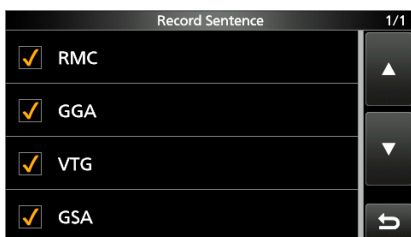

- "✓" disappears when the sentence is set to OFF.

① The selectable GPS sentences are RMC, GGA, VTG, and GSA. All sentences are set to ON as the default.

4. To close the RECORD SENTENCE screen, push **EXIT** several times.

Contents of GPS sentence

Sentence	Lon /Lat	Alt	UTC	Date (UTC)	Status	2D /3D	COG (True)	SOG (knot)	Others
RMC	✓		✓	✓	✓		✓	✓	Mode Indicator
GGA	✓	✓	✓		✓				Number of satellites in use, HDOP, Geoidal separation, Age of Differential GPS data
VTG							✓	✓	COG (Magnetic north), SOG (km/h), Mode Indicator
GSA					✓	✓			ID numbers of satellites used in solution, PDOP, HDOP, VDOP

12. GPS OPERATION (ADVANCED)

GPS Logger function

◇ Viewing the log data on a PC Map

If you want to display your log data, copy the log file to your PC.

① Windows 10 is used for these instructions.

1. Turn OFF the transceiver, then remove the microSD card.
① To remove the card while the transceiver is ON, unmount it first. (See the Basic Manual.)
2. Insert the card into the microSD card drive or a memory card reader* on your PC.
* User supplied.
3. Click the “Open folder to view files” option to access the card.

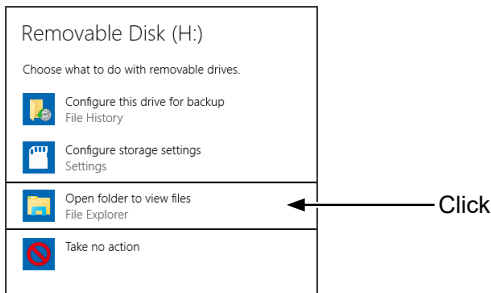

- Displays the “IC-705” folder.

4. Double-click the “IC-705” folder.

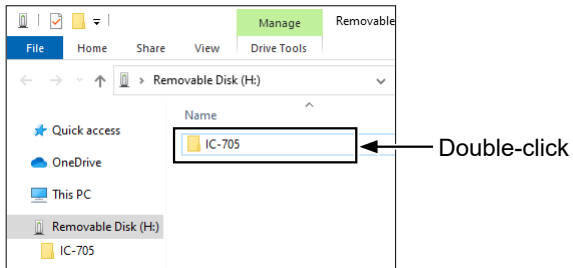

5. Double-click the “Gps” folder.

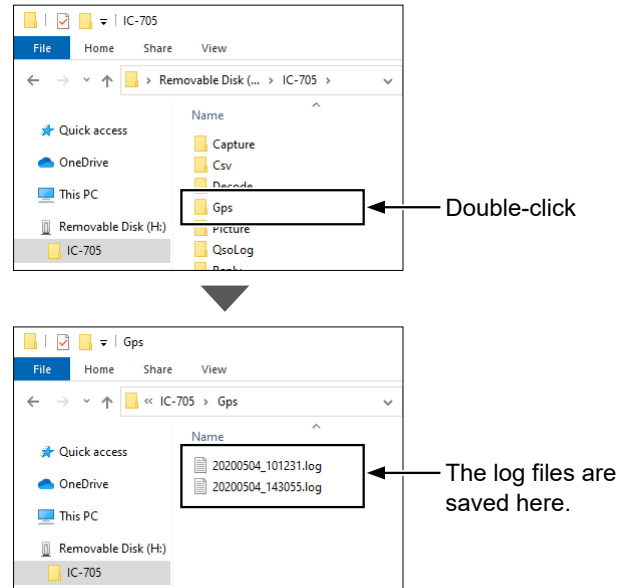

- The log files are displayed.

- ① The files are named with the time the log was started, in the following format:
yyyymmdd_hhmmss.log (yyyy: Year, mm: month, dd: day, hh: hour, mm: minute, ss: second).

6. Import the log file to a mapping software.

- You can see your route on the software map.
- ① The file may not be compatible with all mapping software.

TIP: You can display your route on Google Earth (free map software). Select “Open” in the <File> menu of Google Earth to open the log file.

- Your route is displayed on the map, as shown below.

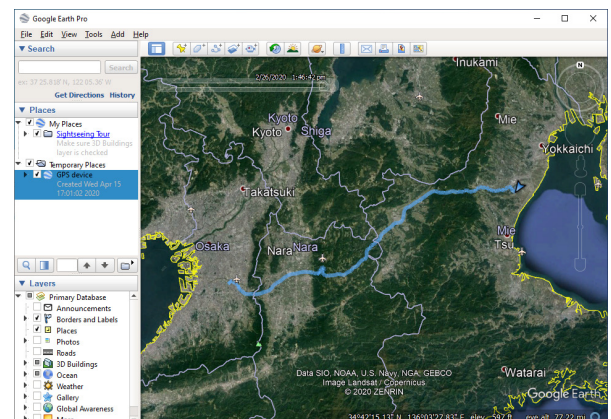

12. GPS OPERATION (ADVANCED)

GPS Logger function

TIP: About the recorded NMEA sentence for GPS logging

Regarding the GPS logging data of the IC-705, each sentence corresponds to the NMEA standard and is recorded in the following format.

◇ GGA sentence

(e.g.) \$GPGGA,161229.487,3723.2475,N,12158.3416,W,1,07,1.0,9.0,M,25.5,M,3.0000*18<CR><LF>
 ① ② ③ ④ ⑤ ⑥ ⑦ ⑧ ⑨ ⑩ ⑪ ⑫

- | | |
|------------------------------------------------------------------------------------------------------------------------------|--------------------------------------------------------------------|
| ① GGA protocol header (\$GPGGA) | ⑦ Horizontal Dilution of Precision (1.0) 0.0–50.0 |
| ② UTC of position (16:12:29.487) | ⑧ Altitude re: mean-sea-level (geoid), meters (9.0 meters) |
| ③ Latitude (North 37° 23.2475') N=North, S=South | ⑨ Geoidal separation, meters (25.5 meters) |
| ④ Longitude (West 121° 58.3416') E=East, W=West | ⑩ Age of Differential GPS data (3 seconds) |
| ⑤ GPS quality indicator (1)
0=Fix not available or invalid, 1=SPS mode
2=DGPS (SPS), 6=Estimated (Dead Reckoning) mode | ⑪ Check Sum (*18) Error detection data started with "*" (hex code) |
| ⑥ Number of satellites in use (7), 00–12 | ⑫ End code |
- *Blank shows when not positioned.

◇ RMC sentence

(e.g.) \$GPRMC,161229.487,A,3723.2475,N,12158.3416,W,0.13,309.62,311017,, ,D*10<CR><LF>
 ① ② ③ ④ ⑤ ⑥ ⑦ ⑧ ⑨ ⑩ ⑪

- | | |
|-----------------------------------------------------------------------------------------------------|------------------------------------------------------------------------------------------------------------------------------|
| ① RMC protocol header (\$GPRMC or \$GNRMC*)
* When both the GPS and GLONASS satellites are used. | ⑧ UTC date of position ('17 Oct 31st) ddmmyy |
| ② UTC of position (16:12:29.487) | ⑨ Mode Indicator (D)
A=Autonomous mode, D=DGPS,
E=Estimated (dead reckoning) mode,
N=Data not valid, R=Almanac data |
| ③ Status (A) A=Data valid
V=Data invalid/not positioned | ⑩ Check Sum (*10) Error detection data started with "*" (hex code) |
| ④ Latitude (North 37° 23.2475') N=North, S=South | ⑪ End code |
| ⑤ Longitude (West 121° 58.3416') E=East, W=West | *Blank shows when not positioned. |
| ⑥ Speed over ground (0.13 knots) | |
| ⑦ Course Over Ground (309.62°; degrees True)
0.00°–359.99° | |

◇ GSA sentence

(e.g.) \$GPGSA,A,3,07,02,26,27,09,04,, , , , ,15,1.8,1.0,1.5*33<CR><LF>
 ① ② ③ ④ ⑤ ⑥ ⑦ ⑧ ⑨

- | | |
|---------------------------------------------------------------------------------------------------------------------------------|--------------------------------------------------------------------|
| ① GSA protocol header (\$GPGSA or \$GNGSA*)
* When both the GPS and GLONASS satellites are used. | ⑤ Position Dilution of Precision (1.8) 0.0–50.0 |
| ② Mode indicator 1 (A)
M=Manual, forced to operate in 2D or 3D mode
A=Automatic, allowed to automatically switch 2D/3D | ⑥ Horizontal Dilution of Precision (1.0) 0.0–50.0 |
| ③ Mode indicator 2 (3)
1=Fix not available,
2=2D (using satellites; less than 3),
3=3D (using satellites; more than 4) | ⑦ Vertical Dilution of Position (1.5) 0.0–50.0 |
| ④ ID numbers of satellites used in solution (07, 02, 26, 27, 09, 04...15)
01–32 *Shows up to 12 ID's | ⑧ Check Sum (*33) Error detection data started with "*" (hex code) |
| | ⑨ End code |
| | *Blank shows when not positioned. |

◇ VTG sentence

(e.g.) \$GPVTG,309.62,T, ,M,0.13,N,0.2,K,A*03<CR><LF>
 ① ② ③ ④ ⑤ ⑥ ⑦ ⑧

- | | |
|-----------------------------------------------------------------------------------------------------|------------------------------------------------------------------------------------------------------------------------------|
| ① VTG protocol header (\$GPVTG or \$GNVTG*)
* When both the GPS and GLONASS satellites are used. | ⑥ Mode Indicator (A)
A=Autonomous mode, D=DGPS,
E=Estimated (dead reckoning) mode,
N=Data not valid, R=Almanac data |
| ② Course Over Ground (309.62°; degrees True)
0.00°–359.99° | ⑦ Check Sum (*03) Error detection data started with "*" (hex code) |
| ③ Course over ground degrees; Magnetic north | ⑧ End code |
| ④ Speed over ground, knots (0.13 knots) | *Blank shows when not positioned. |
| ⑤ Speed over ground, kilometer per hour (0.2 km/hr) | |

GPS SET

NOTE: The default settings shown below are for the USA transceiver version. The default settings may differ, depending on your transceiver version. To return to your transceiver version's default settings, push **QUICK** and touch "Default."

MENU » **GPS > GPS Set**

GPS Select (Default: ON)

Selects how to capture position data.

- OFF: A GPS receiver is not used.
- ON: Position data of the internal GPS receiver is used for the GPS functions.
- Manual: Manually enter the current Latitude, Longitude, and Altitude in "Manual Position."

MENU » **GPS > GPS Set > GPS Option**

SBAS (Default: ON)

Turns the SBAS (Satellite Based Augmentation System) function ON or OFF.

- ①When turning ON this function, the GPS position accuracy can be improved, but the transceiver's battery is quickly exhausted.
- OFF: Turns OFF the function.
 - ON: Turns ON the function.

GLONASS (Default: ON)

Selects whether or not to use the data from the GLONASS (GLOBAL'naya NAVigatsionnaya Sputnikovaya Sistema) satellites.

- ①When turning ON this function, the GPS position accuracy can be improved, but the transceiver's battery is quickly exhausted.
- OFF: Does not use the data from the GLONASS satellites.
 - ON: Uses the data from the GLONASS satellites.

Power Save (Default: Auto)

Selects whether or not to use the Power Save function for the internal GPS receiver.

When this function is ON, and if the GPS receiver does not receive signals from a satellite for 5 minutes, the function turns OFF the GPS receiver for this set period of time.

- OFF: The GPS receiver is always turned ON.
- 1, 2, 4, 8min:
When the receiver cannot receive signals from a satellite for 5 minutes, the GPS receiver is turned OFF for the selected period of time. (1, 2, 4, or 8 minutes). After this period, the receiver resumes receiving.
- Auto: When the receiver cannot receive signals from a satellite for 5 minutes, the GPS receiver is turned OFF for 1 minute. After this period, the receiver resumes receiving. The Power Save interval time extends to 2, 4, and then 8 minutes when receiving no signals for another 5 minutes, respectively.

Satellite Information Out (Default: GPS/QZSS/GLONASS)

Selects whether or not to output the data from the QZSS (Quasi-Zenith Satellite System) satellites and the GLONASS satellites.

- GPS/QZSS/GLONASS:
Outputs the data from the GPS satellites, the QZSS satellites, and the GLONASS satellites.
- GPS Only: Outputs the data from only the GPS satellites.

MENU » **GPS > GPS Set**

Manual Position

(Default: LATITUDE: 0°00.00'N,
LONGITUDE: 0°00.00'W, ALTITUDE: -----ft)

Manually enter the latitude, longitude, and Altitude of your current position.

- ①You can capture position data from the GPS receiver if "Capture From GPS" is selected.

12. GPS OPERATION (ADVANCED)

GPS SET

MENU » **GPS**

GPS TX Mode (Default: OFF)

Selects a GPS transmission mode to send GPS position data while in the DV mode.

- OFF: Does not transmit GPS data.
- D-PRS: Transmits GPS data in the D-PRS format.
- NMEA: Transmits GPS data in the NMEA format.

MENU » **GPS > GPS TX Mode > D-PRS**

Unproto Address (Default: API705,DSTAR*)

Displays an unproto address of up to 56 alphanumeric characters.

NOTE: You should use the default address, and editing is not recommended.

TX Format (Default: Position)

Selects the format to transmit the position data in the D-PRS mode.

- Position: The caller station is the mobile or base station.
- Object: Transmits a certain location's information, such as an event, earthquake, and so on. (The time stamp data is included.)
- Item: Transmits repeater or antenna information that needs no time information. (The time stamp data is not included.)
- Weather: Transmits weather information received from a weather device.

MENU » **GPS > GPS TX Mode > D-PRS > TX Format > Position**

Symbol (Default: Person)

Selects the symbol that indicates your operating situation. The selected symbol channel's symbol (1~4) is transmitted along with the position data.

Editing a symbol

1. Touch the symbol channel for 1 second.
2. Touch "Edit Symbol."
3. Push **QUICK**.
4. Touch "Direct Input."
5. Touch [+] / [-] to edit the first digit.
6. Touch [+] / [-] to edit the second digit.

Selectable characters and symbols
<For the first digit> /, \, 0 to 9, A to Z
<For the second digit> A to Z, a to z, 0 to 9, ! " # \$ % & ' () * + , - . / : ; < = > ? @ [\] ^ _ ` { } ~

7. After editing, touch [SET].
 - Sets the Symbol into the channel selected in step 1.

Editing a symbol

1. Touch the symbol channel for 1 second.
2. Touch "Edit Symbol."
3. Touch the symbol.
 - Sets the Symbol into the channel selected in step 1.

12. GPS OPERATION (ADVANCED)

GPS SET

SSID (Default: ---)

Selects an SSID based on APRS® to add to your call sign, to show your operating style to other stations. The additional methods of the SSID differ, depending on whether the call sign includes a space or not.

- ---: The space in call sign is converted to “-.”
 - ① If no text is entered after the space, the space will be deleted, and the space is not converted to “-.”
 - Example:** JA3YUA → JA3YUA
JA3YUA A → JA3YUA-A
- (-0): No SSID is added.
 - ① If a call sign includes a space, any text or digit after the space will be deleted.
 - Example:** JA3YUA → JA3YUA
JA3YUA A → JA3YUA
- -1 ~ -15: Adds an SSID of -1 to -15 to your call sign.
 - ① **Example:** SSID is “-9.”
JA3YUA → JA3YUA-9
JA3YUA A → JA3YUA-9
- -A ~ -Z: Adds an SSID of -A to -Z to your call sign.
 - ① **Example:** SSID is “-Z.”
JA3YUA → JA3YUA-Z
JA3YUA A → JA3YUA-Z

TIP: About the SSID

To assist in identifying a station’s type, designated call sign SSIDs are used in D-PRS (or APRS®), according to a common guideline. The guideline may be changed when the infrastructure environment, such as a product or network, is changed. Please check the latest guideline in the web site related to D-PRS and APRS®, and correctly set.

<http://aprs.org/aprs11/SSIDs.txt>

Comment

Enter a comment to transmit it with the D-PRS position data.

You can enter up to four comments.

The number of characters you can enter differs, depending on the Data Extension and Altitude settings.

Data Extension	Altitude	Characters entered (maximum)
OFF	OFF	43 (Default)
OFF	ON	35
Course/Speed	OFF	36
Course/Speed	ON	28
Power/Height/Gain/Directivity	OFF	36
Power/Height/Gain/Directivity	ON	28

The symbol “█” displays the transmittable comment range. Please note that the characters that exceed the range will not be transmitted.

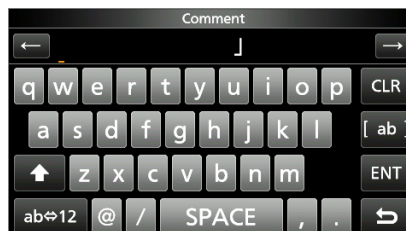

Transmittable comment range display (Example: up to 28 characters)

Time Stamp (Default: OFF)

Selects the transmitting time stamp type.

The time stamp is transmitted with the position data in the D-PRS mode, and UTC (Universal Time Coordinated) time is used.

- ① When your position is manually set, time stamp data is not transmitted.
- OFF: Does not transmit the time information.
- DHM: Transmits the time stamp in the Day, Hour, and Minute format.
- HMS: Transmits the time stamp in the Hour, Minute, and Second format.

12. GPS OPERATION (ADVANCED)

GPS SET

Altitude (Default: OFF)

Selects whether or not to transmit altitude data with the position data in the D-PRS mode.

- ① The number of characters you can enter in "Comment" differs, depending on the "Altitude" and "Data Extension" settings.
- OFF: No altitude data is transmitted.
 - ON: Transmits altitude data with position data.

Data Extension (Default: OFF)

Selects whether or not to transmit the Course/Speed data or the Power/Height/Gain/Directivity data with the position data in the D-PRS mode.

- ① The number of characters you can enter in "Comment" differs, depending on the "Altitude" and "Data Extension" settings.
- OFF: Does not transmit any information.
 - Course/Speed: Transmits the course and speed data with the position data.
 - ① The course and speed data are not transmitted when your location is manually set.
 - ① When transmitting with this setting, your station is regarded as a mobile station.
 - Power/Height/Gain/Directivity: Transmits the TX power level, height, antenna gain, and antenna direction, along with the position data.
 - ① The Power, Height, Gain, and Directivity data are transmitted even if your location is manually set.
 - ① When transmitting with this setting, your station is regarded as a base station.

Power (Default: 0W)

Selects the TX power level of the base station, to transmit along with the position data.

- ① This item is displayed when "Data Extension" is set to "Power/Height/Gain/Directivity."
- Select 0, 1, 4, 9, 16, 25, 36, 49, 64, or 81 W.

Height (Default: 10ft)

Selects the height of the base station's antenna, to transmit along with the position data.

- ① This item is displayed when "Data Extension" is set to "Power/Height/Gain/Directivity."
- Select 10, 20, 40, 80, 160, 320, 640, 1280, 2560, or 5120 feet.*
- * If the Altitude/Distance unit is set to "m," select 3, 6, 12, 24, 49, 98, 195, 390, 780, or 1561 meters.

Gain (Default: 0dB)

Selects the gain of the base station's antenna, to transmit along with the position data.

- ① This item is displayed when "Data Extension" is set to "Power/Height/Gain/Directivity."
- Select between 0 and 9 dB.

Directivity (Default: Omni)

Selects the direction the base station's antenna was pointing, to transmit along with the position data.

- ① This item is displayed when "Data Extension" is set to "Power/Height/Gain/Directivity."
- Select Omni, 45° NE, 90° E, 135° SE, 180°S, 225° SW, 270° W, 315° NW, or 360° N.

12. GPS OPERATION (ADVANCED)

GPS SET

MENU » GPS > GPS TX Mode > D-PRS
> TX Format > **Object**

Object Name

Enter an Object name of up to 9 characters.

Data Type (Default: Live Object)

Sets the Object's status.

- Live Object: The Object is valid.
- Killed Object: The Object is invalid.

Symbol (Default: Radio)

The symbol is an icon that indicates the Object's means of transportation or location. The saved symbol is transmitted along with the position data while in the D-PRS mode.

① See page 12-32 for details of editing a symbol.

Comment

Enter a comment to transmit it with the D-PRS position data.

The number of characters you can enter differs, depending on the Data Extension and Altitude data entry.

Data Extension	Altitude	Characters entered (maximum)
OFF	—	43 (Default)
OFF	Entered	35
Course/Speed	—	36
Course/Speed	Entered	28
Power/Height/Gain/Directivity	—	36
Power/Height/Gain/Directivity	Entered	28

The symbol “**J**” displays the transmittable comment range. Please note that the characters that exceed the range will not be transmitted.

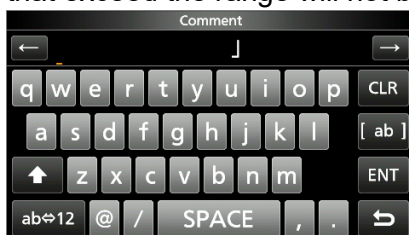

Transmittable comment range display
(Example: up to 28 characters)

Position

(Default: LATITUDE: 0°00.00'N,
LONGITUDE: 0°00.00'W, ALTITUDE: -----ft)

Displays the position information of the Object. Push **QUICK** to open the QUICK MENU screen shown below.

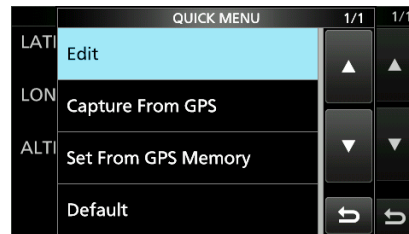

TIP: When you select “Capture From GPS” or “Set From GPS Memory,” you can capture the position from the GPS, or set the Object's position from the GPS memory.

Entering the position information manually

1. Touch “Edit” on the QUICK MENU screen.
 - The POSITION EDIT screen is displayed.
2. Touch “LATITUDE.”
3. Enter a latitude.
 - ① Touch “N/S” to switch the north latitude and the south latitude.
4. Touch [ENT].
5. Touch “LONGITUDE.”
6. Enter a longitude.
 - ① Touch “E/W” to switch the east longitude and the west longitude.
7. Touch [ENT].
8. Touch “ALTITUDE.”
9. Enter an altitude.
 - ① After entering, touch [+/-] to switch “+” and “-.”
10. Touch [ENT].
11. Touch “<<Write>>.”
12. Touch [YES].
 - The position information is entered.

12. GPS OPERATION (ADVANCED)

GPS SET

Data Extension (Default: OFF)

Selects whether or not to transmit the Course/Speed data or the Power/Height/Gain/Directivity data with the position data in the D-PRS mode.

① The number of characters you can enter in “Comment” differs, depending on the “Altitude” and “Data Extension” settings.

- OFF: Does not transmit any information.
- Course/Speed: Transmits the course and speed data with the position data.
- Power/Height/Gain/Directivity: Transmits the TX power level, height, antenna gain, and antenna direction, along with the position data.

Course (Default: 0°)

Sets the Object’s course to between 0° and 360°.

① This item is displayed when “Data Extension” is set to “Course/Speed.”

Speed (Default: 0mph)

Sets the Object’s speed to between 0 and 1150 mph.*

* If the Speed unit is set to “km/h,” set to between 0 to 1850 km/h, or set to “knots,” set to between 0 and 999 knots.

① This item is displayed when “Data Extension” is set to “Course/Speed.”

Power (Default: 0W)

Selects the TX power level of Object, to transmit along with the position data.

① This item is displayed when “Data Extension” is set to “Power/Height/Gain/Directivity.”

- Select 0, 1, 4, 9, 16, 25, 36, 49, 64, or 81 W.

Height (Default: 10ft)

Selects the height of the Object’s antenna, to transmit along with the position data.

① This item is displayed when “Data Extension” is set to “Power/Height/Gain/Directivity.”

- Select 10, 20, 40, 80, 160, 320, 640, 1280, 2560, or 5120 feet.*

* If the Altitude/Distance unit is set to “m,” select 3, 6, 12, 24, 49, 98, 195, 390, 780, or 1561 meters.

Gain (Default: 0dB)

Selects the gain of the Object’s antenna, to transmit along with the position data.

① This item is displayed when “Data Extension” is set to “Power/Height/Gain/Directivity.”

- Select between 0 and 9 dB.

Directivity (Default: Omni)

Selects the direction the Object’s antenna was pointing, to transmit along with the position data.

① This item is displayed when “Data Extension” is set to “Power/Height/Gain/Directivity.”

- Select Omni, 45° NE, 90° E, 135° SE, 180° S, 225° SW, 270° W, 315° NW, or 360° N.

SSID (Default: ---)

Selects an SSID based on APRS® to add to your call sign, to show your operating style to other stations. The additional methods of the SSID differ, depending on whether the call sign includes a space or not.

① See page 12-33 for details of the SSID.

- ---: The space in call sign is converted to “_.”
- (-0): No SSID is added.
- -1 ~ -15: Adds an SSID of -1 to -15 to your call sign.
- -A ~ -Z: Adds an SSID of -A to -Z to your call sign.

Time Stamp (Default: OFF)

Selects the transmitting time stamp type.

The time stamp is transmitted with the position data in the D-PRS mode, and UTC (Universal Time Coordinated) time is used.

- DHM: Transmits the time stamp in the Day, Hour, and Minute format.
- HMS: Transmits the time stamp in the Hour, Minute, and Second format.

12. GPS OPERATION (ADVANCED)

GPS SET

MENU » GPS > GPS TX Mode > D-PRS
> TX Format > Item

Item Name

Enter an Item name of up to 9 characters.

Data Type (Default: Live Object)

Sets the Item's status.

- Live Object: The Item is valid.
- Killed Object: The Item is invalid.

Symbol (Default: Radio)

The symbol is an icon that indicates the Item's means of transportation or location. The saved symbol is transmitted along with the position data while in the D-PRS mode.

① See page 12-32 for details of editing a symbol.

Comment

Enter a comment to transmit it with the D-PRS position data.

The number of characters you can enter differs, depending on the Data Extension and Altitude data entry.

Data Extension	Altitude	Characters entered (maximum)
OFF	—	43 (Default)
OFF	Entered	35
Course/Speed	—	36
Course/Speed	Entered	28
Power/Height/Gain/Directivity	—	36
Power/Height/Gain/Directivity	Entered	28

The symbol “” displays the transmittable comment range. Please note that the characters that exceed the range will not be transmitted.

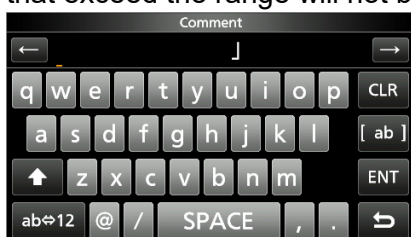

Transmittable comment range display
(Example: up to 28 characters)

Position

(Default: LATITUDE: 0°00.00'N,
LONGITUDE: 0°00.00'W, ALTITUDE: -----ft)

Displays the position information of the Item.

Push **QUICK** to open the QUICK MENU screen shown below.

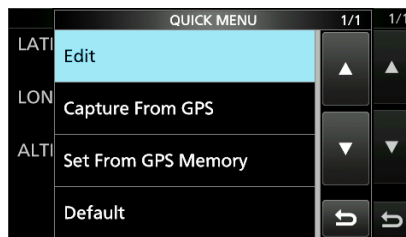

TIP: When you select “Capture From GPS” or “Set From GPS Memory,” you can capture the position from the GPS, or set the Item's position from the GPS memory.

① See page 12-35 to enter the position information manually.

Data Extension (Default: OFF)

Selects whether or not to transmit the Course/Speed data or the Power/Height/Gain/Directivity data with the position data in the D-PRS mode.

① The number of characters you can enter in “Comment” differs, depending on the “Altitude” and “Data Extension” settings.

- OFF: Does not transmit any information.
- Course/Speed: Transmits the course and speed data with the position data.
- Power/Height/Gain/Directivity: Transmits the TX power level, height, antenna gain, and antenna direction, along with the position data.

Course (Default: 0°)

Sets the Item's course to between 0° and 360°.

① This item is displayed when “Data Extension” is set to “Course/Speed.”

12. GPS OPERATION (ADVANCED)

GPS SET

Speed (Default: 0mph)

Sets the Item's speed to between 0 and 1150 mph.*

* If the Speed unit is set to "km/h," set to between 0 to 1850 km/h, or set to "knots," set to between 0 and 999 knots.

① This item is displayed when "Data Extension" is set to "Course/Speed."

Power (Default: 0W)

Selects the TX power level of Item, to transmit along with the position data.

① This item is displayed when "Data Extension" is set to "Power/Height/Gain/Directivity."

- Select 0, 1, 4, 9, 16, 25, 36, 49, 64, or 81 W.

Height (Default: 10ft)

Selects the height of the Item's antenna, to transmit along with the position data.

① This item is displayed when "Data Extension" is set to "Power/Height/Gain/Directivity."

- Select 10, 20, 40, 80, 160, 320, 640, 1280, 2560, or 5120 feet.*

* If the Altitude/Distance unit is set to "m," select 3, 6, 12, 24, 49, 98, 195, 390, 780, or 1561 meters.

Gain (Default: 0dB)

Selects the gain of the Item's antenna, to transmit along with the position data.

① This item is displayed when "Data Extension" is set to "Power/Height/Gain/Directivity."

- Select between 0 and 9 dB.

Directivity (Default: Omni)

Selects the direction the Item's antenna was pointing, to transmit along with the position data.

① This item is displayed when "Data Extension" is set to "Power/Height/Gain/Directivity."

- Select Omni, 45° NE, 90° E, 135° SE, 180°S, 225° SW, 270° W, 315° NW, or 360° N.

SSID (Default: ---)

Selects an SSID based on APRS® to add to your call sign, to show your operating style to other stations. The additional methods of the SSID differ, depending on whether the call sign includes a space or not.

① See page 12-33 for details of the SSID.

- ---: The space in call sign is converted to "-."
- (-0): No SSID is added.
- -1 ~ -15: Adds an SSID of -1 to -15 to your call sign.
- -A ~ -Z: Adds an SSID of -A to -Z to your call sign.

12. GPS OPERATION (ADVANCED)

GPS SET

MENU » GPS > GPS TX Mode > D-PRS
> TX Format > **Weather**

Symbol (Default: WX Station)

The symbol is an icon that indicates the weather station's means of transportation or location.

The saved symbol is transmitted along with the position data while in the D-PRS mode.

① See page 12-32 for details of editing a symbol.

SSID (Default: ---)

Selects an SSID based on APRS® to add to your call sign, to show your operating style to other stations. The additional methods of the SSID differ, depending on whether the call sign includes a space or not.

① See page 12-33 for details of the SSID.

- ---: The space in call sign is converted to “-.”
- (-0): No SSID is added.
- -1 ~ -15: Adds an SSID of -1 to -15 to your call sign.
- -A ~ -Z: Adds an SSID of -A to -Z to your call sign.

Comment

Enter a comment to transmit it with the D-PRS position data, up to 43 characters.

Time Stamp (Default: OFF)

Selects the transmitting time stamp type.

The time stamp is transmitted with the position data in the D-PRS mode, and UTC (Universal Time Coordinated) time is used.

- OFF: Does not transmit the time information.
- DHM: Transmits the time stamp in the Day, Hour, and Minute format.
- HMS: Transmits the time stamp in the Hour, Minute, and Second format.

12. GPS OPERATION (ADVANCED)

GPS SET

MENU » **GPS > GPS TX Mode > NMEA**

GPS Sentence (Default: GGA)

Selects sentences to be transmitted in the GPS mode to transmit position data. The selectable sentences are RMC, GGA, GLL, VTG, GSA, and GSV.

NOTE: Set the GSV sentence to OFF when sending the GPS message to conventional digital transceivers. (p. 12-1)
The GSV sentence is incompatible with them.

Information

- Up to 4 GPS sentences can be set at a time.
- Displays “✓” when the sentence is set to ON.
- “VTG,” “GSA,” and “GSV” sentences are not transmitted when your location has been manually set.

GPS Message

Enter a GPS message of up to 20 alphanumeric characters. (p. 12-18)

NOTE: When you do not want to send a message, delete the entered message.

MENU » **GPS**

GPS Information

Displays the GPS satellite direction, elevation angle, satellite number, and receiving status. (p. 12-7)

TIP: Contents of GPS sentence

The Time Stamp is displayed based on the UTC (Universal Time Coordinated) time.

Sentence	Lon/Lat	Alt	GPS Time Stamp (UTC)	Date (UTC)	Status	2D/3D	COG (True)	SOG (knot)
RMC	✓		✓	✓	✓			✓
GGA	✓	✓	✓		✓			
GLL	✓		✓		✓			
VTG							✓	✓
GSA					✓	✓		
GSV								

Sentence	Others
RMC	Magnetic variation, Mode Indicator
GGA	Number of satellites in use, HDOP, Geoidal separation, Age of Differential GPS data, Differential reference station ID
GLL	Mode Indicator
VTG	COG (Magnetic north), SOG (km/h), Mode Indicator
GSA	PRN number of satellites used in solution, PDOP, HDOP, VDOP
GSV	Total number of sentences, Sentence number, Total number of satellites in view, Satellite information (ID, Elevation, Azimuth, S/N)

12. GPS OPERATION (ADVANCED)

GPS SET

MENU » **GPS**

GPS Position

Your current position, received position, or GPS Memory Alarm position information is displayed. (p. 12-2)

Rotating **(MAIN DIAL)** selects the MY, RX, MEM, and ALM screens.

MY screen (MY Position)

Compass*	Displays your direction.
Latitude	Displays your latitude.
Longitude	Displays your longitude.
GL	Displays the grid locator based on the latitude and longitude of your location.
ALT	Displays your own altitude.
SPEED	Displays your speed over the ground.
TIME	Displays current time received from the GPS.
COURSE	Displays your direction heading.

① When “GPS Select” is set to “Manual,” the screen displays only latitude, longitude, altitude, GL (Grid locator), and time (internal clock).

RX screen (Received position data of the other station)
Depending on the caller’s TX mode or TX format, the displayed items and these meanings are different. The following lists describe the items for each category. No data is displayed when no position data is received on your transceiver.

<1. When the caller’s TX mode is NMEA>

Compass*	Displays the caller’s direction from your location.
Latitude	Displays the caller’s latitude.
Longitude	Displays the caller’s longitude.
GL	Displays the grid locator based on the latitude and longitude of the caller’s location.
ALT	Displays the caller’s altitude.
DST	Displays the caller’s distance from your location.
COURSE	Displays the caller’s direction over the ground.
SPEED	Displays the caller’s speed.
GPS Time Stamp	Displays the time that the caller acquired the position data.
Call sign	Displays the caller’s call sign.

<2. When the caller’s TX format is D-PRS Position (Mobile station)>

Compass*	Displays the caller’s direction from your location.
Latitude	Displays the caller’s latitude.
Longitude	Displays the caller’s longitude.
GL	Displays the grid locator based on the latitude and longitude of the caller’s location.
ALT	Displays the caller’s altitude.
DST	Displays the caller’s distance from your location.
COURSE	Displays the caller’s direction over the ground.
SPEED	Displays the caller’s speed.
Symbol	Displays the caller’s D-PRS symbol.
SSID	Displays the caller’s SSID.
GPS Time Stamp	Displays the time that the caller acquired the position data.
Call sign	Displays the caller’s call sign (with SSID).

* You can change the display type in the QUICK MENU screen.

12. GPS OPERATION (ADVANCED)

GPS SET

MENU » **GPS**

GPS Position (continued)

<3. When the caller's TX format is D-PRS Position (Base station)>

Compass*	Displays the caller's direction from your location.
Latitude	Displays the caller's latitude.
Longitude	Displays the caller's longitude.
GL	Displays the grid locator based on the latitude and longitude of the caller's location.
ALT	Displays the caller's altitude.
DST	Displays the caller's distance from your location.
POWER	Displays the caller's TX power level.
HEIGHT	Displays the caller's antenna height.
GAIN	Displays the caller's antenna gain.
DIRECT	Displays the direction of the caller's antenna was pointing.
Symbol	Displays the caller's D-PRS symbol.
SSID	Displays the caller's SSID.
GPS Time Stamp	Displays the time that the caller acquired the position data.
Call sign	Displays the caller's call sign (with SSID).

<4. When the caller's TX format is D-PRS Object/Item>

Compass*	Displays the Object/Item's direction from your location.
Object/Item name	Displays the Object/Item's name.
Latitude	Displays the Object/Item's latitude.
Longitude	Displays the Object/Item's longitude.
GL	Displays the grid locator based on the latitude and longitude of the Object/Item's location.
ALT	Displays the Object/Item's altitude.
DST	Displays the Object/Item's distance from your location.
COURSE	Displays the Object/Item's direction over the ground.
SPEED	Displays the Object/Item's speed.
POWER	Displays the Object/Item's TX power level.
HEIGHT	Displays the Object/Item's antenna height.
GAIN	Displays the Object/Item's antenna gain.
DIRECT	Displays the direction that the Object/Item's antenna was pointing.
Symbol	Displays the Object/Item's D-PRS symbol.
SSID	Displays the caller's SSID.
GPS Time Stamp	Displays the time that the caller sent the Object's data.
Call sign	Displays the caller's call sign (with SSID).

① When the Object or Item is disabled, "KILLED" is displayed.

* You can change the display type in the QUICK MENU screen.

12. GPS OPERATION (ADVANCED)

GPS SET

MENU » **GPS**

GPS Position (continued)

<5. When the caller's TX format is D-PRS Weather>

Compass*	Displays the caller's direction from your location.
Latitude	Displays the caller's latitude.
Longitude	Displays the caller's longitude.
GL	Displays the grid locator based on the latitude and longitude of the caller's location.
DST	Displays the caller's distance from your location.
TEMP	Displays the temperature of the caller station's area.
RAIN	Displays the rainfall of the caller station's area.
WIND DIR	Displays the wind direction of the caller station's area.
WIND SPD	Displays the wind speed of the caller station's area.
BARO	Displays the barometric pressure of the caller station's area.
HUMI	Displays the humidity of the caller station's area.
Symbol	Displays the caller's D-PRS symbol.
SSID	Displays the caller's SSID.
GPS Time Stamp	Displays the time that the caller acquired the position data.
Call sign	Displays the caller's call sign (with SSID).

MEM screen (GPS memory position)

Compass*	Displays GPS Memory channel's direction from your location.
Latitude	Displays GPS Memory channel's latitude.
Longitude	Displays GPS Memory channel's longitude.
GL	Displays the grid locator based on the latitude and longitude of the GPS Memory channel.
DST	Displays GPS Memory channel's distance from your location.
GPS memory name	Displays the caller's call sign (with SSID).

① You can change the GPS Memory in the QUICK MENU screen.

ALM screen (GPS alarm position)

Compass*	Displays GPS Alarm area's direction from your location.
Latitude	Displays GPS Alarm area's latitude.
Longitude	Displays GPS Alarm area's longitude.
GL	Displays the grid locator based on the latitude and longitude of the GPS Alarm area.
DST	Displays GPS Alarm area's distance from your location.
GPS Alarm	Displays "RX," GPS memory group name, or GPS memory name specified for the GPS Alarm function.

① You can change the GPS Alarm in the QUICK MENU screen.

* You can change the display type in the QUICK MENU screen.

12. GPS OPERATION (ADVANCED)

GPS SET

MENU » **GPS**

GPS Memory

The transceiver has 300 GPS memories to save the received position data, or often-used position data, with an alphanumeric memory name. The channels can be divided into the “(No Group)” group and each Memory group (A to Z) for easy Memory management.

The display of the GPS MEMORY screen

(No Group)	GPS Memories not assigned to any group
A ~ Z: Group Name	GPS Memories assigned to the selected group.

GPS Memory Groups (A ~ Z)

GROUP NAME	GPS Memory Group name (Up to 16 alphanumeric characters)
------------	-------------------------------------------------------------

① You can edit the GPS Memory Group name.
(p. 12-21)

GPS Memories

NAME	GPS memory name (Up to 16 alphanumeric characters)
DATE	Saved date
TIME	Saved time
LATITUDE	Saved position (latitude)
LONGITUDE	Saved position (longitude)
ALTITUDE	Saved altitude
GROUP	The group letter and the name of the group

- ① When you save the received position data on the GPS POSITION screen, the received station's call sign is used as the GPS Memory name.
- ① In the QUICK MENU screen, you can edit the GPS Memory contents, such as the GPS Memory name.

MENU » **GPS > GPS Alarm**

Alarm Select (Default: OFF)

Selects the target positions for the GPS Alarm function.

- OFF: Turns OFF the function.
- RX: The GPS Alarm sounds when a target (the last received position) enters your active alarm range.
- Group: The GPS Alarm sounds when a target (positions in the GPS Memory, or in the selected GPS Memory Group) enters your active alarm range.
- Memory: The GPS Alarm sounds when a target (the entered position in the GPS Memory) enters your active alarm range.

Alarm Area (Group) (Default: 0.25')

Sets the GPS active alarm range. When a target enters this set active alarm range, the GPS Alarm sounds, and the GPS Alarm icon blinks.

① When “Alarm Select” is set to “Group,” this setting is enabled.

Ranges differ, depending on the Latitude/Longitude unit setting.

- Latitude/Longitude = ddd°mm.mm'
Ranges: 00.08' to 59.99' (0.01' steps)
- Latitude/Longitude = ddd°mm'mm"
Ranges: 00'05" to 59'59" (0'01" steps)

Example:

When a target enters the active alarm range, the GPS Alarm sounds, and the GPS alarm icon blinks.

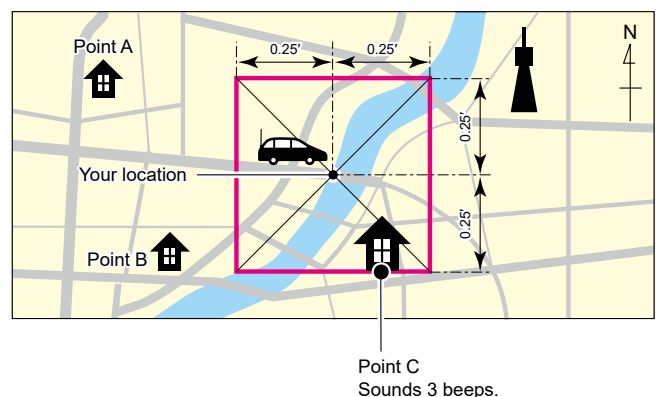

12. GPS OPERATION (ADVANCED)

GPS SET

MENU » **GPS > GPS Alarm**

Alarm Area (RX/Memory) (Default: Both)

Selects the GPS active alarm range.

When a target enters the active alarm range, the GPS Alarm sounds, and the GPS alarm icon blinks.

① When "Alarm Select" is set to "RX" or "Memory," this setting is enabled. (p. 12-44)

- **Limited:** The transceiver sounds 3 beeps, and the GPS Alarm icon blinks when the target enters the 500 meters range.
- **Extended:** The transceiver sounds 3 beeps, and the GPS Alarm icon blinks when the target enters the 1 kilometer range.
- **Both:** The transceiver sounds a beep, and the GPS Alarm icon blinks when the target enters the 1 kilometer range, and sounds 3 beeps, and the icon blinks when it enters the 500 meters range. When the target exits the 500 meters range, but is still in the 1 kilometer range, the icon continues to blink, but no beeps sound.

Example:

When a target station enters the active alarm range (500 meters or 1 kilometer range, depending on the setting), the GPS Alarm sounds and the GPS Alarm icon blinks.

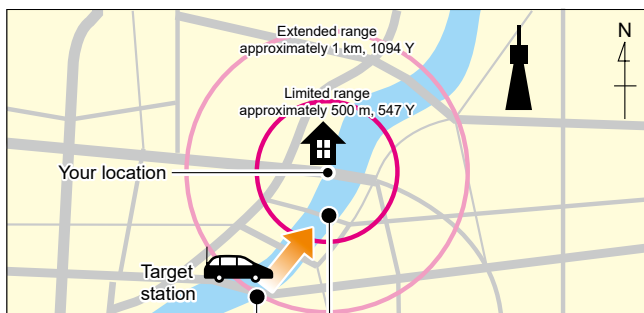

Sounds a beep. Sounds 3 beeps.

MENU » **GPS > GPS Logger**

GPS Logger (Default: ON)

Turns the GPS Logger function ON or OFF.

This function logs the position, altitude, course, speed, and a number of satellites being used.

- **OFF:** Turns OFF the function.
- **ON:** The transceiver automatically logs GPS data. Once this function is turned ON, the GPS data will be continuously logged until turning it OFF, even if the transceiver power is turned OFF, then ON again.

① This function requires a microSD card (User supplied).

① When "GPS select" is set to "OFF" or "Manual," this function does not save the log.

TIP: The log data is saved on the microSD card. The file name is automatically created, as shown below:

- Log start date and time: 1st January 2020 15:30:00
- File name: 20200101_153000.csv

Record Interval (Default: 10sec)

Sets the GPS Logger function record interval to 1, 5, 10, 30, or 60 seconds.

Record Sentence

(Default: RMC/ GGA/ VTG/ GSA)

Sets the GPS Logger function record sentence to RMC, GGA, VTG, or GSA.

- Displays "✓" when the sentence is set.

NOTE: Select at least one sentence, otherwise an error beep will sound.

12. GPS OPERATION (ADVANCED)

GPS SET

MENU » **GPS**

GPS Auto TX (Default: OFF)

Selects an option for the GPS automatic transmission function.

This function automatically transmits the current position data received from a GPS receiver, as well as any entered GPS message, at the set interval.

NOTE: When “GPS TX Mode” is “NMEA,” set “GPS Select” to “ON.” If you set to “Manual” or “OFF,” the current position data is automatically transmitted.

- OFF: Does not automatically transmit the position data. (When you push [PTT], the transceiver transmits the position data.)
- 30 sec to 30 min:
Transmits the current position data at the selected interval (30 seconds, or 1, 3, 5, 10, or 30 minutes).

13. D-STAR OPERATION (BASIC)

Unique features of D-STAR

- Easy Cross band operation through a repeater

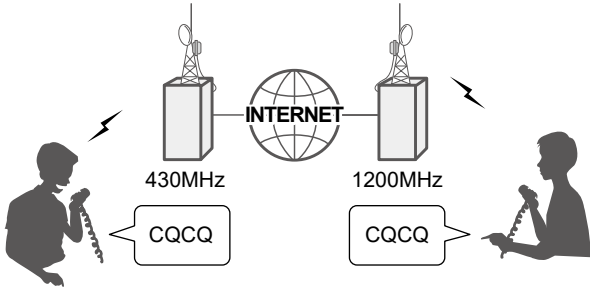

- Easy call sign entry with the Repeater list or TX/RX History
- The Call Sign Capture key **AUTOTUNE (RX-CS)** makes call sign capture easy!

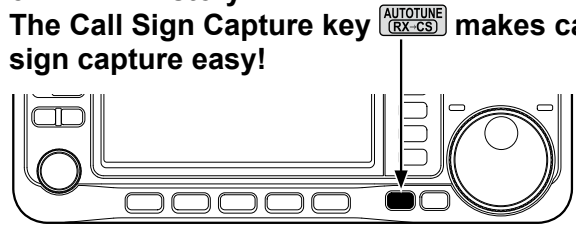

IMPORTANT! Before starting D-STAR, the following steps are required.

- STEP 1** Enter your call sign (MY) into the transceiver. (p. 13-3)
 - STEP 2** Register your call sign (MY) to a gateway repeater. (p. 13-4)
 - STEP 3** Enter your D-STAR equipment into your registration form. (p. 13-4)
- ▶ You have completed the steps!!

What is D-STAR?

- D-STAR is a digital protocol standard developed by the Japan Amateur Radio League (JARL). The system includes the DV mode for Digital Voice and the DD mode for Digital Data communications.
- D-STAR supports a comprehensive repeater system linked through the Internet, enabling you to make QSOs with stations near or far from your location.
- D-STAR supports the DV mode at 4.8 kbps. Your call sign data, and either a short message, or GPS data can be transmitted simultaneously with your voice signal.

Advanced Amateur radio technology of D-STAR

The DV mode has a bandwidth of only 6 kHz, compared to 16 kHz for the analog FM mode, with 5 kHz deviation.

D-STAR utilizes the well-known GMSK modulation method that makes very efficient use of occupied bandwidth.

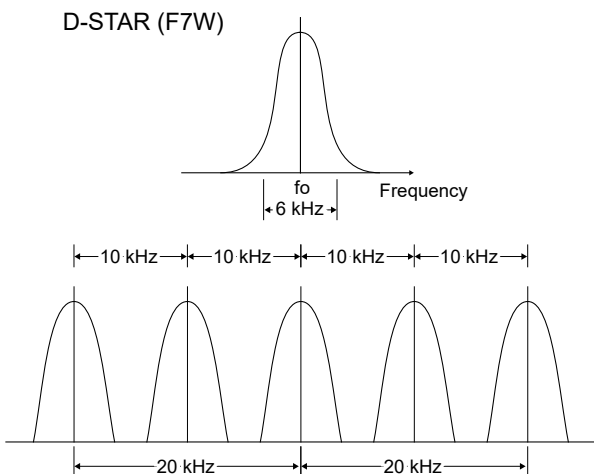

D-STAR occupies 10 kHz. The sound quality is good, even though the bandwidth is narrow.

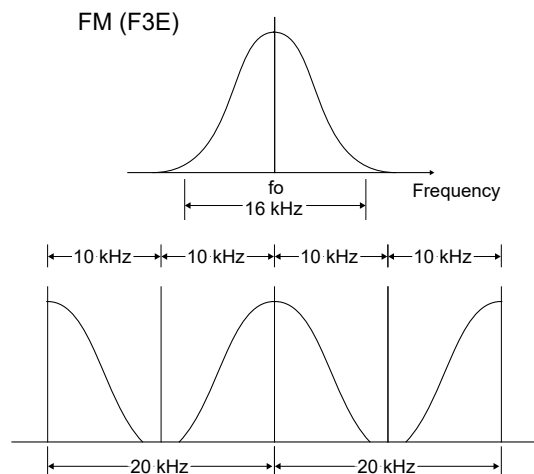

The regular FM mode occupies 20 kHz that is double the bandwidth of D-STAR.

13. D-STAR OPERATION (BASIC)

About the DR function

You can easily use D-STAR repeaters with the D-STAR Repeater (DR) function. With this function, you can select the preset repeater or frequency in "FROM" (access repeater), and a target call sign in "TO" (destination) on the DR screen, as shown right.

NOTE: If the repeater set in "FROM" (Access Repeater) has no Gateway, you cannot make a Gateway call.

To display the DR screen, hold down **DR** for 1 second.

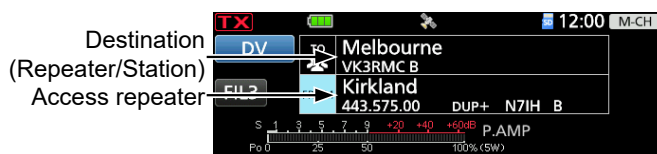

Ways to Communicate with the DR function

With the DR function, the transceiver has 3 ways to communicate.

Local Area call: To call through your local area (access) repeater.

① You can use an FM repeater.

Gateway call: To call through your local area (access) repeater, repeater gateway, and the Internet to your destination repeater or individual station's last used repeater, using Call Sign Routing.

Simplex call: To call another station not using a repeater.

NOTE:

- Using the repeater list is required to use the DR function. (p. 13-15)
- Before operating in the Duplex mode, BE SURE to check whether the repeater is busy or not. If the repeater is busy, wait until it is clear, or ask for a 'break' using a method acceptable to your local procedures.
- The transceiver has the Time-Out Timer function for the DV Repeater operation. The timer limits a continuous transmission. Warning beeps will sound approximately 30 seconds before time-out and then again immediately before the time-out.

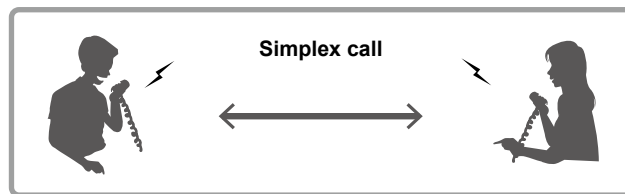
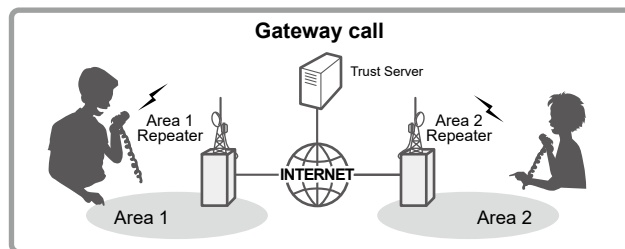
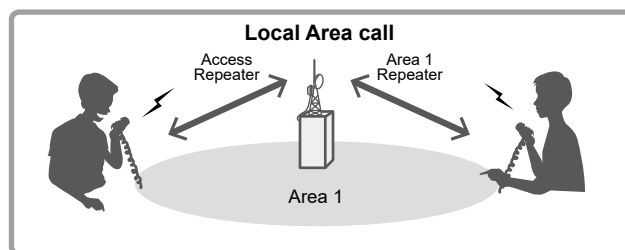

To begin Digital mode communication using other than the DR function

To begin Digital mode communication using other than the DR function, you can use the VFO mode, Memory mode, or Call Channel mode. This manual description focuses on the DR function operation, which can be easily set up. If you want to use other than the DR function, see the procedures as described to the right, or select a repeater in a Memory channel.

For a Local area call or Gateway call:

1. Set the access repeater's frequency.
2. Set the Duplex direction and frequency offset. (p. 2-17)
3. Set the call signs (UR/R1/R2). (p. 14-35)

For a Simplex call:

1. Set the operating frequency.
2. Set the call signs (UR/R1/R2). (p. 14-35)

Enter your call sign (MY) into the transceiver

To operate D-STAR, you must first enter your call sign into the MY call sign memory. You can enter up to 6 MY call signs.

NOTE:

- Your MY call sign must match the call sign registered on a gateway repeater. (p. 13-4)
- The MY Call sign in the instructions is **ONLY** an example that is used in explanations. You **MUST** enter your own call sign, the one that was assigned to you and is on your license.

Example: Enter “JA3YUA” as your own call sign into “1.”

1. Open the MY CALL SIGN screen.
MENU » SET > My Station > My Call Sign

2. Touch the number for 1 second.

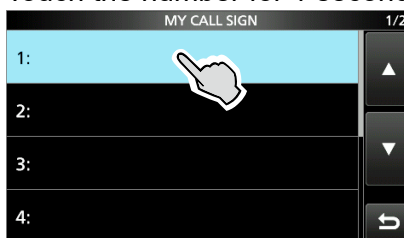

3. Touch “Edit.”

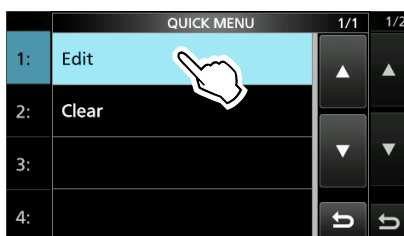

4. Enter your own call sign, then touch [ENT].

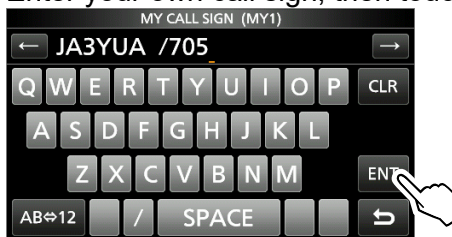

5. Touch the entered call sign.

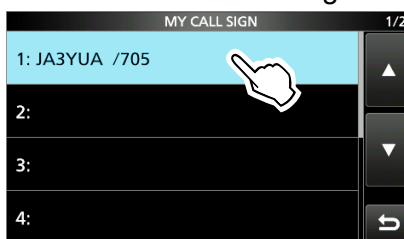

- Sets the call sign to be used as MY call sign.

6. To close the MY STATION screen, push QUICK several times.

TIP: You can enter a note of up to 4 characters, such as the model of the transceiver, name, area name, after your call sign.

13. D-STAR OPERATION (BASIC)

Register your call sign at a gateway repeater

To make a Gateway call through the Internet, you must register your call sign at a repeater that has a gateway, usually one near you.

About the registration process described:

This section describes the call sign registration process at a repeater that is connected to the US Trust server.

There are other systems as well, and they have their own registration process. For information on how to register on one of them, contact the administrator of a repeater that uses the alternate system.

NOTE: If needed, ask the gateway repeater administrator for call sign registration instructions.

Step 1: Access the call sign registration screen

1. Access the following URL to find the gateway repeater closest to you.
<http://www.dstarusers.org/repeaters.php>
2. Click the call sign of the repeater that you want to register to.
3. Click the "Gateway Registration URL:" link address.
 - The "D-STAR Gateway System" screen is displayed.
4. Click <Register> to start the New User registration.

D-STAR Gateway System (日本語)

Already registered?
Login with Callsign and Password
Please note that Callsign and Password are case sensitive!
Callsign must be in Upper Case!

CallSign:
Password:

Login

New user?
Register here for D-STAR access.
Registering takes just a few seconds, and you won't have to enter your personal information again the next time you visit here.

Register Click

D-STAR is a digital protocol developed by the Japan Amateur Radio League (the JARL) and stands for Digital Smart Technology for Amateur Radio.

Step 2: Register your call sign

1. Follow the registration instructions found there.
2. When you receive a notification from the administrator, your call sign registration has been approved.

NOTE: It may take a few days for the administrator to approve you.

Step 3: Register your personal information

After your registration is approved, log in your personal account with your registered call sign and password.

D-STAR Gateway System (日本語)

Already registered?
Login with Callsign and Password
Please note that Callsign and Password are case sensitive!
Callsign must be in Upper Case!

CallSign:
Password:

Login Click

New user?
Register here for D-STAR access.
Registering takes just a few seconds, and you won't have to enter your personal information again the next time you visit here.

Register

D-STAR is a digital protocol developed by the Japan Amateur Radio League (the JARL) and stands for Digital Smart Technology for Amateur Radio.

Step 4: Register your D-Star equipment

1. Register your D-STAR equipment information. Ask the gateway repeater administrator for details.
2. When your registration is complete, log out of your personal account, and start using the D-STAR network.

NOTE: You must register your D-STAR equipment **BEFORE** you can make Gateway Repeater calls.

13. D-STAR OPERATION (BASIC)

IMPORTANT!

- The repeater list, described in this manual, may differ from your transceiver's preloaded contents.
- Although Japanese repeaters are used in the setting examples, the Japanese repeater node (port) letters are different from other country's.

BE SURE to add the repeater node letter in the 8th digit of the call sign, according to the frequency band shown below.

1200 MHz : A (B in Japan)

430 MHz : B (A in Japan)

144 MHz : C (no D-STAR repeaters in Japan)

Making a Simplex call

This section describes simplex operation (through no repeater).

NOTE: The frequencies may be different, depending on the transceiver's version. Check for usable frequencies for your operating area.

What is a Simplex Call?

A simplex call is a direct call to another station on a single frequency, not using a repeater.

Example: Making a simplex call on 445.670 MHz.

Step 1: Set "FROM" (Simplex channel)

1. Hold down **[DR]** for 1 second to display the DR screen.
2. Touch "FROM" to select, and then touch "FROM" again.

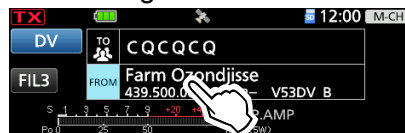

3. Touch "Repeater List."

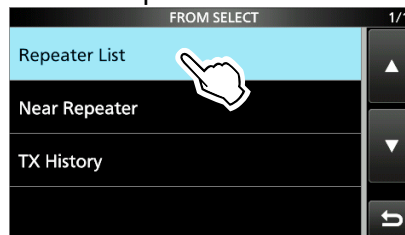

4. Touch "Simplex."
5. Touch the desired frequency.
(Example: 445.670 MHz)

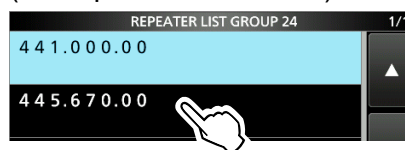

- Return to the DR screen, and the selected frequency is displayed in "FROM."
- "CQCQCQ" is displayed in "TO."
- ① If a station call sign is set in "TO," select "Local CQ" in the "TO SELECT" screen to set "CQCQCQ" in "TO."

Step 2: Hold down [PTT] to transmit

Hold down [PTT] to transmit.

TIP: You can change the simplex frequencies.
(p. 14-28)

[MENU] » **DV MEMORY > Repeater List > Simplex**

Accessing repeaters

This section describes how to check whether or not you can access a local area repeater (Access repeater), and if your signal is successfully sent to a destination repeater.

TIP: If your call sign (MY) has not been set, or your call sign and equipment have not been registered at a D-STAR repeater, see pages 13-3, 13-4.

Step 1: Set "FROM" (Access repeater)

1. Hold down **[DR]** for 1 second to display the DR screen.
2. Touch "FROM" to select, and then touch "FROM" again.



3. Touch "Repeater List."

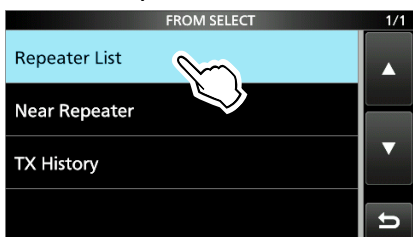

- Displays the REPEATER GROUP screen.
4. Touch the repeater group where your access repeater is listed.
 5. Touch your access repeater. (Example: Kirkland)

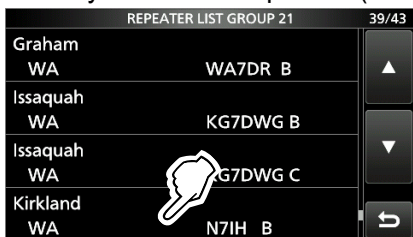

- Returns to the DR screen, and the selected repeater name is displayed in "FROM."
- ① By just selecting the repeater name, the repeater call sign, its frequency, duplex setting, and frequency offset are automatically set.
 - ① The repeater list here is just an example.

TIP: There are several ways to set the access repeater. (p. 14-1)

- Rotate **(MAIN DIAL)** on the DR screen with "FROM" is selected.
- Search for the nearest repeater.
- Set from the TX History.
- Search for a repeater using the DR scan.

Step 2: Set "TO" (Destination)

1. Touch "TO" twice.



2. Touch "Gateway CQ."

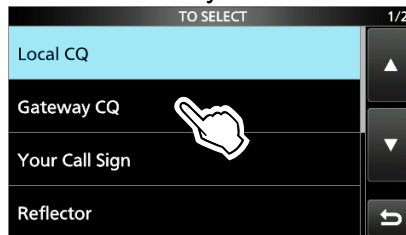

- Displays the REPEATER GROUP screen.
3. Touch the repeater group where your destination repeater is listed.
 4. Touch your destination repeater. (Example: Melbourne)



- Returns to the DR screen, and the selected repeater name is displayed in "TO."

Step 3: Check whether you can access the repeater

Hold down **[PTT]** to transmit.

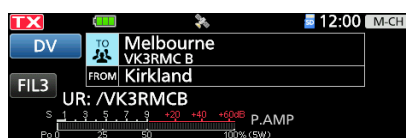

- If you get a reply call, or "UR?" is displayed within 3 seconds, your signal reached your access repeater and your call was successfully sent to your destination repeater.

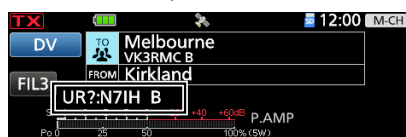

TIP: See page 13-17 for status indications after a reply is received.

Receiving

When a DV call is received, the call signs of the caller, the called station, and the called station's access repeater are saved in the RX History. Up to 50 calls can be saved.

Even if you turn OFF the transceiver, the RX History is retained.

This section describes how to display the RX History screen and how to save the call sign in Your Call Sign memory.

When receiving a call from "JM1ZLK":



The S-meter and the caller's call sign are displayed.

Step 1: To display a received call sign

Open the RX HISTORY screen.

[MENU] » **[CD]**

- Rotate **[MAIN DIAL]** to display other RX history records.

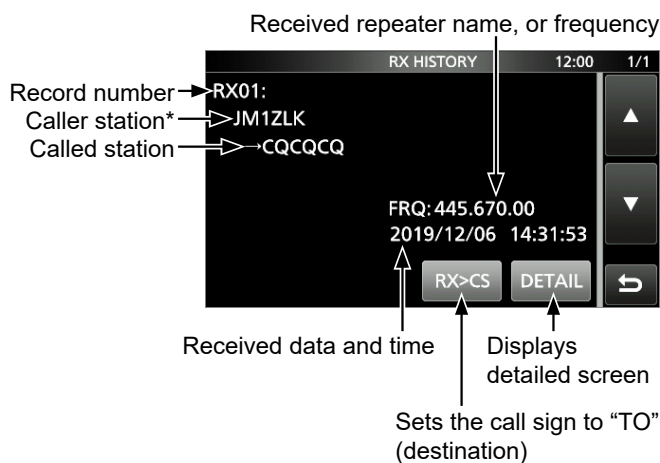

* The caller name is displayed when the name is set in the "Your Call Sign" list.

Push **[QUICK]** to switch between name display and call sign display.

- ① "/" and a note may be displayed after the call sign.
- ① If a call is received from an area, not from a specific station, "CQCQCQ" is displayed.

Step 2: Save the destination call sign into Your Call Sign memory from RX History

1. Rotate **[MAIN DIAL]** to select the RX history record with the call sign that you want to save to memory.
2. Touch **[DETAIL]**.
3. Push **[QUICK]**.
4. Touch "Add To Your Memory."

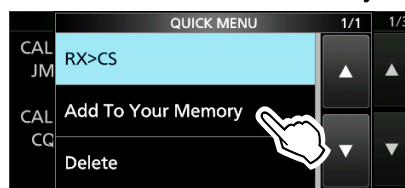

5. Touch the call sign that you want to save. (Example: "JM1ZLK")



6. Touch "NAME."
7. Enter a name of up to 16 characters, then touch **[ENT]**.

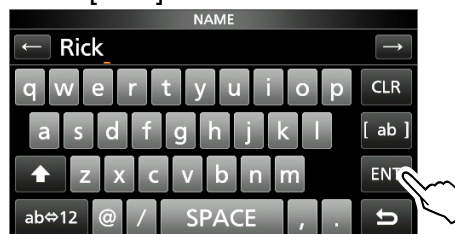

① See "Keyboard entering and editing" in the BASIC MANUAL for details.

8. Touch "<<Add Write>>."

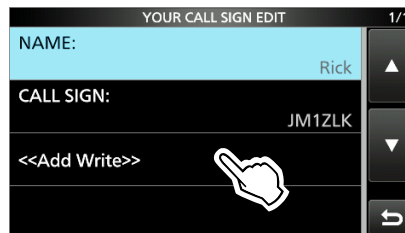

9. Touch **[YES]**.

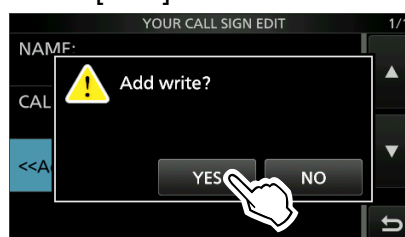

• Returns to the RX HISTORY DETAIL screen.

10. To close the RX HISTORY screen, push **[EXIT]** several times.

13. D-STAR OPERATION (BASIC)

Capturing a call sign

After you receive a signal, the calling station's call sign can be captured by holding down the Call Sign Capture key () for 1 second. After releasing, you can quickly and easily reply to the call.

What is the Call Sign Capture key?

Holding down the Call Sign Capture key for 1 second sets the last received station's call sign as a temporary destination, and makes replying quick and easy.

Step 1: Set the received call sign to "TO" (Destination)

While receiving, hold down  for 1 second.

- Announces the station call sign.



Information

- If you want to select another call sign in the RX History, push , and then rotate **(MAIN DIAL)**.
- When a received signal is weak, or during a DV scan, the call sign may not be correctly received. In that case, you cannot capture the call sign.
- When "RX>CS SPEECH" is set to "OFF," the transceiver does not announce the call sign.

MENU » **SET > Function > SPEECH > RX>CS SPEECH**

Step 2: Hold down [PTT] to transmit

1. Hold down [PTT] to transmit.

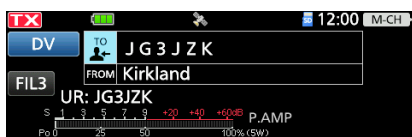

2. Release [PTT] to receive.

1. Push  to return to the previous call sign setting.

Making a Local CQ call

You can make a Local CQ call when "TO" (Destination) is set to "Local CQ."

What is a Local CQ Call?

To call a CQ through only your local area (access) repeater.

Step 1: Set "FROM" (Access repeater)

1. Same as described in page 13-6.

Step 2: Set "TO" (Destination)

1. Touch "TO" twice.



2. Touch "Local CQ."

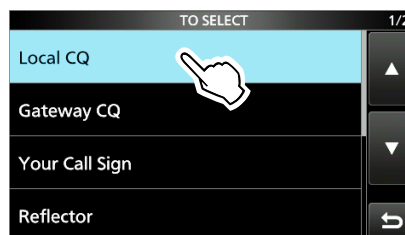

- Returns to the DR screen, and "CQCQCQ" is displayed in "TO."

Step 3: Hold down [PTT] to transmit

1. Hold down [PTT] to transmit.



2. Release [PTT] to receive.

TIP: The Local CQ call is used to call anyone, but you can call a specific station by simply saying their call sign.

13. D-STAR OPERATION (BASIC)

Making a Gateway CQ call

You can make a Gateway CQ call when a destination repeater is selected in "TO" (Destination).

What is a Gateway CQ Call?

- Calling CQ through a repeater connected to the Internet.
- You can call CQ to areas where you cannot directly access, because the communication is routed through the Internet.

Step 1: Set "FROM" (Access repeater)

① Same as described in page 13-6.

Step 2: Set "TO" (Destination)

1. Touch "TO" twice.



2. Touch "Gateway CQ."

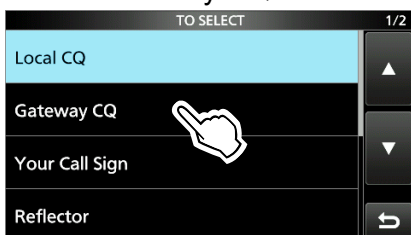

- Displays the REPEATER GROUP screen.

3. Touch the repeater group where your destination repeater is listed.

4. Touch your destination repeater. (Example: Hirano)

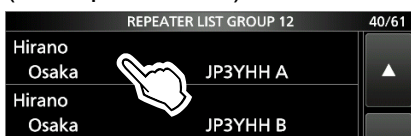

- Returns to the DR screen, and the selected repeater name is displayed in "TO."

Step 3: Hold down [PTT] to transmit

1. Hold down [PTT] to transmit.

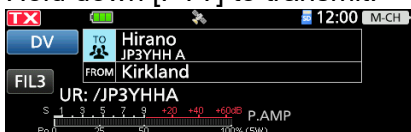

2. Release [PTT] to receive.

NOTE: If the selected Access repeater is not connected to the Internet, **XGW** is displayed. In that case, you cannot select "Gateway CQ."

Calling an individual station

You can make a call to an individual station when the station call sign is selected in "TO" (Destination). When you call an individual station through a gateway, your call is automatically sent to the last repeater that the station accessed. So, even if you don't know where the station is, you can make a call using Call Sign Routing.

Step 1: Set "FROM" (Access repeater)

① Same as described in page 13-6.

Step 2: Set "TO" (Destination)

1. Touch "TO" twice.



2. Touch "Your Call Sign."

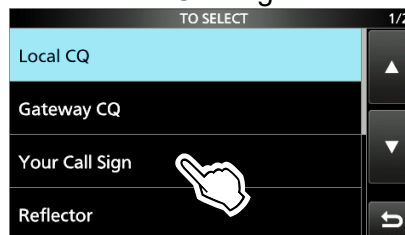

3. Touch your destination station. (Example: Rick)

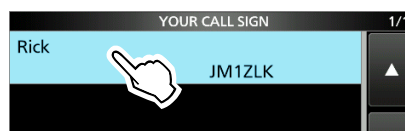

- Returns to the DR screen, and the selected name is displayed in "TO."

Step 3: Hold down [PTT] to transmit

1. Hold down [PTT] to transmit.



2. Release [PTT] to receive.

Saving to Memory channels

When “FROM” (Access repeater) and “TO” (Destination) settings are saved to a Memory channel, the settings can be selected by rotating **[MULTI]** in the Memory mode.

Step 1: Saving settings into memory

1. On the DR screen, select the “FROM” and “TO” settings to be saved into memory.
2. Push **[QUICK]**.
3. Touch “Memory Write.”

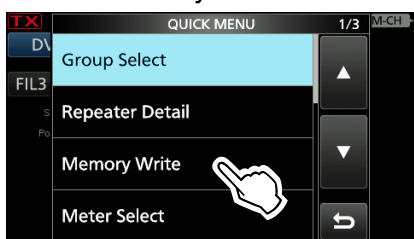

4. Touch “Write to a New Channel.”

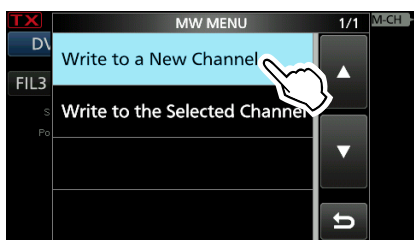

5. Touch the desired Memory channel.
(Example: channel 00 in group 00)
① To change a memory group, touch **[GROUP]**.

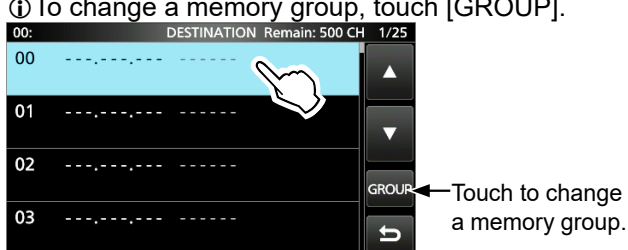

6. Touch **[YES]**.

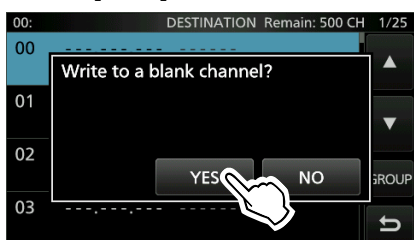

- The operating data is entered in the selected channel. “FROM” and “TO” names are automatically entered as the Memory name. (Up to 16 alphanumeric characters.)

Step 2: View the saved contents

1. Hold down **[DR]** for 1 second to cancel the DR screen.
2. Select the Memory mode.
3. Rotate **[MULTI]** to select the saved channel.
(Example: channel 00 in group 00)

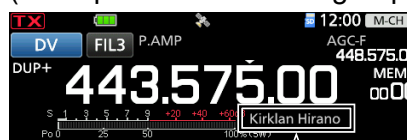

TIP: Checking the Memory contents

You can check the Memory contents on the MEMORY screen.

1. Open the MEMORY screen.
[MENU] » **[MEMORY]**
2. Touch a group that contains the Memory channel you want to check. (Example: 00)

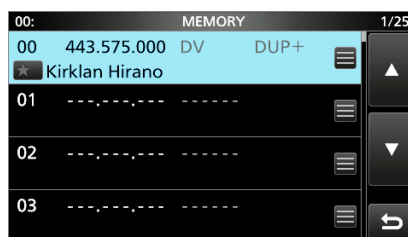
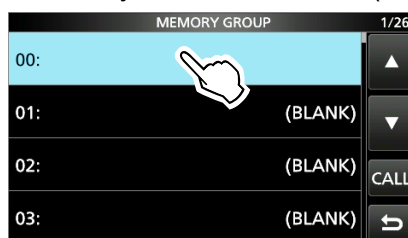

About Reflectors

◇What is a reflector?

A reflector is a special server connected to the Internet and running a version of the D-Plus software. If the D-Plus software is installed on your Access repeater, it provides various functions including gateway and reflector linking capabilities (It is known as the D-STAR reflector system). The D-STAR reflector system enables a number of D-STAR repeaters anywhere to link to a reflector. This means that when you transmit through a D-STAR repeater linked to a reflector, your voice can be heard on other repeaters linked to the reflector, and you can hear other stations that are connected to the reflector.

D-STAR reflector system

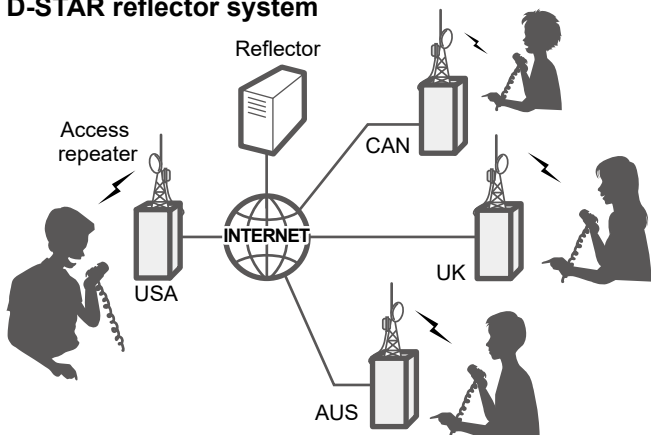

◇Unlinking a reflector

Before trying to link to another reflector, BE SURE to unlink the reflector that is currently connected to the repeater.

NOTE: If a reflector is already connected, ask on the air whether or not you can change reflectors and wait for responses. BE SURE to reconnect back to the same reflector when you finish your conversation.

1. Touch "TO" to select, and then touch "TO" again.



2. Touch "Reflector."

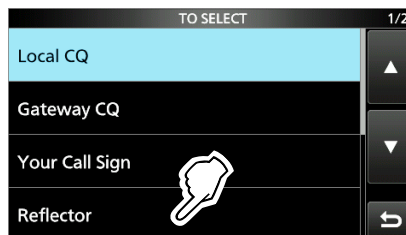

3. Touch "Unlink Reflector."



- Returns to the DR screen, and "Unlink Reflector" and "U" are displayed in "TO."



4. Hold down [PTT] to unlink the reflector.

13. D-STAR OPERATION (BASIC)

About Reflectors

◇ Linking to a reflector

If your repeater is not currently linked to a reflector, or if you want to change it to another reflector, follow the steps below. Before linking to another reflector, BE SURE to unlink any current reflector. (p. 13-11)

Direct inputting a Reflector

Example: Directly entering “REF010BL.”

1. Touch “TO” to select, and then touch “TO” again.

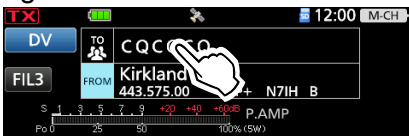

2. Touch “Reflector.”



3. Touch “Link to Reflector.”

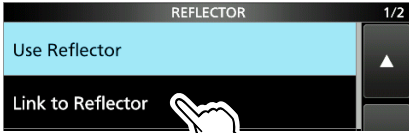

4. Touch “Direct Input.”



5. Touch [+] or [-] to select the reflector type, reflector number, and module letter, then touch [SET].

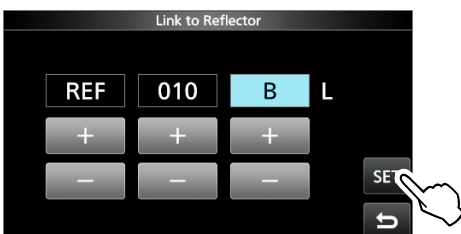

- Returns to the DR screen, and “Link to Reflector” and entered reflector is displayed in “TO.”



6. Hold down [PTT] to link to the reflector.

Direct inputting a Reflector

TX History saves up to 5 reflectors that your Access repeater linked to before.

Example: Select “REF010BL” in TX History.

1. Touch “TO” to select, and then touch “TO” again.



2. Touch “Reflector.”

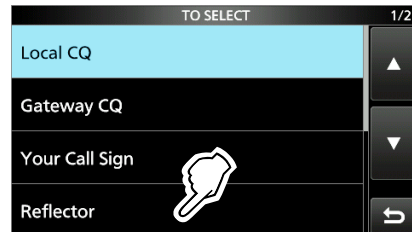

3. Touch “Link to Reflector.”

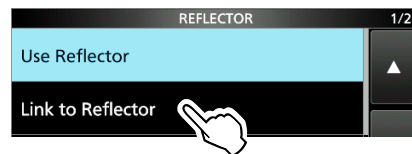

4. Touch the reflector that you want to link to.

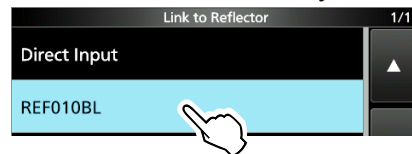

- Returns to the DR screen, and “Link to Reflector” and “REF010BL” are displayed in “TO.”



5. Hold down [PTT] to link to the reflector.

13. D-STAR OPERATION (BASIC)

About Reflectors

◇ Using a reflector

1. Touch "TO" to select, and then touch "TO" again.

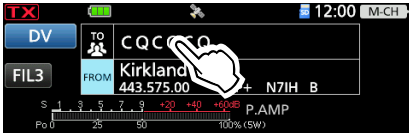

2. Touch "Reflector."



3. Touch "Use Reflector."

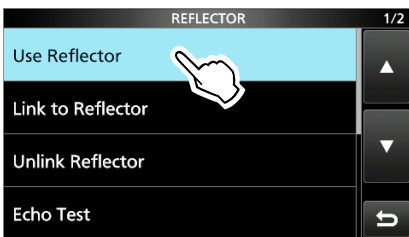

- Returns to the DR screen, and "Use Reflector" and "CQCQCQ" are displayed in "TO."

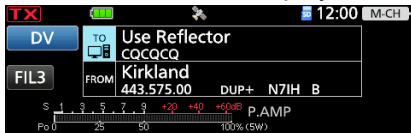

4. Hold down [PTT] to transmit.

◇ Reflector Echo Testing

To confirm that your signal is correctly getting into the repeater, you can transmit a short message as a trial. After stopping transmission, your message will be played back.

1. Touch "TO" to select, and then touch "TO" again.



2. Touch "Reflector."

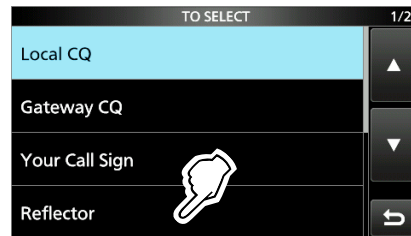

3. Touch "Echo Test."



- Returns to the DR screen, and "Echo Test" and "E" are displayed in "TO."

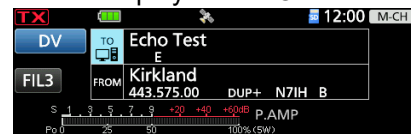

4. Hold down [PTT] and speak into the microphone.
5. Release [PTT] to hear your message.

13. D-STAR OPERATION (BASIC)

About Reflectors

◇ Requesting repeater information

When you send the repeater information command, an ID message is sent back.

1. Touch “TO” to select, and then touch “TO” again.



2. Touch “Reflector.”



3. Touch “Repeater Information.”

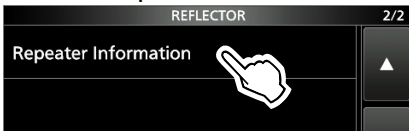

- Returns to the DR screen, and “Repeater Information” and “1” are displayed in “TO.”

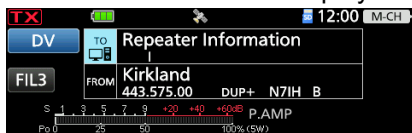

4. Hold down [PTT] to transmit the repeater Information command.
5. Release [PTT] to hear the repeater ID message.

Updating the repeater list

For easy operation, a repeater list is preloaded into your transceiver.

This section describes how to update the repeater list using a microSD card.

You can download the repeater list from the Icom website.

NOTE: Before using a microSD card, see Section 6 of the Basic Manual for card details.

TIP: The file name “705_USA_yymmdd” is used as an example in the following instructions.

File Name: 705_USA_yymmdd.zip

↑
Depending on the transceiver version.

↑
Depending on the updated file date.

Step 1: Downloading the repeater list

1. Access the following URL to download the data files.
<https://www.icomjapan.com/support/>
 - The repeater list and GPS data (CSV: Comma Separated Values file), and settings file (ICF file) are contained in the downloaded ZIP file.

TIP: IC-705’s repeater list is uploaded to “Firmware/Software” in the Icom website.

ⓘ The displayed contents may differ.

Type	Model Name	Version	last update
Repeater List, GPS Data	IC-705	Version *	20yy/mm/dd

2. Decompress the file that is downloaded from the Icom website.
 - “705_USA_yymmdd” folder is created on the same place where the downloaded file is saved.

Step 2: Inserting the microSD card into a PC

Turn OFF the transceiver, then remove the microSD card from the transceiver. Insert the card into the memory card slot or memory card reader (user supplied) on your PC.

- ① To use the microSD card with the transceiver, format the card using the transceiver, even ones that are preformatted for PCs or other uses. See Section 6 of the Basic Manual for details.

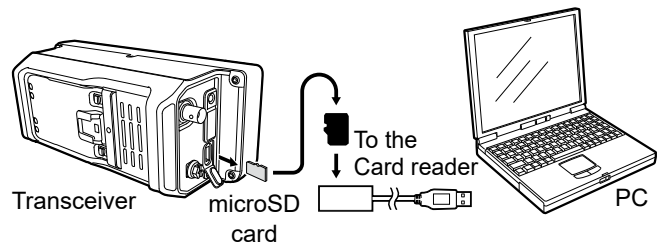

Step 3: Copying the CSV file to the microSD card

1. Double-click the “705_USA_yymmdd” folder created in the same place where the downloaded file is saved.
2. Copy the CSV file (Example: 705_USA_Rpt_yymmdd.csv) in the folder and paste it in the “RptList” folder (“IC-705” > “Csv” > “RptList”) of the microSD card.

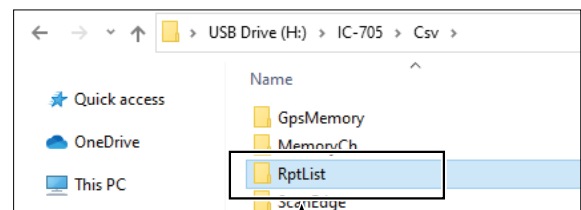
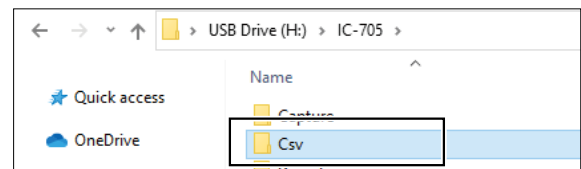
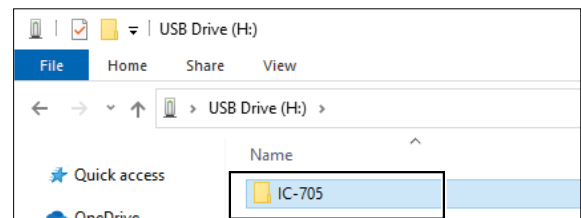

Paste the copied CSV file in this folder.

13. D-STAR OPERATION (BASIC)

Updating the repeater list

Step 4: Removing the microSD card

Turn OFF the transceiver, then remove the microSD card from your PC, and insert it into the transceiver's slot.

TIP: We recommend that you save the current data before loading other data into the transceiver.

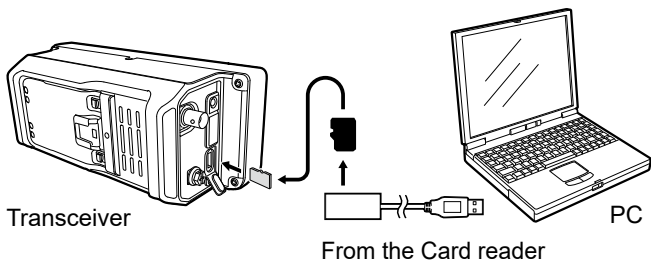

Step 5: Updating the repeater list

1. Open the IMPORT/EXPORT screen.
MENU » **SET > SD Card > Import/Export**

2. Touch "Import."



3. Touch "Repeater List."

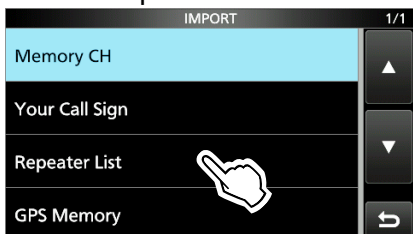

4. Touch the CSV file to import.
(Example: 705_USA_Rpt_yymmdd)



5. Touch [YES] or [NO].

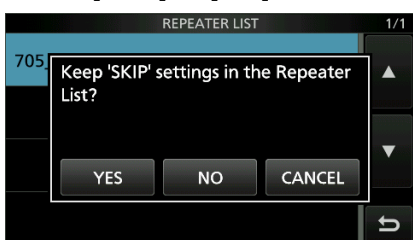

- YES: Retains the Skip settings of the repeater list. (p. 14-31)
- NO: Does not retain the Skip settings of the repeater list.

6. Touch [YES].

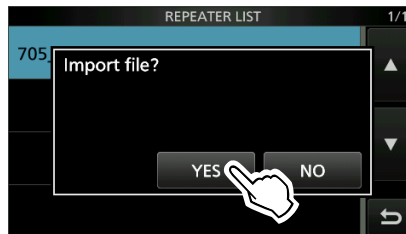

- After the importing ends, "COMPLETED! Restart the IC-705." is displayed.

7. Turn the OFF transceiver power, then turn it ON again to restart the transceiver.

TIP: If you copy the ICF file to the "Setting" folder of the microSD card, the repeater list can be updated with the same procedures. In that case, touch "Load Setting" on the SD CARD screen. And on the LOAD FILE screen, touch "Repeater List Only."

MENU » **SET > SD Card > Load Setting**

13. D-STAR OPERATION (BASIC)

When receiving no reply

To communicate through a repeater, your signal must access the repeater. The following chart is designed to help you correct problems which are not equipment malfunctions.

Problem	Possible Cause	Solution	REF.
After your call, the repeater does not return a status reply.	A repeater settings are incorrect.	Select the correct repeater.	p. 13-6
		Correct the repeater frequency, frequency offset, or duplex settings.	–
	Your transmission did not reach the repeater.	Wait until you are closer to the repeater and try again.	–
		Try to access another repeater.	–
After your call, 'UR?' and its call sign are displayed.	The call was successfully sent, but no station immediately replied.	Wait for a while, and try again.	–
After your call, 'RX' or 'RPT?' and the access repeater's call sign are displayed.	Your own call sign (MY) has not been set.	Set your own call sign (MY).	p. 13-3
	Your own call sign (MY) has not been registered on a gateway repeater, or the registered contents do not match your transceiver's settings.	Register your own call sign (MY) on a gateway repeater, or confirm the registration of the call sign.	p. 13-4
After your call, 'RPT?' and the access repeater's call sign are displayed.	The call sign of the destination repeater is incorrect.	Correctly set the destination repeater's call sign.	–
After your call, 'RPT?' and the destination repeater's call sign are displayed.	The repeater cannot connect to the destination repeater.	Check the repeater settings.	–
	The repeater is busy.	Wait for a while, and try it again.	–
Even when holding down DR , the DR screen is not displayed.	There is no repeater list in your transceiver.	Import the list using a microSD card.	p. 13-15
		Directly enter the Repeater list data into the transceiver.	p. 14-23
	The Lock function is activated.	Hold down SPEECH for 1 second to turn OFF the Lock function.	–
Even when you push AUTOTUNE (RX-CS) , the received call sign will not be set to the destination call sign.	The call sign has not been correctly received.	Try it again, after the transceiver has correctly received the call sign.	–
	When a weak signal is received, or a signal is received during scanning, the call sign may not be received correctly. In that case, "-----" is displayed and error beeps sound, and a reply call cannot be made.		
A Local area call can be made, but a Gateway call, or destination station call, cannot be made.	MY call sign has not been registered.	Register your own call sign (MY) on a gateway repeater, or confirm the registration of the call sign.	p. 13-4
	The repeater set in "FROM" (Access Repeater) has no Gateway.	Check the repeater settings.	p. 13-4
"L" is displayed.	While receiving through the Internet, some packets may be lost due to a network error (or poor data throughput performance).	Wait a while, and try it again. When the transceiver receives corrupted data, and misidentifies it as packet loss, "L" is displayed, even if it is a Local area call.	–
"DV" and "FM" icons alternately blink.	While in the DV mode, an FM signal is received.	Use a different operating frequency until there are no FM signals on the original frequency.	p. 14-16

14. D-STAR OPERATION (ADVANCED)

“FROM” (Access repeater) setting

Your Access repeater must be set in “FROM” when you make a call on the DR screen. You have 5 ways to select the Access repeater.

By rotating **MAIN DIAL**

Select the preset repeater on the DR screen by touching “FROM” and then rotating **MAIN DIAL**.

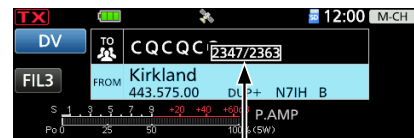

Displayed while rotating **MAIN DIAL**.

When you know your access repeater:

From the repeater list (p. 14-2)

When your access repeater is in your transceiver’s repeater list, you can select it by selecting the repeater area and name, if entered, or call sign.

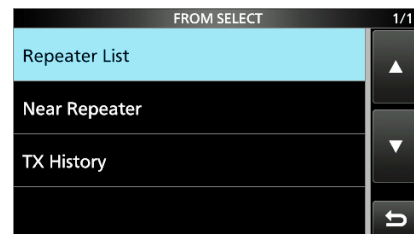

When you do not know which repeater you can access:

Search for a repeater using the DR scan (p. 14-3)

The Normal DR scan searches for output repeater frequencies or simplex signals.

You can also find FM repeaters.

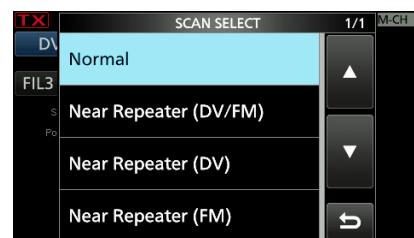

Search for the nearest repeater (p. 14-4)

The Near Repeater scans for the nearest repeater by using your location and the repeater’s location, if it is entered in the Repeater List.

The nearest repeaters in your transceiver’s Repeater List are displayed as selectable choices.

You can select a nearby DV or FM repeater type.

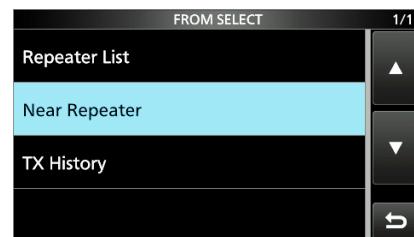

When the “FROM” data is saved in the TX History:

Select from the TX History (p. 14-5)

Select a repeater that you have accessed before, from the TX History record.

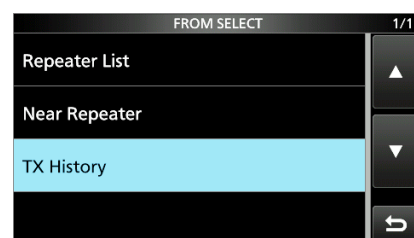

14. D-STAR OPERATION (ADVANCED)

“FROM” (Access repeater) setting

◇ Using your transceiver’s repeater list

When your access repeater is in your transceiver’s repeater list, you can select it from the list. By just selecting the repeater from the list, the repeater call sign, its frequency, duplex setting, and frequency offset are automatically set, for easy operation.

Example: Selecting the “Kirkland” repeater in Washington state in the USA from the repeater list.

1. Hold down **DR** for 1 second to display the DR screen.
2. Touch “FROM” to select, and then touch “FROM” again.



3. Touch “Repeater List.”

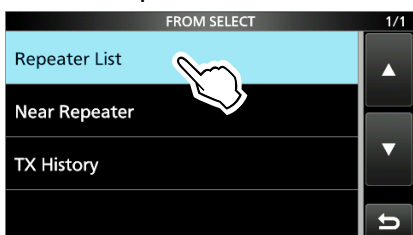

- Displays the REPEATER GROUP screen.

4. Touch the repeater group where your access repeater is listed.
5. Touch your access repeater. (Example: Kirkland)



- Returns to the DR screen, and the selected repeater name is displayed in “FROM.”
- ① By just selecting the repeater name, the repeater call sign, its frequency, duplex setting, and frequency offset are automatically set.

TIP:

When you select an FM repeater:

When an FM repeater is in your transceiver’s repeater list, you can select it from the list. When selecting an FM repeater, the “TO” setting is not necessary, and a “---” is displayed in “TO.”

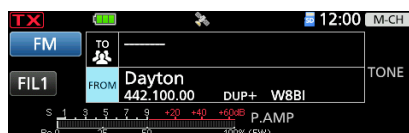

When selecting an FM repeater.

How to change the repeater group:

To change the repeater group on the DR screen, push **QUICK**, then touch “Group Select.”

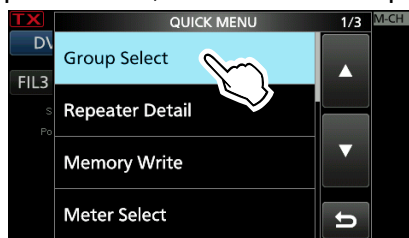

14. D-STAR OPERATION (ADVANCED)

“FROM” (Access repeater) setting

◇ Using the DR scan

The DR scan scans frequencies to find a signal on a repeater, or on a simplex frequency. You can use 2 kinds of DR scans, Normal scan and Near Repeater scan.

Normal scan

To quickly find a repeater, the Normal scan skips repeaters that are not set as an access repeater.

① The “USE (FROM)” setting is set to “NO” on the repeater list.

MENU » **DV MEMORY > Repeater List**

Near Repeater scan

The Near Repeater scan searches for up to 20 nearby repeaters by using your position data and the repeater’s entered position data, and then lists the repeaters.

① The Near Repeater scan continues, even if you turn OFF the transceiver, and then turn it ON again during the scan.

② If your own position data is not being received from GPS satellites, the last received position data is used.

NOTE: Even if your transceiver receives a repeater signal, the repeater may not receive your signal, because the repeater’s output power is higher than your transceiver’s, and your signal does not reach the repeater.

TIP: The DR scan scans the simplex frequencies in the repeater list, in addition to D-STAR repeaters.

Example: Selecting an active repeater using the DR scan.

1. Hold down **DR** for 1 second to display the DR screen.
2. Touch “FROM” to select.



3. Push **SCAN**.
 - Displays the SCAN SELECT screen.
 4. Touch the scan type.
 - Normal:
 - Searches for repeaters whose “USE (FROM)” setting is set to “YES.”
 - Near Repeater (DV/FM):
 - Searches for up to 20 each of nearby DV or FM repeaters. (Total 40 repeaters)
 - Near Repeater (DV):
 - Searches for up to 20 nearby DV repeaters.
 - Near Repeater (FM):
 - Searches for up to 20 nearby FM repeaters.
 - The selected scan starts.
 - In the DR scan, the repeaters are sequentially displayed by distance, in descending order.
- ① The scan resumes the same as other scans.

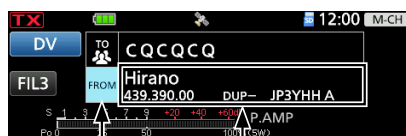

Blinks The repeaters are sequentially displayed.

5. When the transceiver receives a signal from a repeater, the scan stops. Push **SCAN**.

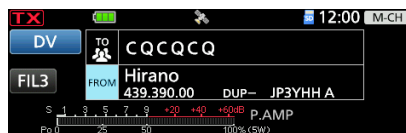

- The DR scan is canceled, and the repeater is set to “FROM.”

14. D-STAR OPERATION (ADVANCED)

“FROM” (Access repeater) setting

◇ Using the Near Repeater Search function

The transceiver searches for the nearest repeaters by using your location and the repeater’s entered position data.

The nearest repeaters in your transceiver’s repeater list are displayed as selectable options.

NOTE:

- When using the Near Repeater Search function, BE SURE to first receive your own GPS position data, or manually enter your position data.
- If no repeater is found within a 160 kilometer (100 miles) range, “No Repeater Found” is displayed.
- If the last received position data can be used, “GPS is invalid. Search by last valid position” is displayed.

Example: Selecting a nearby repeater from the Near Repeater list.

Step 1. Receiving your own location from the GPS satellite

Confirm the GPS receiver is receiving the satellite signals.

The GPS icon blinks when searching for satellites.



The GPS icon stops blinking when the minimum needed number of satellites are found.



① It may take only a few seconds to receive, or it may take a few minutes, depending on your operating environment. If you have difficulties receiving, we recommend that you try a different location.

① When “GPS Select” is set to “Manual,” the icon is not displayed.

MENU » **GPS > GPS Set > GPS Select**

① If your own location is not being received, the last received position is used for your location.

Step 2. Selecting the Access repeater from the Near Repeater list

1. Hold down **DR** for 1 second to display the DR screen.
2. Touch “FROM” to select, and then touch “FROM” again.



3. Touch “Near Repeater.”
 - Displays the NEAR REPEATER screen.
4. Touch the type of nearby repeater to display.
 - Near Repeater (ALL): Displays up to 20 nearby each of DV and FM repeaters. (A total 40 repeaters)
 - Near Repeater (DV): Displays up to 20 nearby DV repeaters.
 - Near Repeater (FM): Displays up to 20 nearby FM repeaters.
5. Touch the repeater to use as your access repeater, considering the distance from your location to the repeater.

Repeater call sign

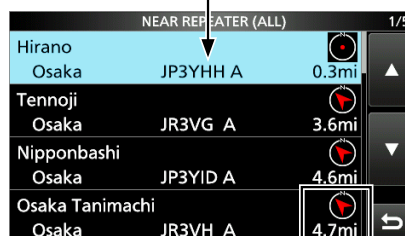

Distance and direction* from your location to the repeater

① “FM” is displayed for FM repeaters.

* When “POSITION” (p. 14-27) is set to “Approximate” on the repeater list, the direction data is not displayed if the distance to the repeater is less than 5 kilometers.

MENU » **DV MEMORY > Repeater List**

- Returns to the DR screen, and the selected repeater is set to “FROM.”

14. D-STAR OPERATION (ADVANCED)

“FROM” (Access repeater) setting

◇ Using TX History

The TX History saves up to 10 of the latest Access (From) repeaters you transmitted on. You can select a repeater from TX History as your Access repeater.

Example: Selecting the “Hirano” repeater from TX History.

1. Hold down **DR** for 1 second to display the DR screen.
2. Touch “FROM” to select, and then touch “FROM” again.



3. Touch “TX History.”
 - Displays the TX HISTORY screen.
4. Touch the TX History type.
(Example: TX History (DV))



- TX History (DV):
Displays the TX History of the DV repeaters.
 - TX History (FM):
Displays the TX History of the FM repeaters.
5. Touch the repeater to use it as your Access repeater.

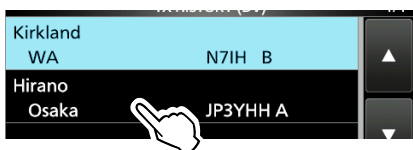

- Returns to the DR screen, and the selected repeater is set to “FROM.”

TIP: When you touch the repeater for 1 second in step 5, you can display the REPEATER DETAIL screen, or delete the repeater information from the TX HISTORY screen.

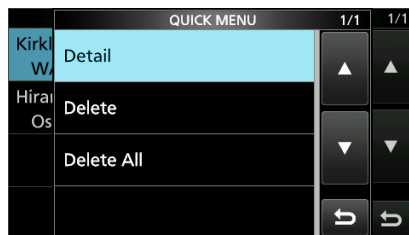

“TO” (Destination) setting

“CQCQCQ,” a destination repeater, or a station call sign must be set in “TO” when you make a call in the DV mode. You have 8 ways to set “TO” (destination).

By rotating **(MAIN DIAL)**

Select the repeater or Your Call Sign that is displayed by rotating **(MAIN DIAL)** on the DR screen. (This operation is disabled when “CQCQCQ” is set.)

TIP: After you receive the individual station or repeater’s signal, the call sign can be captured by holding down the Call Sign Capture key **(AUTOTUNE (RX-CS))**, and you can quickly and easily reply to a call.

To make a Local Area CQ call:

Set “CQCQCQ” in “TO” (Destination). (p. 14-7)

To make a Gateway CQ call:

Select a repeater from the repeater list, if you want to make a Gateway call. (p. 14-7)

To make a call to a specific station:

Select the station call sign in the Your Call Sign list. (p. 14-7)

To make a call through a reflector:

Select a reflector that is connected to the repeater you want to call through. (p. 13-11)

To select from RX History:

When you receive a call, the caller station data is saved in RX History. You can select the destination from the record. (p. 14-8)

To select from TX History:

When you make a call, the destination repeater or called station data is saved in TX History. You can select the destination from the record. (p. 14-8)

To directly enter the destination station call sign:

Directly enter the destination station’s call sign. (p. 14-9)

To directly enter the destination repeater call sign:

Directly enter the destination repeater’s call sign. (p. 14-9)

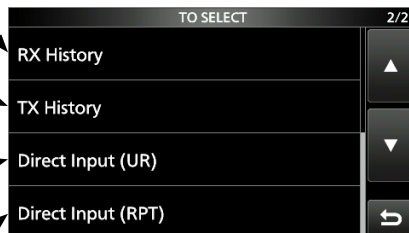
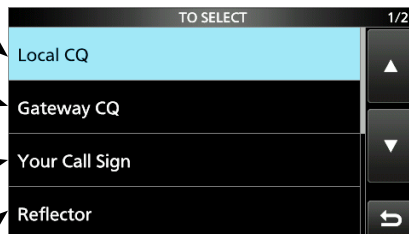

14. D-STAR OPERATION (ADVANCED)

“TO” (Destination) setting

◇ Making a “Local CQ” (Local Area) call

When “Local CQ” is selected on the TO SELECT screen, “CQCQCQ” is set in “TO.”

Example: Making a Local area call by accessing the “Kirkland” repeater.

1. Touch “TO” to select, and then touch “TO” again.

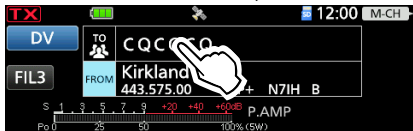

2. Touch “Local CQ.”



- Returns to the DR screen, and “CQCQCQ” is displayed in “TO.”

◇ Making a “Gateway CQ” (Gateway) call

When “Gateway CQ” is selected on the TO SELECT screen, you can select the repeater from the repeater list to make a gateway call.

Example: Making a Gateway CQ call to the “Hirano” repeater from the “Kirkland” repeater.

1. Touch “TO” to select, and then touch “TO” again.

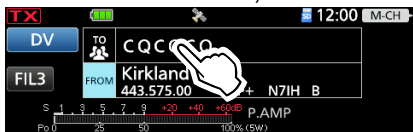

2. Touch “Gateway CQ.”
 - Displays the REPEATER GROUP screen.
3. Touch the repeater group where your destination repeater is listed.
4. Touch your destination repeater. (Example: Hirano)



- Returns to the DR screen, and the selected repeater name is displayed in “TO.”

◇ Using “Your Call Sign”

The “Your Call Sign” memory saves individual or repeater station call signs. When you select the call sign for the “TO” (Destination) setting, you can make a Gateway call. When you call an individual station through a gateway, the signal is automatically sent to the last repeater that the individual station accessed.

Therefore, even if you do not know where the individual station is located, you can make a call.

NOTE: If the repeater, set in “FROM” (Access repeater) has no Gateway call sign, you cannot make a gateway call.

Example: Selecting “Rick” from “Your Call Sign.”

1. Touch “TO” to select, and then touch “TO” again.



2. Touch “Your Call Sign.”
 - Displays the YOUR CALL SIGN screen.
3. Touch your destination station. (Example: Rick)

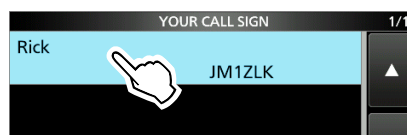

- Returns to the DR screen, and the selected name is displayed in “TO.”

TIP: After selecting a destination repeater or station, you can select another repeater or station preset in your transceiver by rotating (MAIN DIAL).

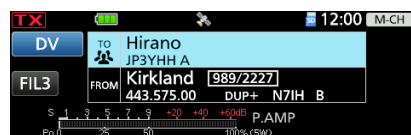

14. D-STAR OPERATION (ADVANCED)

“TO” (Destination) setting

◇ Using RX History

When a call is received in the DV mode, the call data is saved in the RX History.

Up to 50 callers, and only the last called call signs, for a total of 51 histories can be saved.

Example: Selecting “Rick” in the RX History.

1. Touch “TO” to select, and then touch “TO” again.



2. Touch “RX History.”

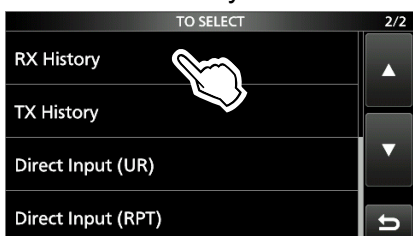

- Displays the RX HISTORY screen.

3. Touch a destination name or call sign.
(Example: Rick)



- Returns to the DR screen, and the selected name is displayed in “TO.”

TIP: To add RX HISTORY data to a “Your Call Sign” memory, push **QUICK**, then touch “Add To Your Memory.”

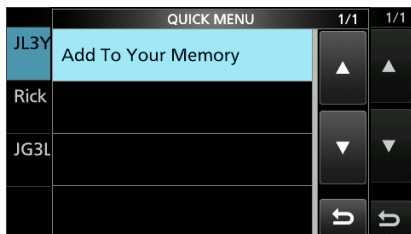

◇ Using TX History

TX History saves the repeater and station name and call sign of up to 20 “TO” (Destination) settings that were used when you made the calls.

NOTE: Until you make a call in the DV mode, you cannot select “TO” (destination) from the TX History.

Example: Selecting the “Hirano” repeater in the TX History

1. Touch “TO” to select, and then touch “TO” again.



2. Touch “TX History.”

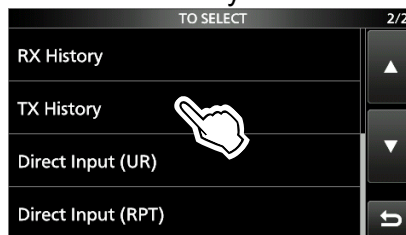

- Displays the TX HISTORY screen.

3. Touch a destination repeater.



- Returns to the DR screen, and the selected repeater name is displayed in “TO.”

TIP: You can add the TX HISTORY data to memory, or delete it from the TX HISTORY screen.

Push **QUICK**, then touch the option.

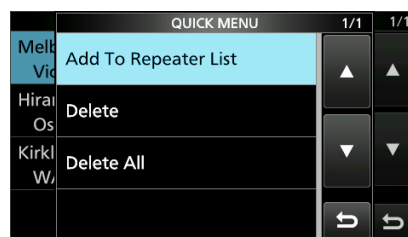

14. D-STAR OPERATION (ADVANCED)

“TO” (Destination) setting

◇ Directly entering (UR)

The destination station call sign can be directly entered.

Example: Directly entering the call sign “JM1ZLK.”

1. Touch “TO” to select, and then touch “TO” again.

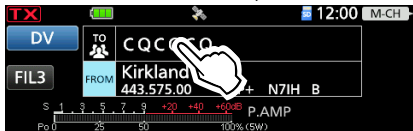

2. Touch “Direct Input (UR).”

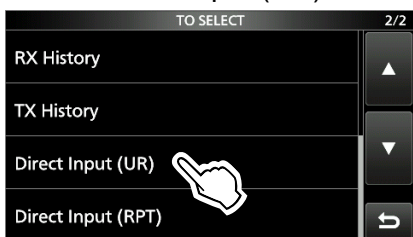

- Displays the DIRECT INPUT (UR) screen.

3. Enter the station’s call sign of up to 8 characters, including spaces.

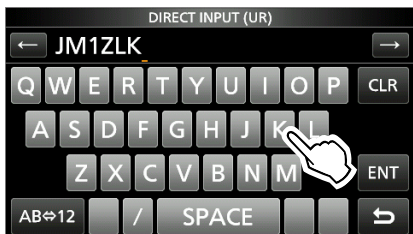

4. After entering, touch [ENT].
 - Returns to the DR screen, and the entered call sign is displayed in “TO.”
 - ① After entry, you can edit the call sign in the DIRECT INPUT (UR) screen.
 - ① The entered call sign remains on the DIRECT INPUT (UR) screen, until you enter a new call sign.

TIP: If the entered call sign has a duplicate in the “Your Call Sign” memory, the name is displayed. (Only when the name has been entered.)

◇ Directly entering (RPT)

The destination repeater call sign can be directly entered.

NOTE: BE SURE to include the node letter as the 8th digit. See page 13-5 “IMPORTANT!” about the node letters.

Example: Directly entering the call sign “JP3YDH A.”

1. Touch “TO” to select, and then touch “TO” again.

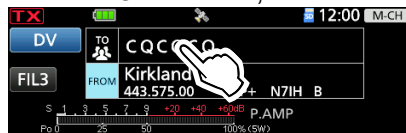

2. Touch “Direct Input (RPT).”

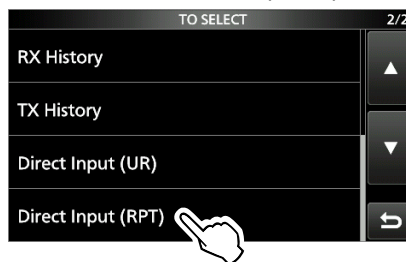

- Displays the DIRECT INPUT (RPT) screen.

3. Enter a repeater call sign of up to 8 characters, including spaces.
(Example: Hirano)



- Returns to the DR screen, and the selected repeater name is displayed in “TO.”
- ① After entry, you can edit the call sign in the DIRECT INPUT (RPT) screen.
- ① The entered call sign remains on the DIRECT INPUT (RPT) screen, until you enter a new call sign.

TIP:

- If the entered call sign has a duplicate in the repeater list, the name is displayed. (Only when the name has been entered.)
- When directly entering the repeater call sign, including a “/” at the beginning is also correct.

REPEATER DETAIL screen

Depending on the content, such as position data or UTC offset, the distance between your location and the repeater or the repeater time can be displayed on the REPEATER DETAIL screen. The detail screen can also be entered from the FROM SELECT screen.

Example: Displaying the “Hirano” repeater detail screen.

1. Touch “TO” to select, and then touch “TO” again.



2. Touch “Gateway CQ.”
3. Touch “12: Japan.”
4. Touch “Hirano” for 1 second.
5. Touch “Detail.”

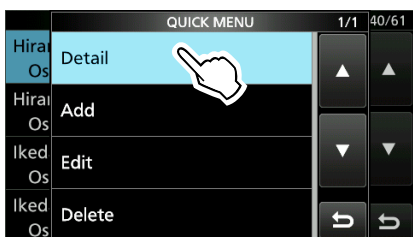

- Displays the REPEATER DETAIL screen.

6. To close the REPEATER DETAIL screen, push **EXIT**.

The REPEATER DETAIL screen

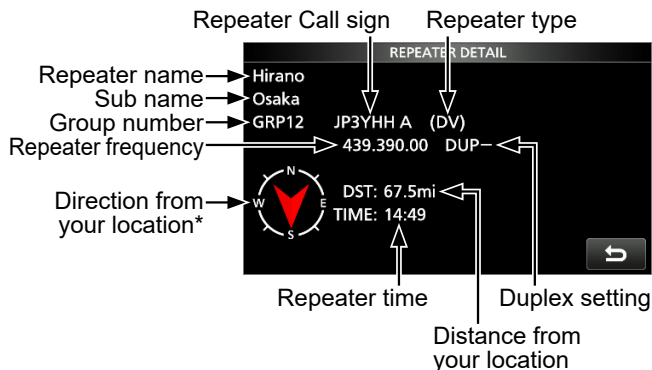

- ① If there is no position data, the distance and direction from your location are not displayed. See page 14-4 to confirm your location.
- ① When selecting an FM repeater, the tone setting is displayed.

* When “POSITION” (p. 14-27) is set to “Approximate” on the repeater list, the direction data is not displayed if the distance to the repeater is less than 5 kilometers.

TIP: You can display the REPEATER DETAIL screen when the DR screen is displayed. When you set the repeater as shown below, touch the repeater for 1 second, and then touch “Repeater Detail.”

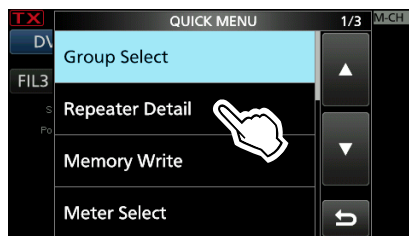

Message operation

You can save up to 5 short messages in the transceiver's memory to transmit in the DV mode. Each message can be up to 20 characters.

◇ Entering a TX message

Example: Entering "JAPAN TOM" into TX message memory number 1.

1. Open the TX MESSAGE screen.
[MENU] » **SET > My Station > TX Message**
2. Touch a TX message memory number for 1 second.

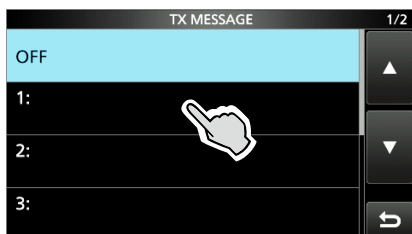

3. Touch "Edit."

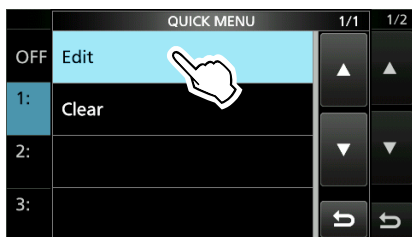

4. Enter a message of up to 20 characters, then touch [ENT].

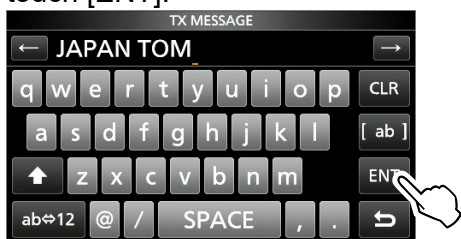

5. To close the TX MESSAGE screen, push **[EXIT]**.

◇ Transmitting a message

You can transmit a preset TX message by pushing [PTT] in the DV mode. First, select a TX message which also turns ON the Message Transmission function.

1. Open the TX MESSAGE screen.
[MENU] » **SET > My Station > TX Message**
2. Touch a TX message memory number.

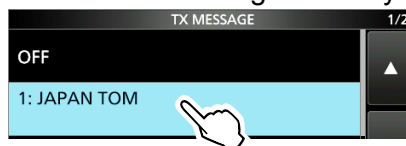

① To not transmit any message, touch "OFF."

3. To close the TX MESSAGE screen, push **[EXIT]**.

① Information

- The message is transmitted with your voice signal.
- The message is transmitted each time you transmit.
- When continuously transmitting, the selected TX message is transmitted every 30 seconds.

◇ Deleting a TX message

You can delete the TX messages.

Example: Deleting TX message "JAPAN TOM" from TX message memory number 1.

1. Open the TX MESSAGE screen.
[MENU] » **SET > My Station > TX Message**
2. Touch a TX message memory number for 1 second.

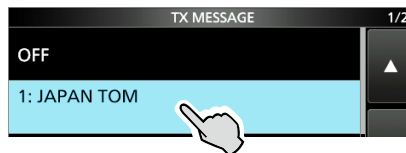

3. Touch "Clear."



- The confirmation dialog is displayed.

4. Touch [YES].
 - Clears the entered message.
5. To close the TX MESSAGE screen, push **[EXIT]**.

14. D-STAR OPERATION (ADVANCED)

Viewing received call signs

When you receive a DV call, the calling station and the repeater call signs are saved. Up to 50 calls can be saved. When you receive the 51st call, the oldest call history is deleted.

◇ Viewing the call signs on the RX History screen

1. Open the RX HISTORY screen.
MENU » **② > CD**
2. Touch an RX history memory to view the details.

① Information

- The RX history number, the caller's name (or call sign), destination, RX message, RX date and time, "GW," and "GPS" are displayed.
- "GW" is displayed when a Gateway call is received.
- "GPS" is displayed when the received call includes position data.
- "UP" is displayed when a repeater uplink signal is received.
- In the QUICK MENU screen, you can select the following options.

- RX>CS:** Temporarily enters the received call sign into "TO."
- Call Sign Display:** The received data is displayed in the Call Sign Display mode.
- Name Display:** The received data is displayed in the Name Display mode.
- Add to RPT List:** Adds the repeater's call sign to the Repeater List.
- Add to Your Memory:** Adds the caller station's call sign to Your Call Sign.
- Delete:** Deletes the selected RX history.

RX HISTORY screen (RX01)

Caller station*2
 ① A note may be displayed after "/".

History number → RX01: JM1ZLK /705

Called station → CQCQCQ
 CQCQCQ D-STAR

Displayed when a Gateway call is received. → GW

Displayed when a Gateway call is received. → GPS

Repeater name of the called station → RPT: Hirano

Received date and time → 2020/05/08 1:05:50

D-PRS information
 • Compass direction
 • Distance
 • D-PRS symbol

- D-PRS information
- Compass direction
 - Distance
 - D-PRS symbol

*1 The icon differs, depending on the D-PRS TX format.
 GPS: Position OBJ: Object
 ITEM: Item WX: Weather

*2 When a name is not entered in the DV Memory, the call sign is displayed.

3. Touch [DETAIL].
 - Displays the RX history detail screen.
 - Rotate **(MAIN DIAL)** to select the page.

<1st page>

- CALLER: Displays the caller station's name*2 and any note entered after the call sign.
- CALLED: Displays the called station's name*2.
 - ① "CQCQCQ" is displayed when receiving a Local Area call or Gateway call.



<2nd page>

- RXRPT1: Displays the repeater's name*2 that was accessed by the caller station. If the received call was a Gateway call, this item displays the gateway call sign of the repeater you received the call from.
- RX RPT2: Displays the repeater's name*2 you received the call from.

① The operating frequency is displayed instead of the above items when the call was not through a repeater (Simplex call).



14. D-STAR OPERATION (ADVANCED)

Viewing received call signs

◇ View the call signs on the RX History screen

<3rd page>

- **RX MESSAGE:** Displays any message included in the received call, if entered.
- **RX TIME:** Displays the date and time the call was received.



<4th, 5th page>

Displays position data of the caller station. If a received signal has no data, no position data is displayed.



4. To close the RX HISTORY screen, push **EXIT**.

TIP: To delete RX HISTORY data

On the RX HISTORY or the detail screen, push **QUICK**, then touch "Delete" or "Delete All."

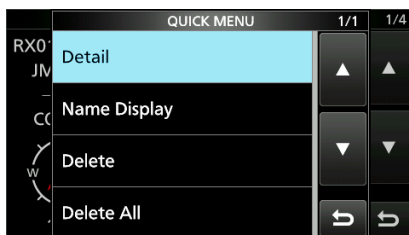

TIP: "RX RPT1" setting may differ, depending on the way the call was made.

Example 1: When a Local area call is received.

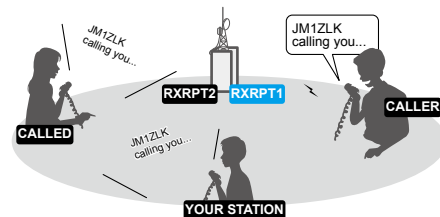

Example 2: When a Gateway call is received.

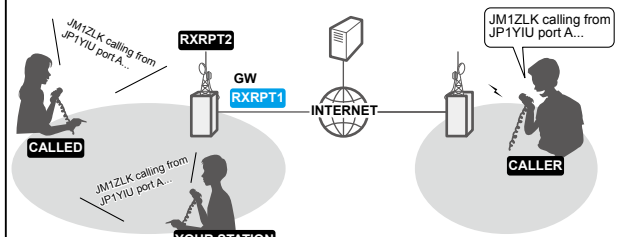

14. D-STAR OPERATION (ADVANCED)

BK mode communication

The Break-in (BK) function enables you to break into a conversation, where the 2 stations are communicating with call sign squelch (DSQL) enabled.

- ① The BK function is automatically turned OFF when you turn OFF the transceiver.
- ② This function can be used in the DV mode.

1. While 2 stations are communicating in the DV mode, touch **AUTOTUNE (RX-CS)** for 1 second.

- After releasing **AUTOTUNE (RX-CS)**, the calling station's call sign or the repeater's call sign is set to "TO" (Destination).
- Beeps sound, and the calling station's call sign is announced.

③ When a call sign is not received correctly, error beeps sound, and no call sign is set.

2. Open the BK screen.

MENU » **SET > DV SET > BK**

3. Touch "ON."

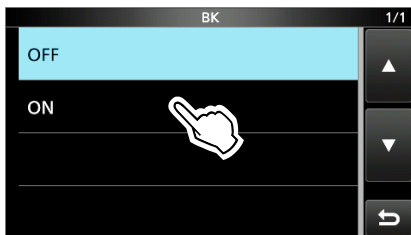

4. To close the DV SET screen, push **EXIT** several times.

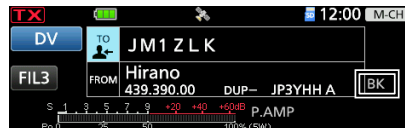

- Returns to the standby screen, and "BK" is displayed.

5. When both stations are in standby, hold down **[PTT]** to transmit.

④ "BK" blinks when receiving a Break-in call.

⑤ To cancel the BK mode, touch "OFF" in step 3, or turn OFF the transceiver.

How to use Break-in?

While using the Digital Call Sign squelch (DSQL), the squelch never opens (no audio is heard) even if a call is received, unless the call is addressed to your own call sign.

However, when a call including the "BK ON" signal (break-in call) is received, the squelch opens and audio is heard even if the call is addressed to another station.

Station C calling to Station A with "BK OFF"

Station A and B are communicating using the Digital Call Sign squelch.

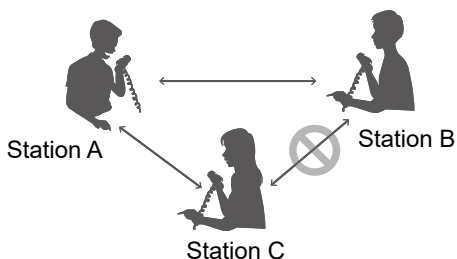

Station B does not hear that Station C is calling Station A.

Station C calling to Station A with "BK ON"

Station A and B are communicating using the Digital Call Sign squelch.

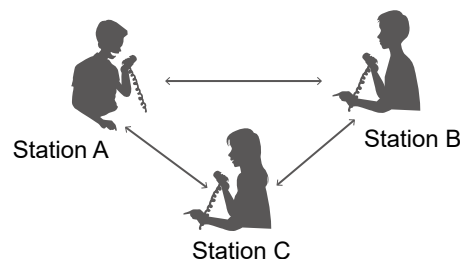

Station B also hears that Station C is calling Station A.

14. D-STAR OPERATION (ADVANCED)

EMR communication

The Enhanced Monitor Request (EMR) communication function can be used in only the DV mode. Using the EMR function, no call sign setting is necessary.

① Information

- All transceivers that can receive an EMR signal automatically open their digital squelch to receive the signal. **DO NOT** use this function except in the case of emergency.
- When an EMR signal is received, the audio (voice) is heard at the set level, even if the volume setting level is set to the minimum level.
- The EMR communication function is automatically turned OFF when you turn OFF the transceiver.

Example: Transmitting from the “Hirano” repeater using the EMR function.

1. Open the EMR screen.

MENU » **SET > DV SET > EMR**

2. Touch “ON.”

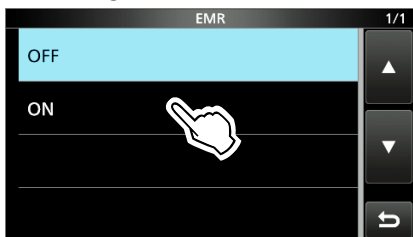

3. To close the DV SET screen, push **EXIT** several times.



- Returns to the standby screen, and “EMR” is displayed.
4. Hold down [PTT] to transmit.
 - ① “EMR” blinks on a station that receives the EMR signal. The audio (voice) is heard at the set EMR AF Level, or the **(AF/RF/SQL)** control level, whichever is higher.
 - ① To cancel the EMR mode, touch “OFF” in step 2, or turn OFF the transceiver.

◇ Adjusting the EMR AF level

The audio output level, when an EMR signal is received, is adjustable between 0 and 100%. When an EMR signal is received, the audio is heard at the preset level, or the **(AF/RF/SQL)** control level, whichever is higher. To turn OFF the setting, set to “0.”

1. Open the “EMR AF Level” screen.

MENU » **SET > DV SET > EMR AF Level**

2. Touch [+] or [-] to adjust the EMR audio output level between 0% (OFF) and 100% (maximum). (Default: 50%)

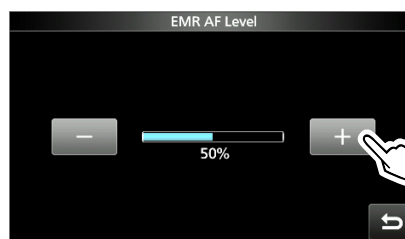

3. To close the “EMR AF Level” screen, push **EXIT** several times.

14. D-STAR OPERATION (ADVANCED)

Automatic DV detection

If you receive an FM signal while in the DV mode, the “DV” and “FM” icons alternately blink to indicate the received signal is FM. When the DV Auto Detect function is ON, the transceiver automatically selects the FM mode to temporarily monitor the signal. (Default: OFF)

① Regardless of this setting, the “DV” and “FM” icons alternately blink if you receive an FM signal while in the DV mode.

NOTE: When Digital Call Sign squelch (DSQL) or Digital Code squelch (CSQL) is selected, the transceiver does not receive FM signals, even if this function is ON. You can silently wait for calls from others.

1. Open the “DV Auto Detect” screen.
MENU » **SET > DV SET > DV Auto Detect**
2. Touch “ON.”

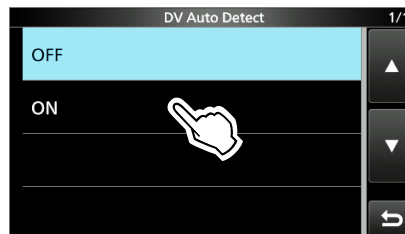

3. To close the DV SET screen, push **EXIT** several times.
 ① When an FM signal is received while in the DV mode, the “DV” and “FM” icons sequentially blink, and the transceiver receives the signal in the FM mode.

When an FM signal is received while in the DV mode

DV Auto Detect function: OFF

The “DV” and “FM” icons alternately blink, but the audio cannot be heard.

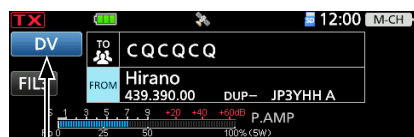

The icons alternately blink.

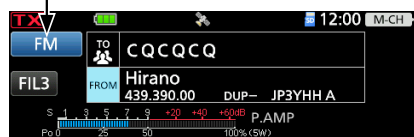

You cannot hear the audio.

DV Auto Detect function: ON

The “DV” and “FM” icons alternately blink, and the audio can be heard.



The icons alternately blink.



Thanks for the nice QSO!

You can hear the audio!

14. D-STAR OPERATION (ADVANCED)

Automatic Reply function

When a call addressed to your own call sign is received, the Automatic Reply function sounds beeps and automatically replies with your call sign. (Default: OFF)

Depending on the setting, a recorded message may be transmitted with the call sign.

1. Open the “Auto Reply” screen.

MENU » **SET > DV SET > Auto Reply**

2. Touch an option.

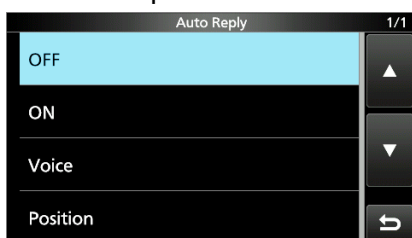

- ON: Automatically replies with your own call sign. (No audio reply is sent)
- Voice: Automatically replies with your call sign and an Auto Reply message recorded on the microSD card (up to 10 seconds).
 - ① If no card is inserted, or no message is recorded, replies with only your own call sign (No audio reply is sent).
- Position: Automatically replies with your own call sign and your position data using the internal GPS receiver.
 - ① When “GPS Select” is set to “OFF” or “Manual,” the internal GPS receiver is temporarily turned ON.

MENU » **GPS > GPS Set > GPS Select**

3. To close the “Auto Reply” screen, push **EXIT** several times.



- Returns to the standby screen, and displays the Auto Reply icon.
- ① When “ON” or “Voice” is selected, the Automatic Reply function is automatically turned OFF, when you push [PTT].
When “Position” is selected, the Automatic Reply function remains ON, when you push [PTT].

Example: After receiving a call from “JM1ZLK,” beeps sound and the transceiver automatically sends a reply call.



The “TO” setting does not change, but “UR: JM1ZLK (Caller’s call sign)” is displayed.

NOTE: The Automatic Reply function temporarily sets the received call sign to “TO” (destination).

TIP: To record the Auto Reply message

You can record the Auto Reply message. See page 14-18 for details.

MENU » **DV A-RPLY**

14. D-STAR OPERATION (ADVANCED)

Automatic Reply function

◇ Recording an Auto Reply message

You can record an Auto Reply message and save it on a microSD card to reply to the call with your voice.



NOTE: Confirm a microSD card is in the card slot.

1. Open the “DV Auto Reply” screen.

MENU » **② > DV A-RPLY**

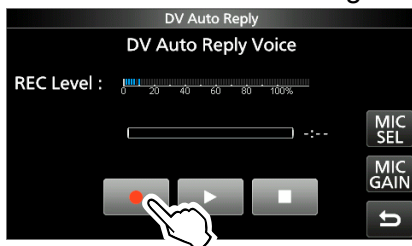
2. Touch  to start recording.



- Touch  to stop recording.
- Touch  to playback the recorded message.

① Information

- The maximum recording time is 10 seconds.
 - Hold the microphone 5 ~ 10 cm (2 ~ 4 inches) from your mouth, then speak at your normal voice level.
 - Touch [MIC GAIN] to open the MIC GAIN adjustment window.
 - Only 1 message can be recorded. The current contents are overwritten if you record again.
3. To close the “DV Auto Reply” screen, push **EXIT**.

The “DV Auto Reply” screen

Adjust the Mic gain so that the “REC Level” meter reads less than 80%.

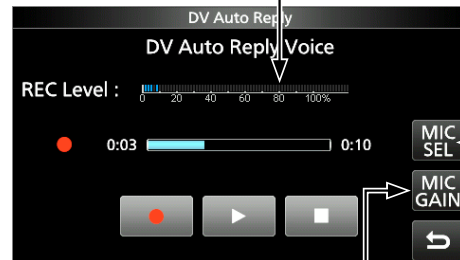

Touch to open the MIC GAIN adjustment window.

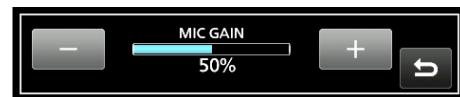

Touch to open the MIC SELECT window.

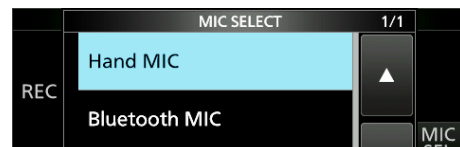

① When you select “Bluetooth MIC” without connecting a Bluetooth headset, “” is displayed.

TIP: How to clear the recorded content

Push **QUICK** on the “DV Auto Reply” screen, and then touch “Clear” in the QUICK MENU screen.

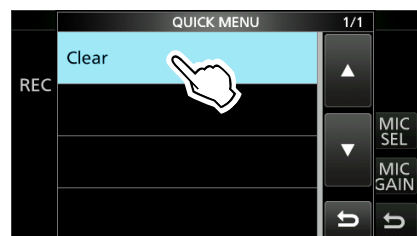

14. D-STAR OPERATION (ADVANCED)

Automatic Reply function

◇ Auto Position Reply function

When you receive a call addressed to your own call sign, but are in a situation that makes it difficult to operate the transceiver, this function sounds beeps and automatically replies with your own call sign and transmits your position data.

After receiving the Auto Position Reply call, the caller's position data is displayed in a window.

① Icom transceivers* displays the position after receiving a call.

① You can turn OFF the caller's position display.

MENU » **SET > Display > Reply Position Display**

* Except for the ID-31A/E, IC-9100, ID-880H/E880, IC-80AD/E80D, IC-92AD/E92D, IC-2820H/E2820, ID-800H, IC-91AD/E91, IC-V82, IC-U82

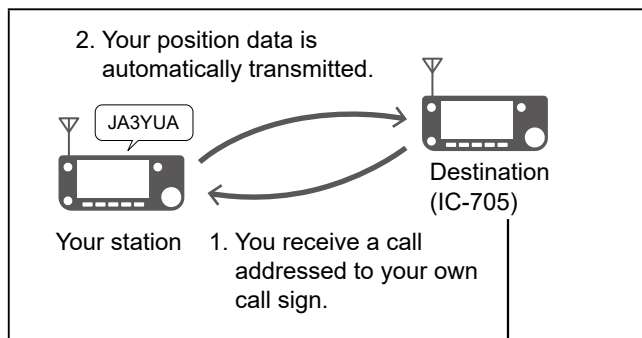

3. After receiving, position data is displayed on the destination's transceiver.



When no valid position data is received

After receiving a call addressed to your own call sign, the internal GPS receiver is temporarily turned ON for approximately 5 minutes to receive your position data, even if "GPS Select" is set to "OFF" or "Manual."

MENU » **GPS > GPS Set > GPS Select**

① When the internal GPS receiver is temporarily ON, and valid position data is received, the transceiver transmits your position data if a call addressed to your own call sign is received again.

TIP:

- The position data is transmitted according to the "GPS TX Mode."
- When the "GPS TX Mode" settings are incorrect for the Automatic Reply function, the transceiver automatically corrects them to reply to a call.
- When "GPS TX Mode" is set to "OFF," "D-PRS" is automatically selected.

Data communication

In addition to digital voice communication, you can send and receive data. Also, you can use the DV Fast Data function for data communication. To send and receive data, a USB cable (user supplied), and a data communication software (user supplied) are required.

NOTE: “DV Data TX” is set to “Auto” as the default setting. When you enter text data into your communication software, the transceiver may automatically transmit it, depending on the software and the software settings.

◇ Connection

Connect the transceiver to your PC using a USB cable, as shown below.

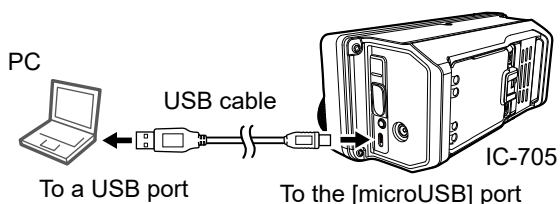

NOTE: Before you start sending data, BE SURE to set the following items on the USB (B) FUNCTION screen.

MENU » **SET > Connectors > USB (B) Function**

- Set “USB (B) Function” to “DV Data.”
- Set “GPS Out” to “OFF.”

◇ Data communication application setting

Set the communication software, as shown below.

- Port: The COM port number that is used by the IC-705.*
- Baud rate: Your desired speed
- Data: 8 bit
- Parity: none
- Stop: 1 bit
- Flow control: Xon/Xoff

* Depending on the PC environment, the COM port number used by the IC-705 may be higher than 5. In that case, use an application that can set it to higher than 5.

◇ Sending data

1. Set your own call sign, the destination call sign, and the repeater call sign.
2. Follow the instructions of your data communication application software.
3. When you enter text data into your communication software, the transceiver may automatically transmit it, depending on the software and its settings.

① When “DV Data TX” is set to “PTT,” pushing [PTT] transmits the text data and a voice signal.

MENU » **SET > DV SET > DV Data TX**

① Before transmitting the data, the transceiver sends a carrier sense signal approximately 500 milliseconds.

NOTE:

- Only ASCII code can be used for data communication.
- The transceiver also has a Message Transmission function that transmits up to 20 characters. (p. 14-11)
- Depending on the combination of your PC and your communication software, some data may be lost.
- While receiving voice or data through the Internet, some packets may be lost due to network error (poor data throughput performance). In such a case, an “L” is displayed on the screen to indicate that packet loss has occurred.

14. D-STAR OPERATION (ADVANCED)

Data communication

◇ DV Fast Data function

To send data using the DV Fast Data function, follow the instructions below.

① DV Fast Data communication can be made by only the following Icom transceivers:

(As of July 2020)

- IC-705
- IC-9700
- ID-31A/E PLUS
- ID-4100A/E
- ID-5100A/E*
- ID-51A/E (PLUS, PLUS2, 50th Anniversary model)

* Usable only when firmware versions CPU M 1.10, S 1.00, C 1.10, and DSP 1.10 or later are installed.

1. Open the DV FAST DATA screen.

MENU » **SET > DV SET > DV Fast Data**

2. Touch "Fast Data."

3. Touch "ON."

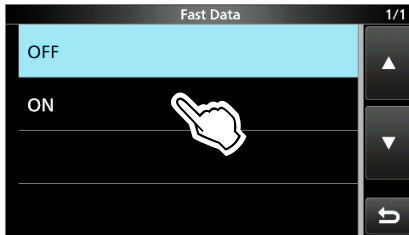

4. To close the DV FAST DATA screen, push **EXIT** several times.

Digital squelch functions

The digital squelch opens only when you receive a signal addressed to your own call sign, or a signal that includes a matching digital code. You can silently wait for calls from others. You can independently set the Digital squelch function in the VFO mode, Memory mode, Call channel mode, or DR function.

◇ The Digital Call Sign squelch setting

1. Push **[FUNCTION]**.
 - Opens the FUNCTION screen.
2. Touch **[D.SQL]** several times to select “DSQL.”



① Touching **[D.SQL]** selects “DSQL,” “CSQL,” or “OFF.”

3. Push **[EXIT]** to close the FUNCTION screen.

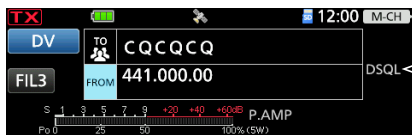

- When the received signal includes a matching call sign, the squelch opens and you can hear the audio.
- ① When the received signal does not include a matching call sign, the digital call sign squelch does not open. However, the S/RF meter displays the received signal level.

NOTE:

- **DO NOT** use the Digital Call Sign Squelch function when communicating with 2 or more stations, because the function opens only when receiving a signal addressed to your own call sign. Therefore the function can be used when communicating with only 1 station.
- Even if the squelch is closed by the Digital Call Sign Squelch function, you can receive data in the DV mode.

◇ The Digital Code Squelch setting

1. Push **[FUNCTION]**.
 - Opens the FUNCTION screen.
2. Touch **[D.SQL]** several times to select “CSQL.”



① Touching **[D.SQL]** selects “DSQL,” “CSQL,” or “OFF.”

3. Touch **[D.SQL]** for 1 second.
4. Rotate **(MAIN DIAL)** to select a digital code.

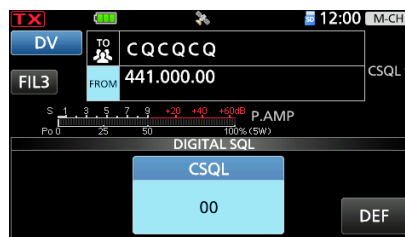

- Range: 00 ~ 99
- ① Touch **[DEF]** for 1 second to return the value to the default.

NOTE: Even if the squelch is closed by the Digital Code Squelch function, you can receive data in the DV mode.

14. D-STAR OPERATION (ADVANCED)

Repeater list

You can save repeater information for quick and simple communication in up to 2500 repeaters (repeater list) in up to 50 Groups. Data must be in the repeater list to use the DR function. You can add and edit repeater content and groups in the repeater list.

You can enter 4 types of frequencies into the repeater list, as shown below:

- DV Repeater
- DV Simplex
- FM Repeater
- FM Simplex

◇ Repeater list contents

The following contents are included in the repeater list:

See page 14-24 for details.

- TYPE: Communication type
- NAME: Repeater name
- SUB NAME: Repeater sub name
- CALL SIGN: Repeater call sign and port letter
- GW CALL SIGN: Gateway repeater's call sign and port "G"
- GROUP: Repeater group
- USE(FROM): Access repeater use
- FREQUENCY: Access repeater's frequency
- DUP: Duplex direction
- OFFSET FREQ: Frequency offset
- TONE: Tone setting
- REPEATER TONE: Repeater tone
- POSITION: Position data accuracy level
- LATITUDE: Latitude of the repeater
- LONGITUDE: Longitude of the repeater
- UTC OFFSET: UTC Offset

TIP:

- For easy operation, the repeater list is preloaded into your transceiver. However, if you do an All Reset, the CPU deletes all setting data, the Memory channels, and the repeater list. We recommend that you back up the memory data to a microSD card or save it to a PC using the CS-705 PROGRAMMING SOFTWARE.
- The repeater list can be downloaded from the Icom website.

<https://www.icomjapan.com/support/>

Example: "Hirano" repeater information

The image displays four sequential screenshots of the 'REPEATER LIST (DV Repeater)' menu, showing the configuration for a repeater named 'Hirano'. Each screen has a page indicator in the top right corner (1/4, 2/4, 3/4, 4/4).

- Screen 1 (1/4):** TYPE: DV Repeater; NAME: Hirano; SUB NAME: Osaka; CALL SIGN: JP3YHH A.
- Screen 2 (2/4):** GW CALL SIGN: JP3YHH G; GROUP: 12: Japan; USE (FROM): YES; FREQUENCY: 439.390.000.
- Screen 3 (3/4):** DUP: DUP-; OFFSET FREQ: 5.000.0; POSITION: Approximate; LATITUDE: 34' 37.55'N.
- Screen 4 (4/4):** LONGITUDE: 135' 34.09'E; UTC OFFSET: + 9:00.

14. D-STAR OPERATION (ADVANCED)

Entering new information into the repeater list

This section describes how to manually enter new repeater information into the repeater list. The required setting items differ, depending on your communication usage. Confirm the required items, as shown below.



NOTE: To enter repeater information into the repeater list, the repeater's call sign must be entered first.

◇ Required items for the communication cases

Repeater list contents	Used as an access repeater	Used as a destination repeater	Used as an FM repeater	Simplex (FROM)	
TYPE	DV Repeater	DV Repeater	FM Repeater	DV Simplex	FM Simplex
NAME	○	○	○	○	○
SUB NAME	○	○	○	○	○
CALL SIGN	●	●	○	N/A	N/A
GW CALL SIGN	● (For a Gateway call)	●	N/A	N/A	N/A
GROUP	○	○	○	○	○
USE(FROM)	●	○	●	●	●
FREQUENCY	●	○	●	●	●
DUP	●	○	●	N/A	N/A
OFFSET FREQ	●	○	●	N/A	N/A
TONE	N/A	N/A	○	N/A	○
REPEATER TONE	N/A	N/A	○	N/A	○
POSITION	○	○	○	○	○
LATITUDE	○	○	○	○	○
LONGITUDE	○	○	○	○	○
UTC OFFSET	○	○	○	○	○

●: Must be entered
 ○: Possible to enter
 N/A: Not Applicable

14. D-STAR OPERATION (ADVANCED)

Entering new information into the repeater list

◇ Entering new information into the repeater list

Step 1. Selecting the repeater group

1. Open the DV MEMORY screen.

MENU » ② > **DV MEMORY**



2. Touch "Repeater List."

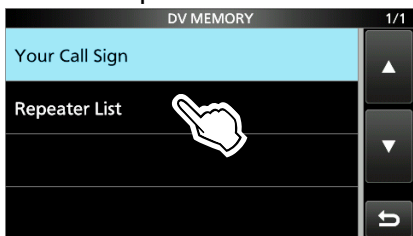

3. Touch a repeater group to add a repeater to.
(Example: 12: Japan)



- Displays the repeater list of the selected repeater group.

4. Push **QUICK**.
5. Touch "Add."

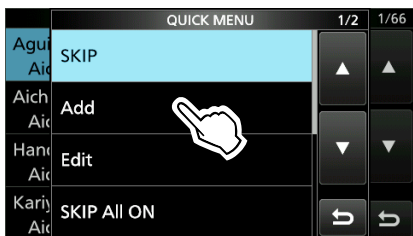

- The REPEATER LIST EDIT screen is displayed.

Step 2. Selecting the communication type

1. Touch "TYPE."
2. Touch the communication type.
 - DV Repeater: Repeater operation in the DV mode.
 - DV Simplex: Simplex operation in the DV mode.
 - FM Repeater: Repeater operation in the FM mode.
 - FM Simplex: Simplex operation in the FM mode.

Step 3. Entering the repeater name

1. Touch "NAME."
2. Enter a name of up to 16 characters.
3. After entering, touch [ENT].

Step 4. Entering the repeater sub name

1. Touch "SUB NAME."
2. Enter a sub name of up to 8 characters.
3. After entering, touch [ENT].

Step 5. Entering the repeater call sign

- ① When **Step 2. Selecting the communication type** is set to "DV Simplex" or "FM Simplex," go to **Step 7. Changing the repeater group.**

1. Touch "SUB NAME."
2. Enter a sub name of up to 8 characters.
3. After entering, touch [ENT].

14. D-STAR OPERATION (ADVANCED)

Entering new information into the repeater list

◇ Entering new information into the repeater list

Step 6. Entering the gateway repeater call sign

- ① This item is displayed when **Step 2. Selecting the communication type** is set to “DV Repeater.”
- ① The 8th digit in the call sign, entered in **Step 5. Entering the repeater call sign** is automatically set to “G” as the gateway port, so you can skip this setting and go to the next item.

1. Touch “GW CALL SIGN.”
2. Enter a gateway repeater call sign of up to 8 characters, including spaces.
 - ① Only a space or “G” can be entered in the 8th digit.
3. After entering, touch [ENT].

Step 7. Changing the repeater group

- ① The repeater group that is selected in **Step 1. Selecting the repeater group** is displayed. You can skip this setting and go to the next item. To change the group, follow the steps, described below.

1. Touch “GROUP.”
2. Touch the repeater group. (01 ~ 50)

Step 8. Setting “USE(FROM)” to be used as an Access repeater

- ① You can use the entered repeaters as an access repeater when using the DR function. When not using as an access repeater, select “NO,” and go to **Step 14. Selecting the position data accuracy level**. In that case, the entered repeater is not displayed in “FROM” on the DR screen.

1. Touch “USE(FROM).”
2. Touch “YES” to use the repeater as an access repeater.

Step 9. Entering the access repeater frequency

1. Touch “FREQUENCY.”
2. Enter the repeater frequency.
3. After entering, touch [ENT].

Step 10. Selecting the Duplex direction

- ① When **Step 2. Selecting the communication type** is set to “DV Simplex” or “FM Simplex,” this item is not displayed.
- ① “DUP-” is automatically set when the access repeater frequency is entered in **Step 9. Entering the access repeater frequency**. If necessary, you can change the Duplex direction.

1. Touch “DUP.”
2. Touch a Duplex direction.
 - OFF: Turn the duplex function OFF.
 - DUP-: The transmit frequency shifts down from the receive frequency by the offset amount.
 - DUP+: The transmit frequency shifts up from the receive frequency by the offset amount.

Step 11. Entering the frequency offset

- ① When **Step 2. Selecting the communication type** is set to “DV Simplex” or “FM Simplex,” this item is not displayed.
- ① The offset value* is automatically set when the access repeater frequency is entered in **Step 9. Entering the access repeater frequency**. If necessary, you can change the frequency offset.
 - * The default value differs, depending on the transceiver version.

1. Touch “OFFSET FREQ.”
2. Enter the frequency offset.
 - Range: 0.000.00 ~ 99.999.9 MHz
3. After entering, touch [ENT].

Step 12. Setting the tone

- ① When **Step 2. Selecting the communication type** is set to “DV Repeater” or “DV Simplex,” this item is not displayed.

1. Touch “TONE.”
2. Touch an option.
 - OFF: Turn OFF the Tone function.
 - TONE: Select when the repeater requires an access tone.
 - TSQL: Select when you want to use the tone squelch in simplex operation.

14. D-STAR OPERATION (ADVANCED)

Entering new information into the repeater list

◇ Entering new information into the repeater list

Step 13. Selecting the repeater tone frequency

① When **Step 2. Selecting the communication type** is set to “DV Repeater” or “DV Simplex,” this item is not displayed.

① This setting is required when **Step 12. Setting the tone** is set to “TONE” or “TSQL.”

1. Touch “REPEATER TONE.”
2. Set the repeater tone frequency.
3. Push **[EXIT]**.

Step 14. Selecting the position data accuracy level

① When the Near Repeater Search function is not used, or the distance between your position and a repeater is not needed, select “None,” and go to **Step 17. Setting the UTC offset**.

1. Touch “POSITION.”
2. Touch the position data accuracy level.
 - None: Select when the repeater has no position data.
 - Approximate: Select when the entered position data is approximately correct.
 - Exact: Select when the entered position data is exactly correct.

Step 15. Entering the latitude

① This item is displayed only when **Step 14. Selecting the position data accuracy level** is set to “Approximate” or “Exact.”

1. Touch “LATITUDE.”
2. Enter the latitude.
 - ① Touching [N/S] selects a north latitude (N) or a south latitude (S).
3. After entering, touch **[ENT]**.

Step 16. Entering the longitude

① This item is displayed only when **Step 14. Selecting the position data accuracy level** is set to “Approximate” or “Exact.”

1. Touch “LONGITUDE.”
2. Enter the longitude.
 - ① Touching [E/W] selects an east longitude (E) or a west longitude (W).
3. After entering, touch **[ENT]**.

Step 17. Setting the UTC offset

① Universal Time Coordinated (UTC) offset is the time difference between UTC and repeater local time. This is a useful function to know the local time of the destination repeater before you make a call.

1. Touch “UTC OFFSET.”
2. Set the time difference between UTC and the local time.
3. Push **[EXIT]**.

Step 18. Saving the repeater list

1. Touch “<<Add Write>>.”
 - The confirmation dialog is displayed.
2. Touch **[YES]**.
 - The entered contents are saved in the repeater list, and the display returns to the selected repeater group screen.

TIP: How to cancel the entered data

1. Push **[EXIT]**.
 - The confirmation dialog is displayed.
2. Touch **[YES]**.

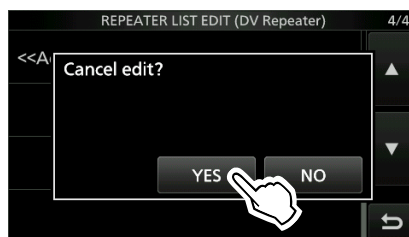

- Cancels the entry and returns to the selected repeater group screen.

14. D-STAR OPERATION (ADVANCED)

Entering new information into the repeater list

◇ Editing repeater data

You can edit repeater data. This is useful when already-entered data is incorrect, has changed, or some data needs to be added to the list.

1. Open the REPEATER GROUP screen.
MENU » **②** > DV MEMORY > **Repeater List**
2. Touch a repeater group where the repeater you want to edit is listed. (Example: 12: Japan)



3. Touch a repeater that you want to edit for 1 second. (Example: Hirano)



4. Touch "Edit."

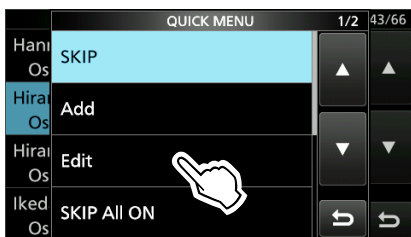

- The REPEATER LIST EDIT screen is displayed.
5. Touch an item, then edit it.
 ① See pages 14-25 ~ 14-27 for details.
 6. After editing, touch "<<Overwrite>>."



- The confirmation dialog is displayed.

7. Touch [YES].

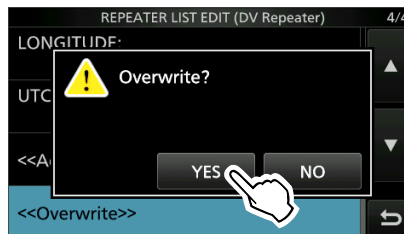

- The edited contents are saved into the repeater list, and returns to the selected repeater group screen.
8. To close the Repeater List screen, push **EXIT** several times.

NOTE: The currently selected repeater on the DR screen cannot be edited. To edit the repeater, select another repeater on the DR screen.

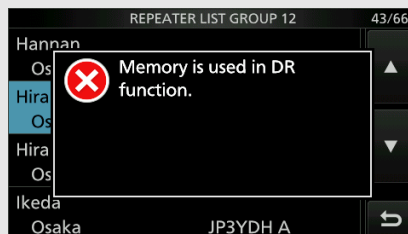

14. D-STAR OPERATION (ADVANCED)

Entering new information into the repeater list

◇ Deleting repeater data

1. Open the REPEATER GROUP screen.
MENU » ② > DV MEMORY > **Repeater List**
2. Touch a repeater group where the repeater you want to delete is listed. (Example: 12: Japan)



NOTE: The currently selected repeater on the DR screen cannot be deleted. To delete the repeater, select another repeater on the DR screen.

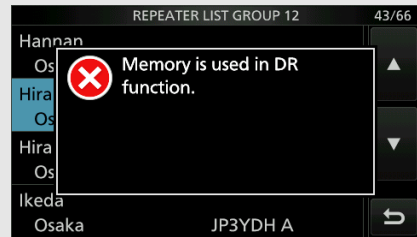

3. Touch a repeater that you want to delete for 1 second. (Example: Hirano)



4. Touch "Delete."

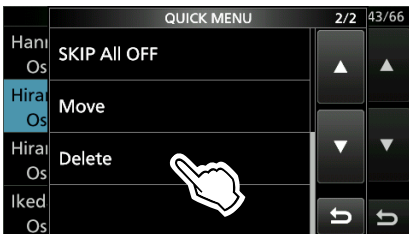

- The confirmation dialog is displayed.

5. Touch [YES].

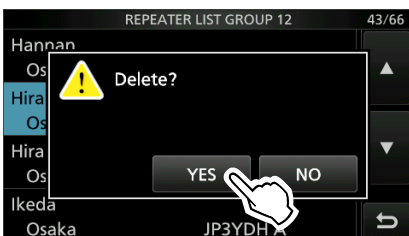

- The selected repeater contents are deleted from the repeater list, and returns to the selected repeater group screen.

6. To close the Repeater List screen, push **EXIT** several times.

14. D-STAR OPERATION (ADVANCED)

Entering new information into the repeater list

◇Rearranging the display order of the repeaters

You can move the entered repeaters to rearrange their display order in the selected repeater group.

Example: Moving “Hirano/Icom” above “Nakano.”

1. Open the REPEATER GROUP screen.
MENU » **② > DV MEMORY > Repeater List**
2. Touch a repeater group where the repeater you want to move is listed. (Example: 12: Japan)

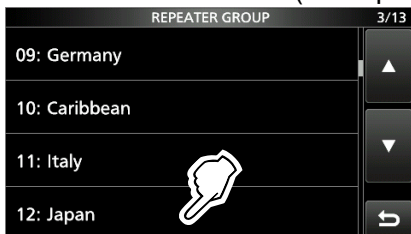

3. Touch a repeater that you want to move for 1 second. (Example: Hirano)



4. Touch “Move.”

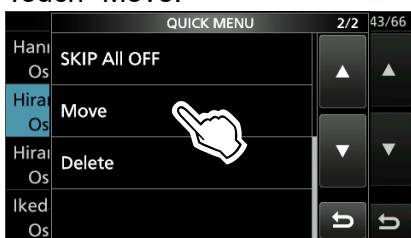

5. Touch a repeater to insert the repeater you want to move above it.



- The selected repeater is inserted above the destination repeater name.
- ① If you touch “<<Move End>>,” the repeater is moved to the bottom of the group.

6. To close the Repeater List screen, push **EXIT** several times.

◇Adding new repeater information from RX History

1. Open the RX HISTORY screen.
MENU » **② > CD**
2. Rotate **MAIN DIAL** to display the repeater you want to add to the repeater list.



3. Touch [DETAIL].
4. Rotate **MAIN DIAL** to display “RXRPT1” and “RXRPT2.”



5. Push **QUICK**.
6. Touch “Add To Repeater List.”



7. Touch the repeater call sign that you want to add to the repeater list.

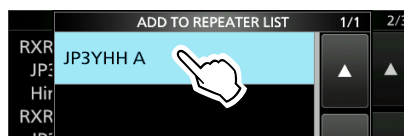

- Displays the REPEATER LIST EDIT screen. The selected repeater call sign is automatically entered.

① See pages 14-25 ~ 14-27 to edit the contents.

8. Touch “<<Add Write>>.”
 - The confirmation dialog is displayed.
9. Touch [YES].
 - The repeater contents are added to the repeater list, and the display returns to the RX HISTORY screen.

14. D-STAR OPERATION (ADVANCED)

Entering new information into the repeater list

◇ Skip setting for the DR scan

You can set repeaters as scan skip repeaters. The selected repeaters are skipped for faster scanning. You can set the skip setting to all repeaters in the selected repeater group, or to individual repeaters.

① When a repeater is set as a skip repeater, its “USE (FROM)” setting is automatically set to “NO.” In that case, the repeater cannot be selected in “FROM” (Access repeater) on the DR screen.

Individual skip setting

- Open the REPEATER GROUP screen.
[MENU] » **② > DV MEMORY > Repeater List**
- Touch a repeater group where the repeater you set the skip setting is listed.
 (Example: 12: Japan)
- Touch a repeater that you want to skip for 1 second. (Example: Hirano)

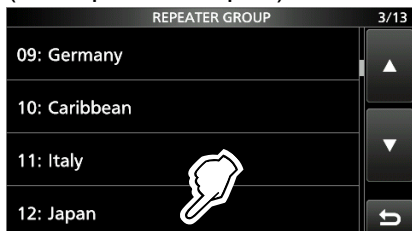

- Touch “SKIP.”

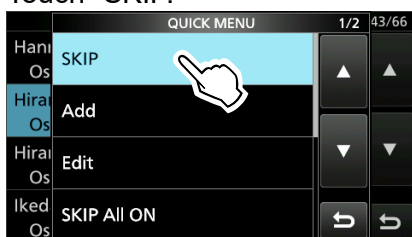

- Displays “SKIP” in the upper right corner.
- ① To cancel the skip setting, touch “SKIP” again.
- ① To set the skip setting to all repeaters in the group, touch “SKIP All ON.”

- To close the Repeater List screen, push **[EXIT]** several times.

Group skip setting

On the REPEATER GROUP screen, push **[QUICK]**, then touch “SKIP All ON” to skip the repeaters in the group during the DR scan.

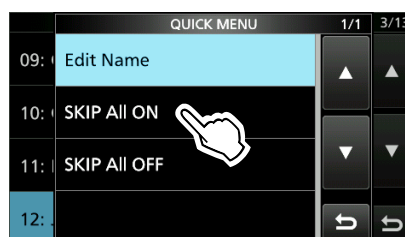

- ① To cancel the skip settings in the group, touch “SKIP All OFF.”

TIP:

- When you select “Repeater List” on the FROM SELECT screen, you can set the skip setting as described to the left.

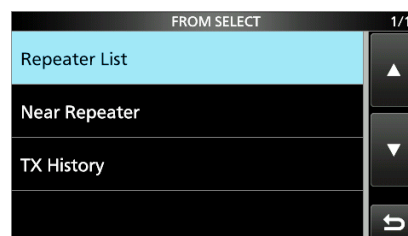

- When “FROM” is selected on the DR screen, push **[QUICK]**, then touch “SKIP” to set the skip setting, as shown below.

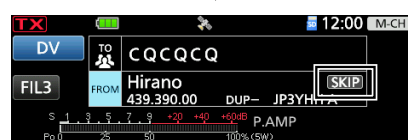
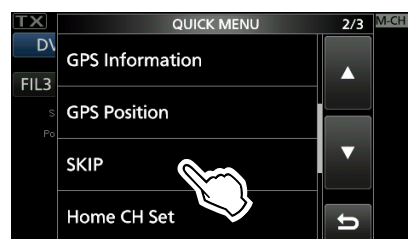

14. D-STAR OPERATION (ADVANCED)

Entering new information into the repeater list

◇ Entering or editing a repeater group name

1. Open the REPEATER GROUP screen.
MENU » **②** > DV MEMORY > **Repeater List**

2. Touch a repeater group that you edit the name for 1 second.

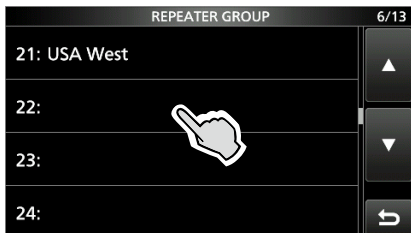

3. Touch "Edit Name."



4. Enter a group name of up to 16 characters, and then touch [ENT].

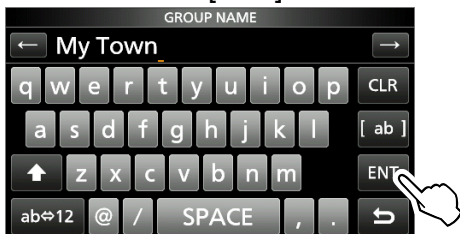

5. To close the REPEATER GROUP screen, push **EXIT** several times.

Your Call Sign

◇ Entering Your Call Sign

You can manually enter a Your (destination) Call Sign. When a Your Call Sign is set to “TO,” you can make a call to the station, even if you do not know where the station is currently located. Up to 300 “Your Call Signs” can be entered.

Example: Entering “Rick/JM1ZLK” to the Your Call Sign memory.

1. Open the YOUR CALL SIGN screen.

MENU » ② > DV MEMORY > **Your Call Sign**

2. Push **QUICK**.
3. Touch “Add.”



4. Touch “NAME.”



5. Enter a station name of up to 16 characters, and then touch **[ENT]**.

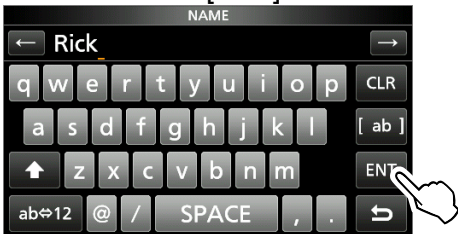

6. Touch “CALL SIGN.”

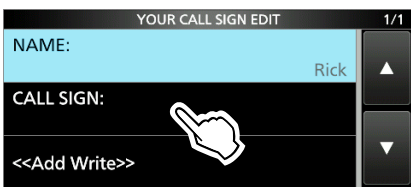

7. Enter a call sign of up to 8 characters, including spaces, and then touch **[ENT]**.

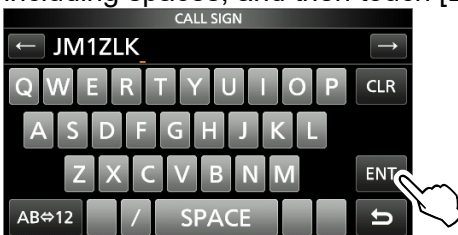

8. Touch “<<Add Write>>.”



- The confirmation dialog is displayed.

9. Touch **[YES]**.



10. To close the YOUR CALL SIGN screen, push **EXIT** several times.

TIP:

To cancel the entered call sign

Push **EXIT**, then the “Cancel edit?” window is displayed. Touch **[YES]** to cancel the entry and return to the YOUR CALL SIGN screen.

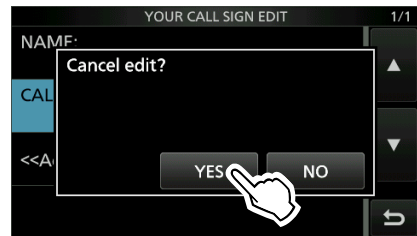

To edit the entered call sign

Touch “Edit” in step 3.

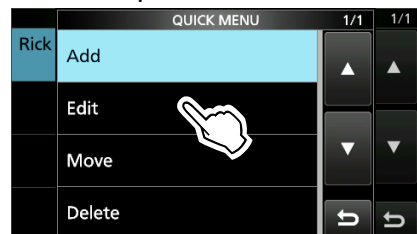

14. D-STAR OPERATION (ADVANCED)

Your Call Sign

◇ Deleting Your Call Sign

1. Open the YOUR CALL SIGN screen.
MENU » ② > DV MEMORY > **Your Call Sign**
2. Touch a call sign that you want to delete for 1 second.

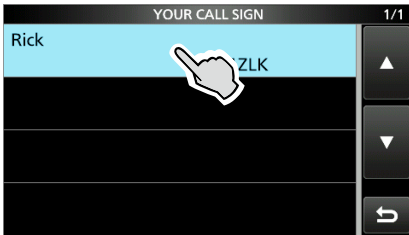

3. Touch "Delete."

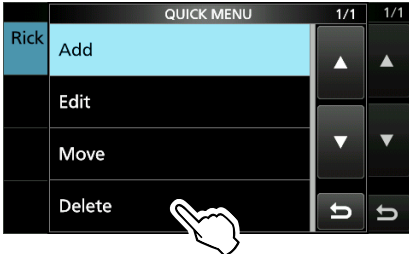

- The confirmation dialog is displayed.

4. Touch [YES].

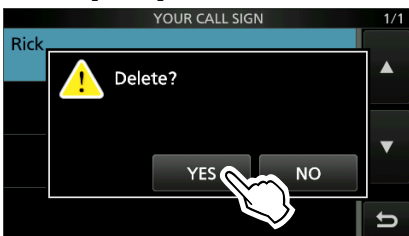

- The selected call sign is deleted from the Your Call Sign list, and the returns to the YOUR CALL SIGN screen.

5. To close the YOUR CALL SIGN screen, push **EXIT** several times.

NOTE: The currently selected Your Call Sign on the DR screen cannot be edited or deleted. To edit or delete the Your Call Sign, select another Your Call Sign on the DR screen.

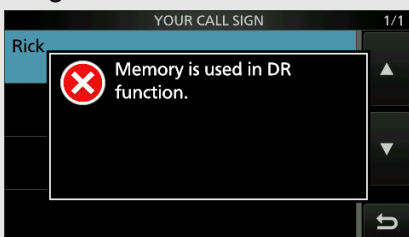

◇ Rearranging the display order of Your Call Signs

You can move Your Call Signs to rearrange their display order. If the stations you often communicate with are moved to the top of the list, it is easy to find them.

Example: Moving "Rick" above "Eddy."

1. Open the YOUR CALL SIGN screen.
MENU » ② > DV MEMORY > **Your Call Sign**
2. Touch a call sign that you want to move for 1 second.

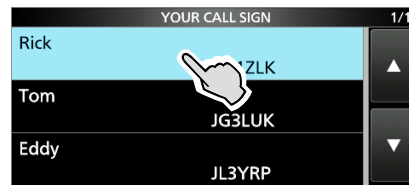

3. Touch "Move."

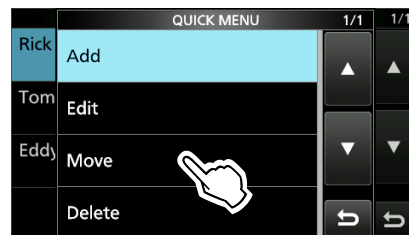

4. Touch the position to insert the Your Call Sign you want to move the call sign above.



- While moving, "DESTINATION" blinks.
- The selected call sign is inserted above the destination call sign.

- ① If you touch "<<Move End>>," the Your Call Sign is moved to the bottom of the group.
5. To close the YOUR CALL SIGN screen, push **EXIT** several times.

Manually setting Call Signs

Set or view the “UR,” “R1,” “R2,” and “MY” call signs to use in the DV mode.

MENU » **② > CS**

When not using the DR function, sets the call signs on this screen.

For Simplex operation (DV mode)

You can set the “UR” and “MY” call signs.

For Duplex (repeater) operation (DV mode/DR function)

You can set only the “MY” call sign when the DR function is ON.

<To manually set the Duplex (repeater) operation>

Example: Making a gateway CQ call to Kirkland repeater (N71H B) from the Hirano repeater (JP3YHH A), in the DV mode.

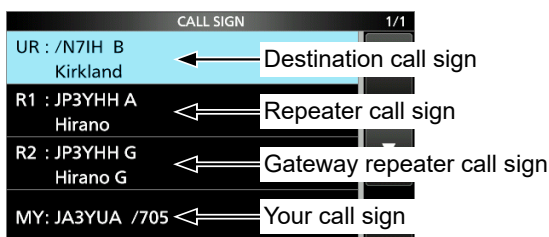

① Before starting to set the call sign, set the frequency of your Access repeater and duplex direction on the standby screen.

TIP: When the Digital Repeater Set function is ON, the repeater call sign is automatically set.

MENU » **SET > DV Set > Digital Repeater Set**

Step 1. Setting the call sign “R1”

1. Touch “R1” for 1 second.
2. Touch “Edit.”
3. Enter the repeater call sign of up to 8 characters, including spaces.
(Example: JP3YHH A)
4. Touch [ENT].
 - Sets the entered repeater call sign.

Step 2. Gateway “R2” setting

1. Touch “R2.”
 - ① To manually enter a call sign, touch “R2” for 1 second, then touch “Edit.”
2. Touch “GW.”

About the RPT2 SELECT screen

NOT USED*	For local area calls
GW	To select the gateway call sign from the repeater list.
Repeater name	To select the repeater that has the same gateway as the “R1” repeater.

Step 3. Destination “UR” setting

1. Touch “UR.”
 - ① To manually enter a call sign, touch “UR” for 1 second, then touch “Edit.”
2. Touch “Gateway CQ.”
3. Touch repeater group where your destination repeater is listed.
4. Touch a destination repeater.

About the YOUR SELECT screen

CQCQCQ	To select “CQCQCQ” to make a non-call sign specific call.
Gateway CQ*	To select “Gateway CQ” to make a call using the repeater list.
Your Call Sign	To select the destination “UR” call sign using the Your Call Sign memory.
RX History	To select the destination “UR” call sign using RX History.
TX History	To select the destination “UR” call sign using TX History.

* Not displayed in the Simplex mode.

14. D-STAR OPERATION (ADVANCED)

Are your settings correct?

If you make a Local Area call with a gateway repeater still selected in “TO,” the destination repeater will be busy while you transmit. The stations that want to use the repeater as their Access repeater cannot access it, as shown below.

BE SURE to set CQCQCQ in “TO” on the DR screen when you intend to make a Local Area call, or after you finish a Gateway call.

Example: JA3YUA wants to make a Local Area call.

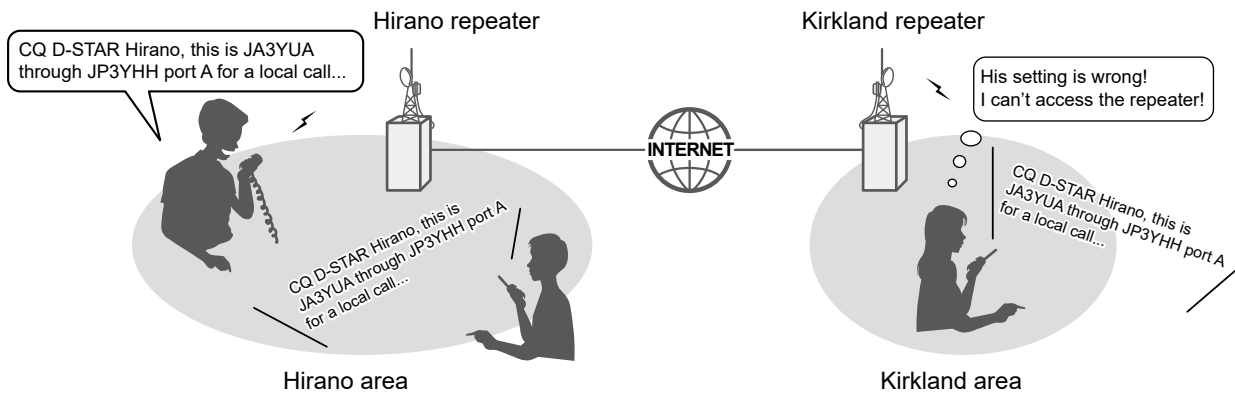

JA3YUA's setting

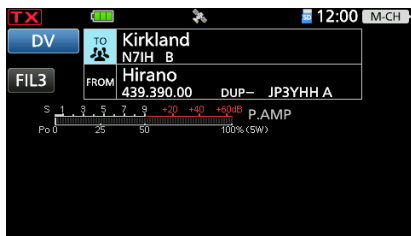

The destination (“TO”) setting is incorrect.

Correct setting

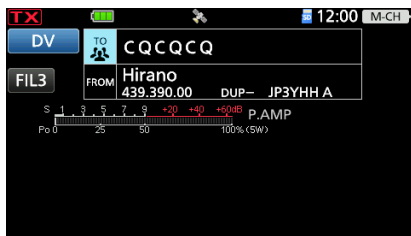

To make a Local Area call, set the destination (“TO”) to “CQCQCQ.” See page 14-7 for details.

NOTE: With this setting, you can make a Local Area call, but the destination Repeater, selected in “TO,” is also busy while you transmit. The stations that want to use the repeater as their Access Repeater cannot access it.

Using the RS-MS1A

The RS-MS1A is a freeware application for Android devices.

With the RS-MS1A, you can use the extended D-STAR functions to exchange image files or text messages, or display the received D-PRS station data on a map program.

To use the RS-MS1A, download it from the Google Play store of your Android device.

◇ Required items

The following system is required to use the RS-MS1A. Required items differ, depending on the connecting method.

(As of July 2020)

When using a USB cable

- **Android device**
Android 5.0 or later with the USB host function.
- **Cable** (purchase separately)
OPC-2417 DATA CABLE (USB micro-B/USB micro-B)
or
OPC-2418 DATA CABLE (USB micro-B/USB Type-C)

When using the Bluetooth function

- **Android device**
Android 5.0 or later with the Bluetooth function.

NOTE: Some functions may not work correctly,
 • depending on other applications installed in the Android device.
 • depending on the memory capacity.

TIP: The USB host function is needed to use a USB device with an Android device. To check whether or not your Android device has the USB host system, ask the Android device's manufacturer.

- ① The RS-MS1A has been tested with the Android 5.x.x, 6.x.x, 7.0, 8.0, 9.0, and 10.0.
- ① For operations or settings of the Android device, read the Android device's instruction manual.
- ① Display indications may differ depending on the OS version or settings.

◇ Installing the application

1. Start the Android device.
2. Touch "Play store."
3. Enter "RS-MS1A."
① Do not abbreviate the application name to be sure to find it.
4. Touch "🔍 (search)."
• The RS-MS1A application information is displayed.
① If your Android device is not compatible with the RS-MS1A, the application is not displayed.
5. Touch "RS-MS1A."
6. Touch "Install."
7. Touch "Agree to download."
• Starts installing the application.
• After the installation is completed, the icon is displayed on your home screen.

◇ When using a USB cable

Android device with the USB host function

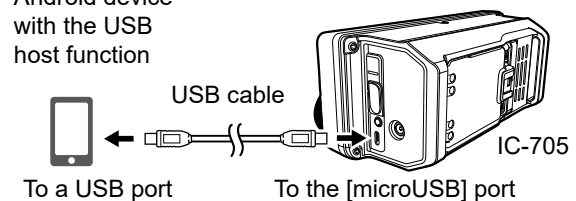

- ① Connect the USB micro-B connector (for the OPC-2417: with the white tube) to the transceiver and the other connector to an Android device.

NOTE:

- Turn OFF the transceiver before connecting or removing the cable.
- When an Android device is connected, the USB connection indicator (🔌) is displayed on the transceiver. If the indicator is not displayed, enable your Android device to detect the USB device.
- Remove the USB cable when you do not use the cable. Otherwise, the battery will be quickly exhausted.
- If the application selection window is displayed, select "RS-MS1A" to start the application.
- When the Android device does not work properly, try putting the transceiver at a place farther away from the Android device.

14. D-STAR OPERATION (ADVANCED)

Using the RS-MS1A

◇ When using the Bluetooth function

This section describes how to connect to the transceiver from an Android device.
Before connecting, pair the transceiver with an Android device. (p. 10-5)

Step 1. Preparing for the connection (Transceiver)

Set “CI-V Transceive” to ON to control the transceiver and the RS-MS1A with CI-V commands.

MENU » SET > Connectors > CI-V > **CI-V Transceive**

Step 2. Starting the RS-MS1A (Android device)

Touch the RS-MS1A to start.

① See page 14-37 for details on downloading the RS-MS1A.

Step 3. Connecting to the transceiver (Android device)

Touch the transceiver Bluetooth unit’s name displayed on the RS-MS1A.

- Starts to connect.

① When your call sign has not been entered in the transceiver, you should enter in before you connect.

① After the connection has succeeded, the transceiver displays “* * * Connected,” and the Bluetooth icon is displayed.

“* * *” is the Bluetooth name of the Android device.

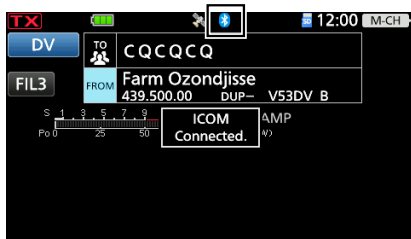

① On the PAIRING/CONNECT screen, “(Connect)” is displayed under the Android device name.

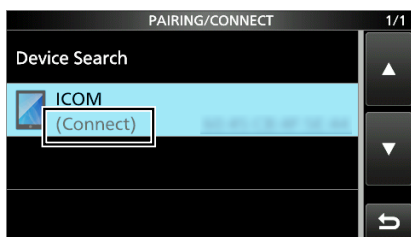

NOTE: If you cannot connect, check that the same CI-V address is set between the transceiver and the RS-MS1A.
You can see the CI-V setting as described below:

Transceiver:

“CI-V Address” in the SET mode. (Default: A4)

MENU » SET > Connectors > CI-V > **CI-V Address**

RS-MS1A:

“Application Setting” → “CI-V setting”
(Default: Transceiver[A4])

TIP: To connect to the Android device from the transceiver:

When the RS-MS1A is started on the Android device, you can connect to the device from the transceiver.

1. Open the BLUETOOTH SET screen.
MENU » SET > **Bluetooth Set**
 2. Touch “Pairing/Connect.”
 3. Touch the Android device name displayed in the pairing list.
 4. Touch [YES].
 - Displays “* * * Connecting...” (“* * *” is the Bluetooth name of the Android device.)
- ① On the PAIRING/CONNECT screen, “(Connect)” is displayed under the Android device name.

15. ABOUT THE DV GATEWAY FUNCTION

About the DV Gateway function

Even if you cannot access a D-STAR repeater, you can make Gateway calls with the DV Gateway function. The function has two modes, the Terminal mode and the Access Point mode.

- ① Other stations can also directly communicate using the DV Gateway function, only if they use call sign routing.
- ① When using the DV Gateway function, you cannot make a direct Local Area call.

IMPORTANT:

- Before operating in the Terminal mode or the Access Point mode, **BE SURE** to check your local regulations or laws.
 - Register your call sign (MY) at a gateway server.*
 - Register the Terminal/AP call sign that is set in the transceiver, RS-MS3A, or RS-MS3W to the RS-RP3C GATEWAY CONTROL SOFTWARE as the access point.*
- * Ask the gateway repeater administrator for details.

Terminal mode

The Terminal mode enables you to make Gateway calls through the Internet. In the Terminal mode, the transceiver does not transmit or receive RF signals through the antenna.

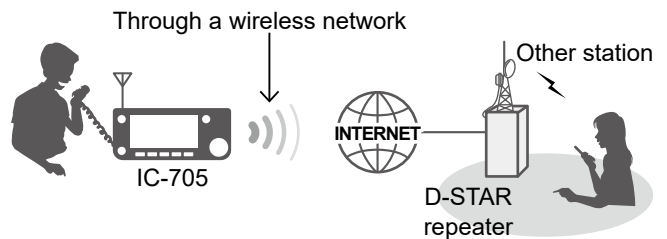

Access Point mode

The Access Point mode enables you to use another D-STAR transceiver and remotely*¹ make Gateway calls through an Access Point transceiver.

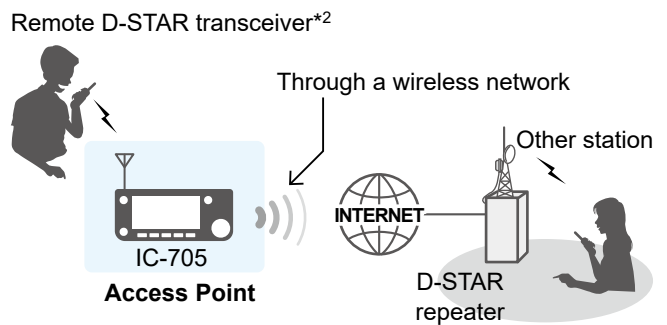

*¹ Within the transmit and receive range of the Access Point transceiver. The range will vary, depending on the operating environment.

*² Any model as long as the transceiver is D-STAR capable. Only one D-STAR transceiver can access the Access Point at the same time.

NOTE: When using the DV Gateway function

- When operating in the Access Point mode, you need two call signs. One for the Access Point transceiver and one for the Remote D-STAR transceiver. (p. 15-3)
- You need an Internet connection with an IPv4 Global IP address. If you use a cellular system, you need an IPv4 Global IP address assigned to your Windows or Android device.
- When you use your Windows or Android device, read the RS-MS3W or RS-MS3A instruction manual in addition to this document. They can be downloaded from the Icom website. (pp. 15-12, 15-13)

When using the External Gateway function

Even if you cannot connect the transceiver to the Internet directly, or you want to use a cellular system, you can use the DV Gateway function by using a Windows or Android device that is running the RS-MS3W or RS-MS3A application software.

- ① To connect the transceiver to your device, you need a USB cable.
- When your device has a microUSB Type-B port, use the OPC-2417 (option).
 - When your device has a USB Type-C port, use the OPC-2418 (option).
 - When your device has a USB Type-A port, use a user supplied cable.

Terminal mode

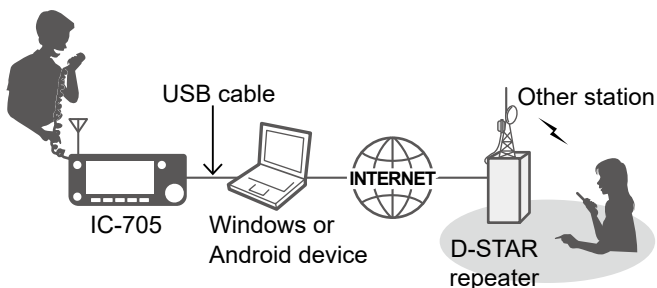

Set “Gateway Select” to “External Gateway”

1. Open the “Gateway Select” screen.
MENU » **②** > DV GW > **Gateway Select**
2. Touch “External Gateway (USB (B)).”

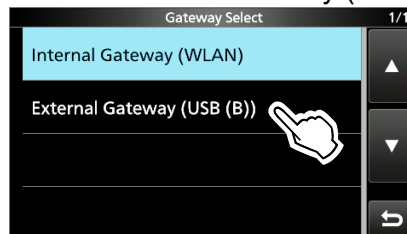

Access Point mode

Remote D-STAR transceiver*

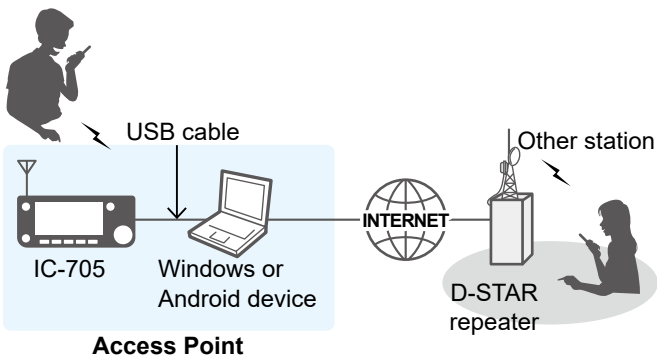

* Any model as long as the transceiver is D-STAR capable.
 Only one D-STAR transceiver can access the Access Point at the same time.

About the Terminal and Access Point (AP) Call sign

◇ When operating in the Terminal mode

IMPORTANT:

- Register your call sign (MY) at a gateway server.*
- Register the Terminal/AP call sign that is set in the transceiver, RS-MS3A, or RS-MS3W application software to the RS-RP3C repeater gateway software as the access point.*

* Ask the gateway repeater administrator for details.

① Information

- The Terminal/AP Call sign should be 8 characters long. Enter spaces between MY call sign and the 8th character.
- Enter a unique ID suffix between A to Z, except for G, I, and S, at the end of MY Call Sign for the 8th character.
- Call signs shown below are just examples.

When using the Internal Gateway function

Enter the Terminal Call sign in “Terminal/AP Call sign” in the transceiver. (p. 15-10)

MENU » ② > DV GW > Internal Gateway Settings > Terminal/AP Call sign

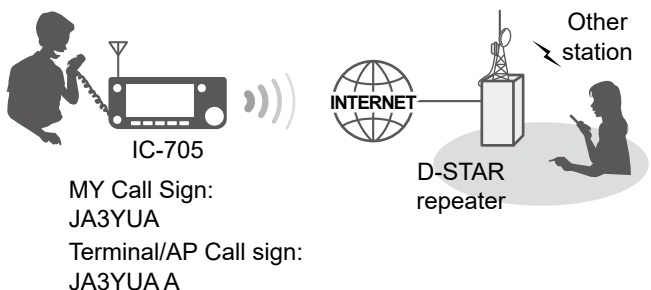

When using the External Gateway function

Enter the Terminal Call sign in “Terminal/AP Call sign” in the RS-MS3W or RS-MS3A.

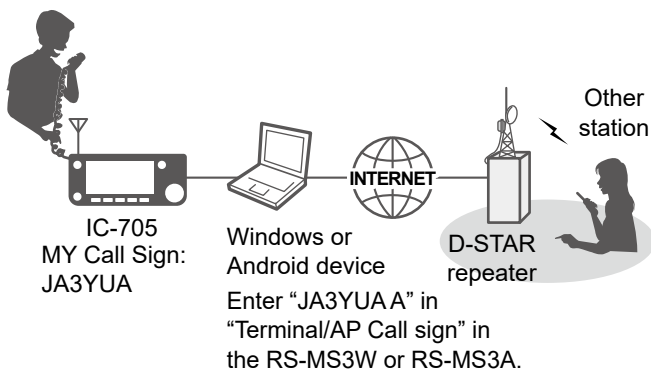

◇ When operating in the AP mode

IMPORTANT:

- Register your call sign (MY) at a gateway server.*
- Register the Terminal/AP call sign that is set in the transceiver, RS-MS3A, or RS-MS3W application software to the RS-RP3C repeater gateway software as the access point.*

* Ask the gateway repeater administrator for details.

① Information

- The Terminal/AP Call sign should be 8 characters long. Enter spaces between Access Point (AP) transceiver’s MY call sign and the 8th character.
- Enter a unique ID suffix between A to Z, except for G, I, and S, at the end of MY Call Sign for the 8th character.
- Call signs shown below are just examples.

When using the Internal Gateway function

Enter the AP Call sign in “Terminal/AP Call sign” in the transceiver. (p. 15-10)

MENU » ② > DV GW > Internal Gateway Settings > Terminal/AP Call sign

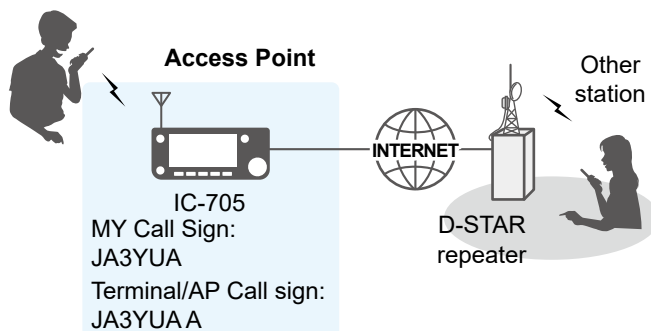

When using the External Gateway function

Enter the AP Call sign in “Terminal/AP Call sign” in the RS-MS3W or RS-MS3A.

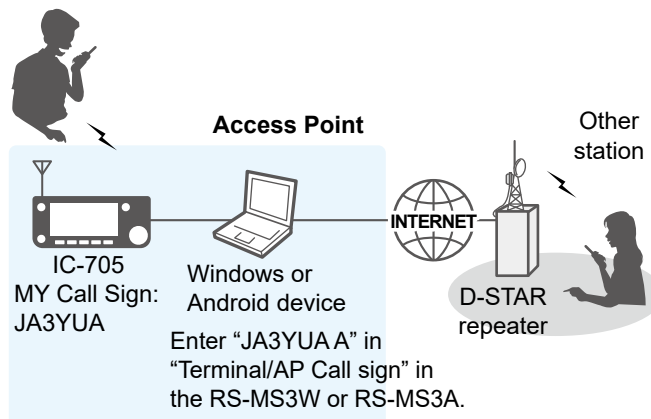

Setting up a network

Before using the DV Gateway function, you have to set up a network.

NOTE: Depending on your contract, you may be charged a large or additional communication fee. Ask your Internet service provider about the content of your contract.

When using the Internal Gateway function

1. When connecting your transceiver to the Internet using a router (p. 15-6)
3. When connecting your transceiver to the Internet using a mobile router (p. 15-9)

When using the External Gateway function

1. When connecting your device*1 to the Internet using a router (p. 15-6)
2. When connecting your device*1 to the Internet using a cellular system (p. 15-8)
3. When connecting your device*1 to the Internet using a mobile router (p. 15-9)

*1 Windows or Android device

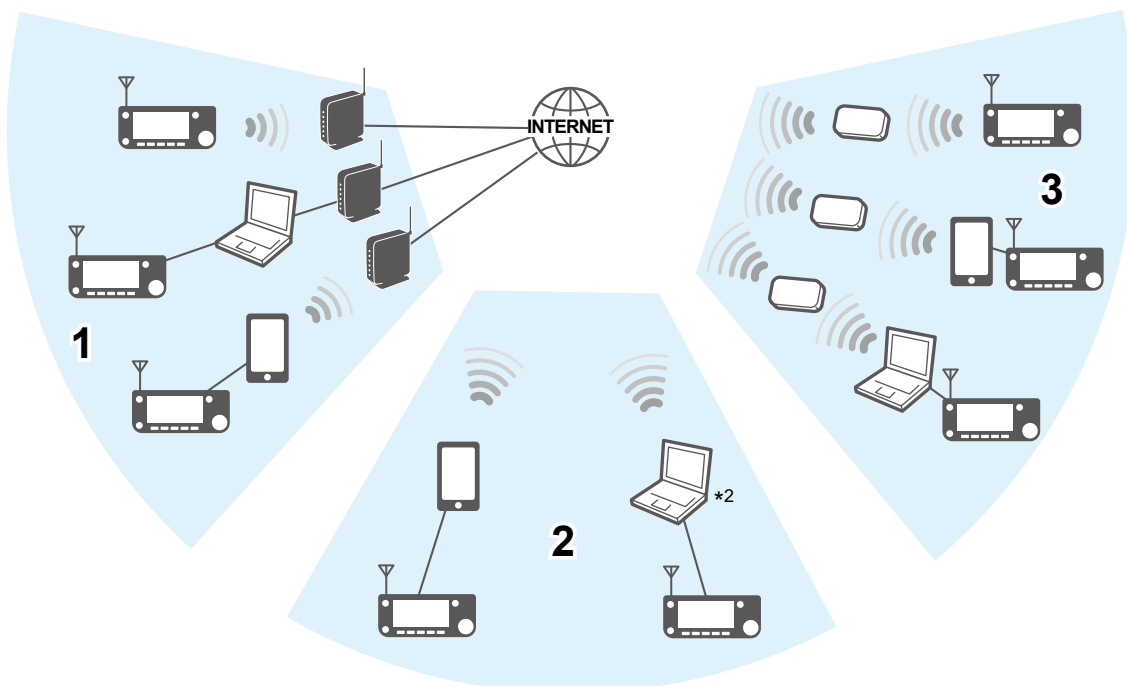

*2 You can use a cellular system compatible computer.

Setting up a network

About the UDP Hole Punch function

When both the caller station and the called station use the Terminal or Access Point mode, the caller station does not need to:

- Forward port 40000 when connecting to the Internet using the router.
- Use a device assigned a static or dynamic Global IP address.

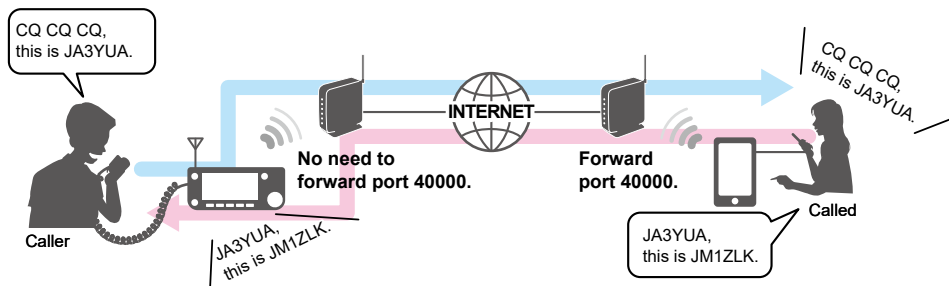

Information

- Depending on your Network environment, you may not be able to use this function.
- The caller station must set “UDP Hole Punch” to “ON” in the IC-705 (When using the Internal Gateway function) or RS-MS3W/RS-MS3A (When using the External Gateway function) to use this function.

MENU » ② > DV GW > Internal Gateway Settings > **UDP Hole Punch**

When not using this function, set “UDP Hole Punch” to “OFF.”

- A few minutes* after the call, the caller station cannot receive from the called station. In this case, the caller station must transmit to the called station again.
- * Less than 3 minutes, depending on the router.

NOTE:

- When using the External Gateway function, use version 1.30 or later of the RS-MS3W/RS-MS3A application software.
- The caller station cannot communicate with the called station when:
 - The caller station is using an earlier version software or firmware.
 - The called station using an earlier version software or firmware.
 - The called station calls through a local repeater instead of using the Terminal or Access Point mode.
- Even if using the latest version, the called station needs to forward port 40000 when connecting to the Internet using a router, or to use a device assigned a static or dynamic Global IP address to communicate with the caller station.

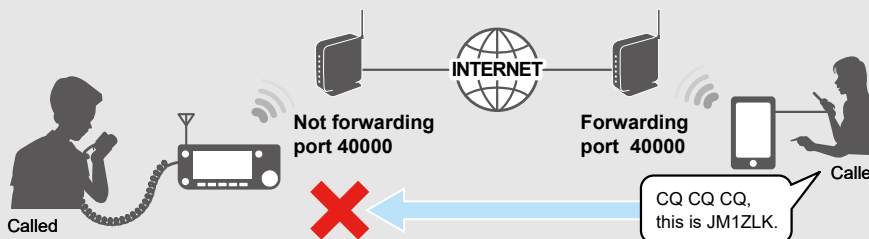

Setting up a network

◇ **When connecting your device to the Internet using a router**

The following items are needed to use the DV Gateway function.

- An Internet connection with an IPv4 Global IP address
- A static*1 local IP address set to your transceiver, Windows, or Android device
- Port forwarding of port 40000

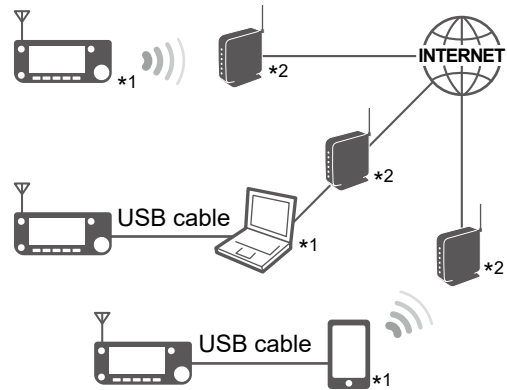

*1 A static IP address to the transceiver, Windows, or Android device is recommended.

*2 Needs a Global IP address and forwarding port number 40000.

1. A Global IP address

A static or dynamic IPv4 Global IP address assigned to the router is needed.

- ① Your router may not have a Global IP address, depending on your Internet service provider. Ask your Internet service provider about the Global IP address setting.

2. Setting a static local IP address

When using a router, you need to set a static local IP address to the transceiver, Windows, or Android device.

- ① Usable IP addresses differ, depending on your router. Ask the router’s manufacturer for details.
- ① Do not set the same IP address to two or more devices that are connected to the same router.
- ① Ask your Windows or Android device’s manufacturer about the setting details.

Transceiver setting

When using the Internal Gateway function, open the CONNECTION SETTINGS screen, and set these items.

MENU » SET > WLAN Set > **Connection Settings**

Items	Contents
DHCP	ON (Default) → OFF
IP Address	An IP address that is not assigned to any other device. Example: 192.168.0.10 (Default)
Subnet Mask	The subnet mask of the IP address Example: 255.255.255.0 (Default) ① Normally, use the default value.
Default Gateway	An IP address of the LAN side on the router Example: 192.168.0.1
Primary DNS Server	An IP address of the DNS Server. ① Normally, enter the default gateway IP address. Example: 192.168.0.1
2nd DNS Server	An IP address of the secondary DNS Server. ① Enter this item if necessary.

15. ABOUT THE DV GATEWAY FUNCTION

Setting up a network

◇ When connecting your device to the Internet using a router

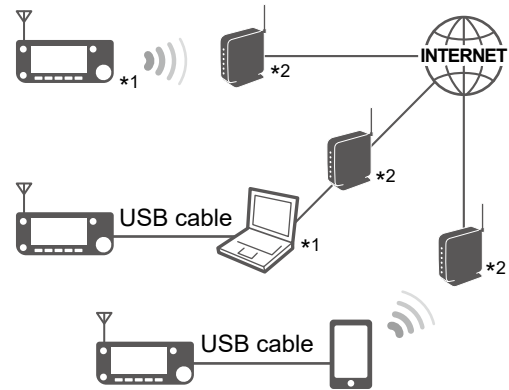

*1 A static IP address to the transceiver, Windows, or Android device is recommended.

*2 Needs a Global IP address and forwarding port number 40000.

3. Port forwarding

When using a router, enable communication with the Internet, as described below.

- Forward the port number 40000 to the transceiver, Windows, or Android device.
- “UDP” should be used as the port protocol.
- Set a static local IP address in Procedure 2 (2. Setting a static local IP address) as a destination port.

① Check the router’s manual about how to forward the port.

① Only one transceiver, Windows, or Android device connected to the router can use the DV Gateway function at the same time.

① Depending on the router settings, you must configure the IP filter settings. Check the router’s manual on how to configure the settings.

→ When using the Internal Gateway function, go to “Setting up the transceiver.” (p. 15-10)

→ When using a Windows device, go to “Setting up the RS-MS3W.” (p. 15-12)

→ When using an Android device, go to “Setting up the RS-MS3A.” (p. 15-13)

15. ABOUT THE DV GATEWAY FUNCTION

Setting up a network

◇ When connecting your device to the Internet using a cellular system

A Global IP address is required to use the DV Gateway function.

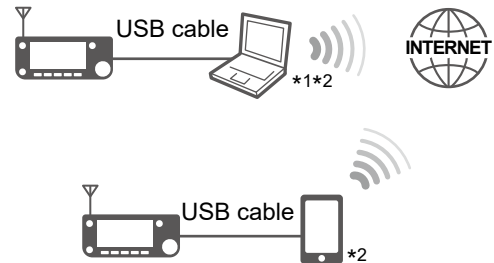

*1 You can use a cellular system compatible computer.

*2 Needs a Global IP address.

A Global IP address

A static or dynamic IPv4 Global IP address assigned to your Windows or Android device is needed. Ask your cellular system company to provide a Global IP address to your device.

NOTE:

- Turn OFF your Wi-Fi setting when you operate using a cellular system.
- Communication errors may occur when using a cellular system.
- Depending on your contract, you may be charged a large or additional communication fee. Ask your cellular service provider about the content of your contract.

→ When using a Windows device, go to “Setting up the RS-MS3W.” (p. 15-12)

→ When using an Android device, go to “Setting up the RS-MS3A.” (p. 15-13)

15. ABOUT THE DV GATEWAY FUNCTION

Setting up a network

◇ When connecting your device to the Internet using a mobile router

The following items are needed to use the DV Gateway function.

- An Internet connection with an IPv4 Global IP address
- A static*¹ local IP address set to your transceiver, Windows, or Android device
- Port forwarding of port 40000

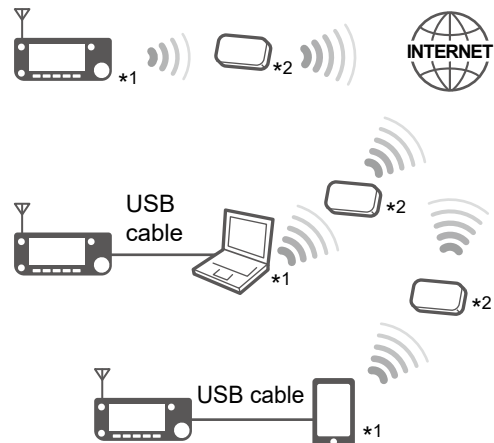

*¹ A static IP address to the transceiver, Windows, or Android device is recommended.

*² Needs a Global IP address and forwarding port number 40000.

1. A Global IP address

A static or dynamic IPv4 Global IP address assigned to the router is needed.

- ① Your router may not have a Global IP address, depending on your Internet service provider. Ask your Internet service provider about the Global IP address setting.

2. Setting a static local IP address

When using a mobile router, you need to set a static local IP address to the transceiver, Windows, or Android device.

- ① Usable IP addresses differ, depending on your router. Ask the router's manufacturer for details.
- ① Do not set the same IP address to two or more devices that are connected to the same router.
- ① Ask your Windows or Android device's manufacturer about the setting details.
- ① See page 15-6 for the transceiver's setting details.

3. Port forwarding

When using a mobile router, enable communication with the Internet, as described below.

- Forward the port number 40000 to the transceiver, Windows, or Android device.
- "UDP" should be used as the port protocol.
- Set a static local IP address in Procedure 2 (2. Setting a static local IP address) as a destination port.
- ① Ask the router's manufacturer about how to forward the port.
- ① Only one transceiver, Windows, or Android device connected to the router can use the DV Gateway function at the same time.
- ① Depending on the router settings, you must configure the IP filter settings. Check the router's manual on how to configure the settings.

→ When using the Internal Gateway function, go to "Setting up the transceiver." (p. 15-10)

→ When using a Windows device, go to "Setting up the RS-MS3W." (p. 15-12)

→ When using an Android device, go to "Setting up the RS-MS3A." (p. 15-13)

Setting up the device

◇When using the Internal Gateway function

Connecting to a router

Turn ON the Wireless LAN function, and connect to a router or a mobile router.

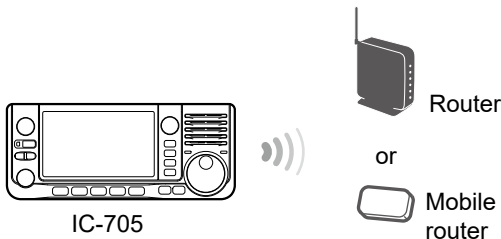

Setting the Internal Gateway Settings

1. Open the INTERNAL GATEWAY SETTINGS screen.

MENU » ② > DV GW > Internal Gateway Settings

2. Touch to select the item to set.
(Example: "Terminal/AP Call sign")

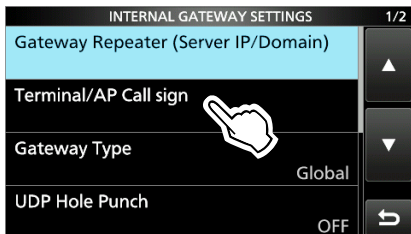

3. Enter a call sign, and then touch [ENT].
① See right for details on the setting items and their options.

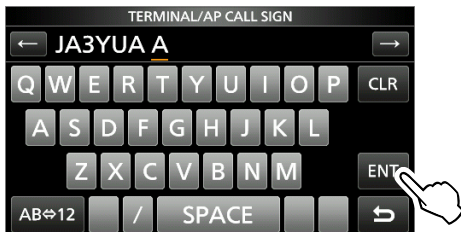

4. To close the INTERNAL GATEWAY SETTINGS screen, push **EXIT** several times.

Gateway Repeater (Server IP/Domain)

Enter the gateway repeater's address or domain name.

① The address consists of up to 64 characters.

NOTE: You must have your call sign registered to a gateway server that has the RS-RP3C installed. Ask the gateway repeater administrator for details.

Terminal/AP Call sign

Enter the Terminal/AP call sign that is registered as the access point on the RS-RP3C's Personal Information screen.

① The call sign should be 8 characters long.

- Enter spaces before the 8th character if necessary.
- Enter a desired ID suffix between A to Z, except for G, I, and S, for the 8th character.

Gateway Type (Default: Global)

Selects the gateway type.

① Select "Global" when operating outside of Japan.

UDP Hole Punch (Default: OFF)

Selects whether or not to use the UDP Hole Punch function. This function enables you to communicate with other station who uses the Terminal or Access Point mode even if you do not forward port 40000 of a router. (p. 15-5)

① Information

- You cannot communicate using this function when the destination station uses the software that is not compatible with the UDP Hole Punch function.
- When forwarding port 40000 of a router, select "OFF."

Setting up the device

◇ When using the Internal Gateway function

Allowed Call Sign (Access Point Mode)
(Default: Disable)

Selects to use the call sign restriction for the Access Point mode. When “Enabled” is selected, this allows only stations with registered call signs to transmit through the Internet.

- Disable: Allows all call signs to transmit.
- Enable: Allows only the call sign entered on the “Allowed Call sign List” to transmit.

① When using the Terminal mode, select “Disabled.”

Allowed Call Sign List

Enter the call sign of the stations that you allow to transmit through the Internet while “Enabled” is selected for “Allowed Call sign (Access Point Mode).”

① You can add up to 30 call signs.

Adding a call sign

1. Touch for 1 second.



2. Touch “Add.”



3. Enter the Call sign, and then touch [ENT].

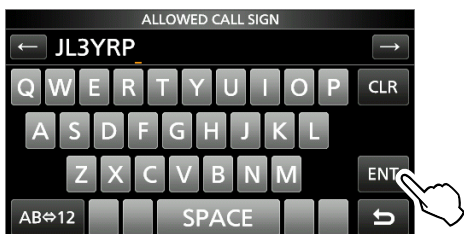

Deleting a call sign

1. Touch the Call sign for 1 second.

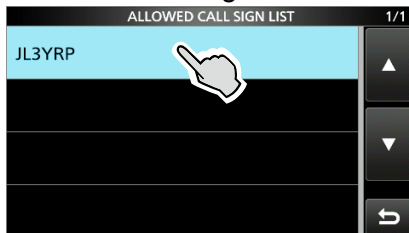

2. Touch “Delete.”

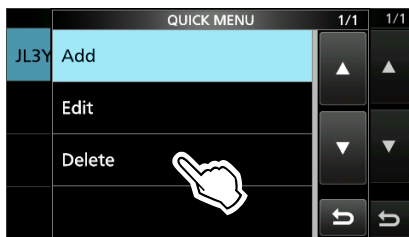

3. Touch [YES].

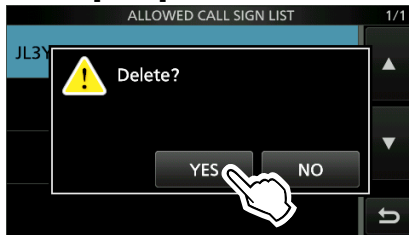

Setting up the device

◇ **When using the RS-MS3W software**

The RS-MS3W is a Windows application to use with the External Gateway function. You can download it from the Icom website.

System requirements

The following are required to use the RS-MS3W. (As of July 2020)

- **Operating System (OS)**
 Microsoft® Windows® 8.1 (32/64bit)
 (Except for Microsoft® Windows® RT.)
 Microsoft® Windows® 10 (32/64bit)
 ① You cannot use Windows Mobile.
- **USB port**
 USB 1.1 or 2.0 port
- **Cable**
 USB cable, depending on your device's USB port.

TIP: Download the USB driver and the installation guide from the Icom website.
<https://www.icomjapan.com/support/>

Installing the RS-MS3W

Download the latest RS-MS3W and its instruction manual from the Icom website. Read the RS-MS3W instruction manual on how to install the software.
 ① Search by "RS-MS3W."
<https://www.icomjapan.com/support/>

Connecting a USB cable

Connect the transceiver to the Windows device using a USB cable.

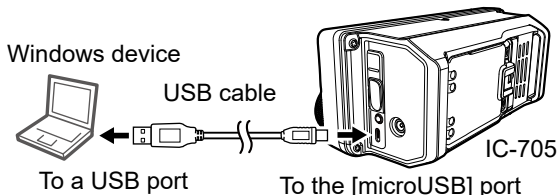

NOTE: Turn OFF the transceiver before connecting or disconnecting the cable.

COM port settings

Set the COM port.

1. After connecting, turn ON the transceiver.
2. Click "Com Port (P)" in the "Settings (S)."
 - The Com Port Setting window is displayed.
3. Select the COM port number that the USB cable is connected to.
 - ① Click "▼" to display the COM ports on a drop-down list.
 - ① See the USB cable's Installation Guide that you can download on the Icom website, for details on checking the COM port number.
4. Click <OK>.

Setting the RS-MS3W

Set the RS-MS3W to start using the DV Gateway function.

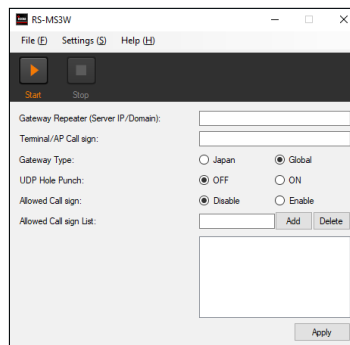

① The screen may be different, depending on the application version.

Read the RS-MS3W instruction manual about each setting item.

NOTE: About the Firewall setting

When you use a firewall security software, a communication error may occur by the firewall blocking the necessary ports or data. Before using the DV Gateway function, confirm that the RS-MS3W's communication is not blocked.

① Ask your firewall security software's manufacturer about the setting details.

Setting up the device

◇ When using the RS-MS3A

The RS-MS3A is an application for Android device to use the External Gateway function. Download the application from Google Play.

- ① Use version 1.30 or later of the RS-MS3A application software

System requirements

The following are required to use the RS-MS3A. (As of July 2020)

- **Android device**
Android 5.0 or later with the USB host function
 - ① The RS-MS3A has been tested with Android 5.x.x, 6.x.x, 7.0, 8.0, 9.0, and 10.0.

TIP: The USB host function is needed to use a USB device with an Android device. To check whether or not your Android device has the USB host system, check the device's instruction manual.

- **Cable** (purchase separately)
OPC-2417 DATA CABLE (USB micro-B/USB micro-B) or
OPC-2418 DATA CABLE (USB micro-B/USB Type-C)

NOTE: Some functions may not be usable, depending on:

- applications installed in the Android device
- memory capacity

For operations or settings of the Android device, read the Android device's instruction manual.
① Display indications may differ, depending on the OS version or settings.

Installing the RS-MS3A

1. Start the Android device.
2. Touch "Play Store."
3. Enter "RS-MS3A."
① Do not abbreviate the application name to search.
4. Touch "🔍 (search)."
5. Touch "RS-MS3A."
• The RS-MS3A application information is displayed.
① If your Android device is not compatible with the RS-MS3A, the application is not displayed.
6. Touch "Install."
7. Touch "Agree to download."
• Starts installing the application.
• After the installation is completed, the icon is displayed on your home screen.

Connecting a USB cable

Connect the transceiver to the Android device using a USB cable.

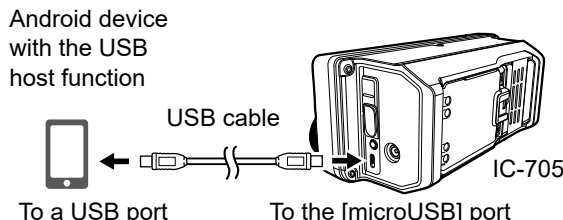

- ① Connect the USB micro-B connector (for the OPC-2417: with the white tube) to the transceiver and the other connector to an Android device.

NOTE:

- Turn OFF the transceiver before connecting or disconnecting the cable.
- When an Android device is connected, the USB connection indicator (USB icon) is displayed on the transceiver. If the indicator is not displayed, enable your Android device to detect the USB device.
- Remove the USB cable when you do not use the cable. Otherwise, the battery will be quickly exhausted.
- If the application selection window is displayed, select "RS-MS3A" to start the application.

Setting the RS-MS3A

Set the RS-MS3A to start using the DV Gateway function.

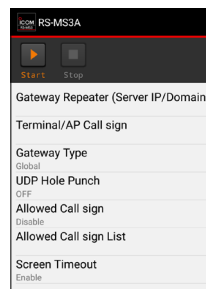

- ① The screen may be different, depending on the application version.

Read the RS-MS3A instruction manual about each setting item.

- ① Search by "RS-MS3A."
<https://www.icomjapan.com/support/>

NOTE: When the Android device does not work properly, try putting the Access Point transceiver at a place far away from the Android device.

Terminal mode operation

◇ Setting the Terminal mode

1. Open the DV GATEWAY screen.

MENU » ② > **DV GW**

2. Touch “<<Terminal Mode>>.”

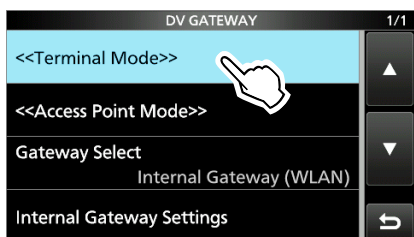

Internal Gateway icon

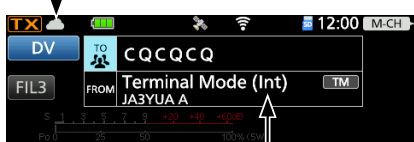

“Ext” is displayed when using the External Gateway function.

When using the External Gateway function

After the transceiver is in the Terminal mode, click (touch) <Start>  in the RS-MS3W or RS-MS3A.

① If an error message is displayed, see page 15-26 for tips on how to solve the problem.

NOTE: In the Terminal mode

- The Power Save function and the Time Out Timer function are not activated.
- The following items are automatically set.
 Operating mode: DV mode*
 DR function: ON*
 FROM: MY Call Sign
 RIT function: OFF
 P.AMP function: OFF
 ATT function: OFF
 * These settings do not return to the previous settings, even if you cancel the Terminal mode.
- The Terminal mode is not automatically canceled, even if you turn OFF the transceiver, then turn it ON again.

TIP: Canceling the Terminal mode









Touch “<<Normal Mode>>” in the DV GATEWAY screen.

MENU » ② > **DV GW** > <<Normal Mode>>

① When using the External Gateway function, click (touch) <Stop>  in the RS-MS3W or RS-MS3A before the transceiver returns to the normal mode.

About the Internal Gateway icon

When using the Internal Gateway function, displays the communication status.

Icon	Status
	In the standby mode
	While transmitting
	While receiving
	Transmission error (The repeater is busy.)
	Transmission error
	Network error
	Receiving while transmitting
	Receive error

① If an error icon is displayed, see page 15-21 to read the tips to solve the problem.

Terminal mode operation

◇ Operating in the Terminal mode

NOTE: In the Terminal mode, you can make a Gateway CQ call, or a call to a specific station, using call sign routing.
 ⓘ You cannot make a call if you select “Local CQ” or “Reflector.”

Example: Making a Gateway CQ call

1. Touch “TO.”

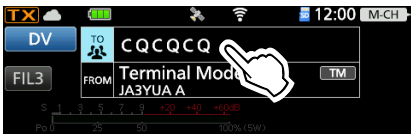

2. Touch “Gateway CQ.”

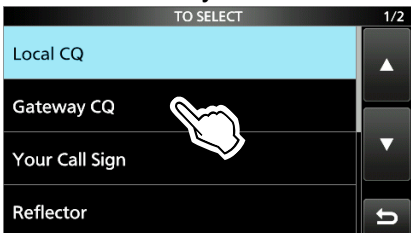

3. Select the repeater group where your destination repeater is listed. (Example: 12: Japan)

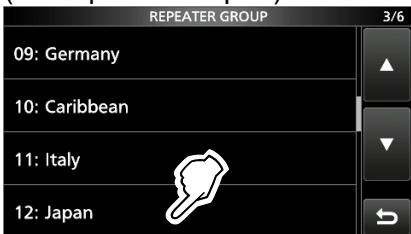

4. Select your destination repeater. (Example: Hirano)



- Returns to the DR screen, and selected repeater name is set in “TO.”

5. Hold down [PTT] to transmit.
 - While transmitting, the TX/RX indicator lights orange.
 - ⓘ While receiving a signal through the Internet, you cannot transmit.

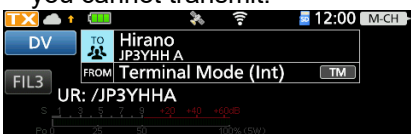

6. Release [PTT] to receive.
 - ⓘ If you do not receive a reply, see page 15-22 for tips on how to solve the problem.

Example: Making a call to a specific station

1. Touch “TO.”

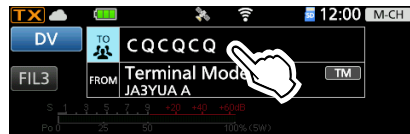

2. Touch “Your Call Sign.”

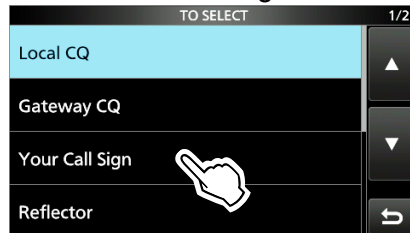

3. Select your destination station. (Example: Rick)

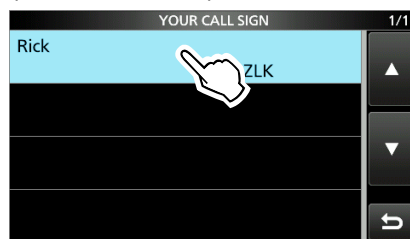

- Returns to the DR screen, and the selected name is set in “TO.”

4. Hold down [PTT] to transmit.
 - While transmitting, the TX/RX indicator lights orange.
 - ⓘ While receiving a signal through the Internet, you cannot transmit.

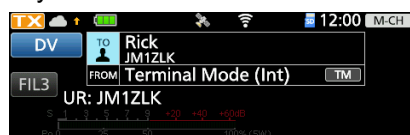

5. Release [PTT] to receive.
 - ⓘ If you do not receive a reply, see page 15-22 for tips on how to solve the problem.

Access Point mode operation

◇ Setting the Access Point mode

In this section, set an Access Point transceiver.

1. Open the DV GATEWAY screen.
MENU » ② > DV GW
2. Touch “<<Access Point Mode>>.”
3. Rotate MAIN DIAL to set the operating frequency.
 - ① The frequency is used to communicate with the Remote D-STAR transceiver.
 - ① In the Access Point mode, you can change the operating frequency.

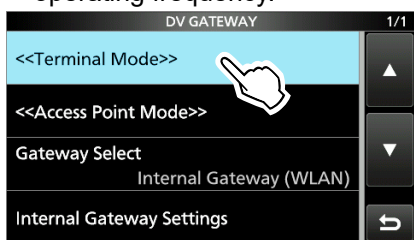

Internal Gateway icon

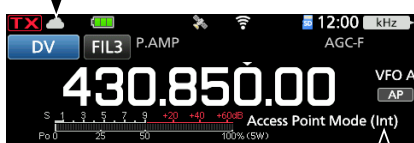

“Ext” is displayed when using the External Gateway function.

NOTE: BE SURE to check your local regulations or laws to select the appropriate operating frequency.

When using the External Gateway function

After the transceiver is in the Access Point mode, click (touch) <Start> in the RS-MS3W or RS-MS3A.

- ① If an error message is displayed, see page 15-26 for tips on how to solve the problem.

NOTE: In the Access Point mode

- The Power Save function is not activated.
- The following items are automatically set.
 - Mode: VFO mode*
 - Operating mode: DV mode*
 - Duplex mode: OFF*
 - RIT function: OFF
 - VOX function: OFF
 - MONITOR function: OFF
- * These settings do not return to the previous settings, even if you cancel the Access Point mode.
- The Access Point mode is not automatically canceled, even if you turn OFF the transceiver, then turn it ON again.

TIP: Canceling the Access Point mode

Touch “<<Normal Mode>>” in the DV GATEWAY screen.

MENU » ② > DV GW > <<Normal Mode>>

- ① When using the External Gateway function, click (touch) <Stop> in the RS-MS3W or RS-MS3A before the transceiver returns to the normal mode.

About the Internal Gateway icon

When using the Internal Gateway function, displays the communication status.

Icon	Status
	In the standby mode
	While transmitting
	While receiving
	Transmission error (The repeater is busy.)
	Transmission error
	Network error
	Receiving while transmitting
	Receive error

- ① If an error icon is displayed, see page 15-21 to read the tips to solve the problem.

Access Point mode operation

◇ Making a Gateway call through the Access Point transceiver

In this section, set up a Remote D-STAR transceiver you are going to operate.

① Read the Remote D-STAR transceiver’s instruction manual for setting details.

NOTE: While in the Access Point mode, you can make a Gateway CQ call or a call to an individual station using call sign routing.
 ① You can select the “Local CQ,” but cannot make a call.

Example: When setting the operating frequency to 430.850 MHz, and making a Gateway CQ call.

Remote D-STAR transceiver*1

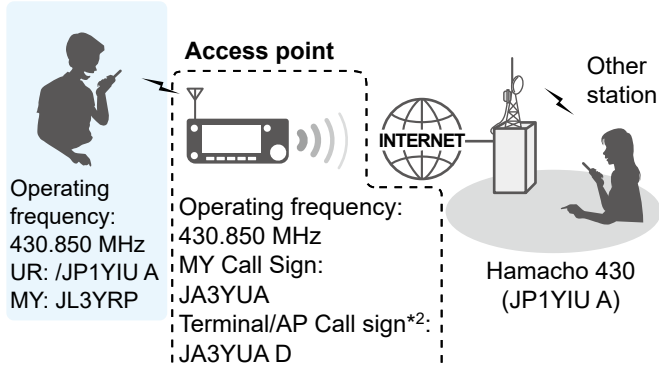

*1 Any model as long as the transceiver is D-STAR capable. Only one D-STAR transceiver can use the Access Point at the same time.

*2 When you use the External Gateway function, enter the Call sign in “Terminal/AP Call sign” in the RS-MS3W or RS-MS3A.

When using the DR function

NOTE: If you have imported the Repeater List, you have to register the Access Point information again because the Repeater List is overwritten.

In this document, the ID-51A (PLUS2)/ID-51E (PLUS2) is used as an example of a Remote D-STAR transceiver.

Step 1. Register the Access Point information to the Repeater List

① Register the Access Point information in the MENU screen.
 (MENU > DV Memory > **Repeater List**)

1. Select a group you want to add your Access Point information to.
2. After selecting a group, open the Repeater List Edit screen. (QUICK MENU > Add)

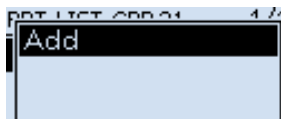

3. Set “TYPE” to “DV Repeater.”
 ① “DV Repeater” is used for Repeater operation in the DV mode.
4. Enter your favorite name into “NAME” and “SUB NAME.” (Example: MY AP)

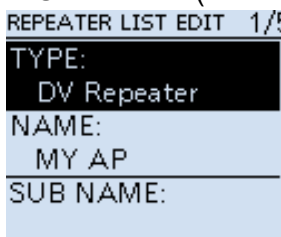

5. Set “CALL SIGN” to the Access Point transceiver’s call sign. (Example: JA3YUA)
 ① After setting “CALL SIGN,” “GW CALL SIGN” is automatically set.

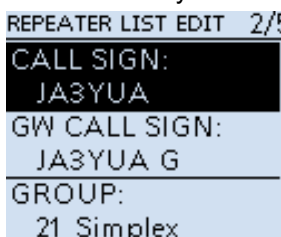

15. ABOUT THE DV GATEWAY FUNCTION

Access Point mode operation

◇ Making a Gateway call through the Access Point transceiver
When using the DR function

Step 1. Register the Access Point information to the Repeater List (Continued)

6. Set "USE (FROM)" to "YES."
7. Set "FREQUENCY" to the Access Point transceiver's operating frequency.
(Example: 430.850)
8. Set "DUP" to "DUP-."

```
REPEATER LIST EDIT 3/5
USE(FROM):
  YES
FREQUENCY:
  430.850.00
DUP:
  DUP-
```

9. Set "OFFSET FREQ" to "0.000.00."

```
REPEATER LIST EDIT 4/5
OFFSET FREQ:
  0.000.00
POSITION:
  None
UTC OFFSET:
  --:--
```

10. Select "<<Add Write>>" and write the Access Point information.

Step 2. Set the Access Point using the DR function

Set the Access Point registered in Procedure 1 (1. Register the Access Point information to the Repeater List) to "FROM."

```
12:00
A DV DUF-
TO CQCQCQ
808
FROM MY AP
430.850 JA3YUA
SLO -----
2019/02/08(Fri)
```

Step 3. Set "TO" and transmit

1. Set "TO" to a destination.
(Example: Hamacho 430)
① You can select the "Local CQ," but cannot make a call.

```
12:00
A DV DUF-
TO Hamacho
808 JP1YIU A
FROM MY AP
430.850 JA3YUA
SLO -----
2019/02/08(Fri)
```

2. Hold down [PTT] to transmit.
3. Release [PTT] to receive.
① If you do not receive a reply, see page 15-24 for tips on how to solve the problem.

15. ABOUT THE DV GATEWAY FUNCTION

Access Point mode operation

◇ Making a Gateway call through the Access Point transceiver

When using the DR function

In this document, the ID-51A (PLUS2)/ID-51E (PLUS2) is used as an example of a Remote D-STAR transceiver.

Step 1. Enter the VFO mode

Push [V/MHz].

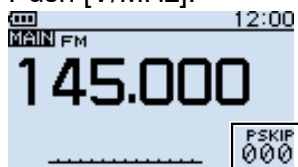

Step 2. Set the operating frequency

Rotate [DIAL] to set the frequency that is set in the Access Point transceiver. (Example: 430.850)

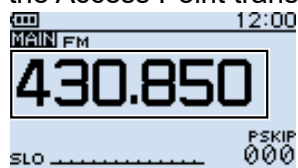

Step 3. Set the Receive mode to "DV mode"

Push [MODE] several times until "DV" is displayed.

①When the "GPS TX Mode" is set, "DV-G" or "DV-A" is displayed.

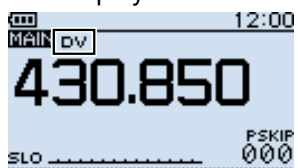

Step 4. Set the duplex direction

1. Push [QUICK].
2. Select "DUP."

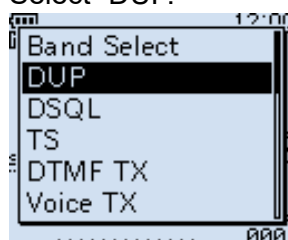

3. Select "DUP-."

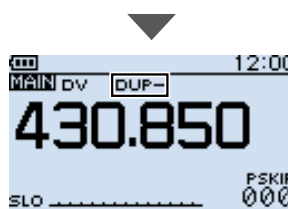
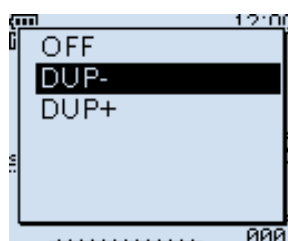

15. ABOUT THE DV GATEWAY FUNCTION

Access Point mode operation

◇ Making a Gateway call through the Access Point transceiver

When using the DR function (Continued)

Step 5. Set the frequency offset

1. Push [MENU].
2. Select "DUP/TONE...."

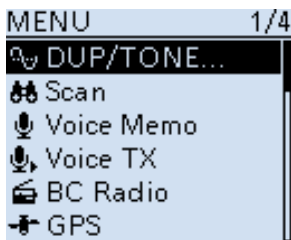

3. Select "Offset Freq."



4. Set to "0.000.00."



5. Push [MENU].
 - Returns to the standby screen.

Step 6. Set "UR" to the destination station call sign

1. Hold down [CS] for 1 second to enter the Operating Call Sign Select mode.
2. Select "UR."
3. Set the destination repeater or destination station's call sign.
 - ① In the Access Point mode, you can select the "CQCQCQ" but cannot make a call.

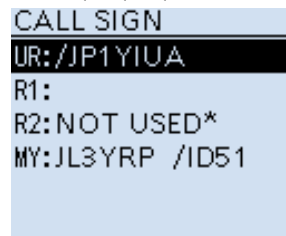

4. Push [MENU].
 - Returns to the standby screen.

7. Hold down [PTT] to transmit





1. Hold down [PTT] to transmit.
2. Release [PTT] to receive.
 - ① If you do not receive a reply, see page 15-24 for tips on how to solve the problem.

TIP: When the settings are saved into a memory channel, you can quickly select them. Read the Remote D-STAR transceiver's instruction manual for details.

Troubleshooting

◇ Error icons of the transceiver

If an error icon is displayed when using the Internal Gateway function, read the following chart. If you are unable to locate the cause of a problem or solve it through the use of this chart, contact your Icom Dealer or Service Center.



Icon	Possible Cause	Solution	REF.
	Transceiver connection is wrong.	Check the connection between the transceiver and the router.	p. 15-10
	Gateway Repeater cannot be found.	Check the WLAN settings.	p. 15-6
	The call sign has not been added to "Allowed Call Sign List" in the transceiver, when "Allowed Call Sign" is set to "Enable."	Set "Allowed Call Sign" to "Disable" in the INTERNAL GATEWAY SETTINGS screen.	p. 15-11
		Add the Remote D-STAR transceiver's call sign to "Allowed Call Sign List" in the INTERNAL GATEWAY SETTINGS screen.	p. 15-11
	Your call sign (MY) has not been registered at a gateway server.	Register your call sign (MY) at a gateway server.	p. 13-4
	The Terminal/AP call sign that is set in the transceiver has not been registered in the RS-RP3C as the access point.	Register the Terminal/AP call sign that is set in the transceiver in the RS-RP3C as the access point.	p. 13-4
	Destination station's call sign (UR) has not been registered to the gateway server, or the call sign do not match your transceiver's setting.	Check the destination station's register information.	—
	Destination station that uses the Terminal mode or Access Point mode does not transmit periodically.	Destination station makes a call.	—
	The repeater is busy.	Wait for a while, and try again.	—
	A signal is received while transmitting.	Destination station makes a call again.	—
	The transceiver cannot receive the signal.	Destination station makes a call again.	—

15. ABOUT THE DV GATEWAY FUNCTION

Troubleshooting

◇ Troubleshooting for the Terminal mode operation

The following chart is designed to help you correct problems which are not equipment malfunctions. If you are unable to locate the cause of a problem or solve it through the use of this chart, contact your Icom Dealer or Service Center.

Problem	Possible Cause	Solution	REF.
After your call, the repeater does not return a status reply.	Transceiver connection is wrong.	When using the Internal Gateway function, check the connection between the transceiver and the router.	p. 15-10
		When using the External Gateway function, check the connection between the transceiver and the Windows or the Android device.	pp. 15-12, 15-13
	“Allowed Call Sign” is set to “Enable.”	When using the Internal Gateway function, set “Allowed Call Sign” to “Disable” in the INTERNAL GATEWAY SETTINGS screen.	p. 15-10
		When using the External Gateway function, set “Allowed Call sign” to “Disable” in the RS-MS3W or RS-MS3A.	RS-MS3W, RS-MS3A's instruction manual
	When using the External Gateway function, you did not click (touch) <Start>  in the RS-MS3W or RS-MS3A.	Click (touch) <Start>  in the RS-MS3W or RS-MS3A.	
After your call, the repeater replies “UR?,” Your own call sign (MY) and ID suffix “G.”	The call was successfully sent, but no station immediately replied.	Wait for a while, and try again.	–
After your call, the repeater replies “RX” or “RPT?” and Your own call sign (MY) and ID suffix “G.”	Your call sign (MY) has not been registered at a gateway server.	Register your call sign (MY) at a gateway server.	–
	The Terminal/AP call sign that is set in the transceiver, RS-MS3A, or RS-MS3W has not been registered in the RS-RP3C as the access point.	When using the Internal Gateway function, register the Terminal/AP call sign that is set in the transceiver in the RS-RP3C as the access point.	p. 13-4
		When using the External Gateway function, register the Terminal/AP call sign that is set in the RS-MS3A or RS-MS3W in the RS-RP3C as the access point.	p. 13-4
	The destination station’s call sign (UR) has not been registered to the gateway server, or the registered contents do not match your transceiver’s setting.	Check the destination station’s register information.	–
	The destination station that uses the Terminal mode or Access Point mode does not transmit periodically.	The destination station makes a call again.	–

15. ABOUT THE DV GATEWAY FUNCTION

Troubleshooting



◇ Troubleshooting for the Terminal mode operation

Problem	Possible Cause	Solution	REF.
After your call, the repeater replies 'RPT?' and the access repeater's call sign.	The repeater cannot connect to the destination repeater.	Wait for a while, and try again.	-
	The repeater is busy.		
"L" appears on the LCD.	While receiving through the Internet, some packets may be lost due to network error (poor data throughput performance).	Wait for a while, and try again. ① When the transceiver receives corrupted data, and misidentifies it as Packet Loss, "L" is displayed.	-
You can transmit, but cannot receive from the destination repeater.	You cannot connect to the Internet, or Global IP address is not assigned.	Check the Internet connection and Global IP address assignment.	p. 15-4
	The router or mobile router's port is not correctly forwarded.	Forward the router or mobile router's correct port to your device.	p. 15-4
	The firewall is blocking the necessary port.	Check your firewall settings.	p. 15-12

Troubleshooting

◇ Troubleshooting for the Access Point mode operation

The following chart is designed to help you correct problems which are not equipment malfunctions. If you are unable to locate the cause of a problem or solve it through the use of this chart, contact your Icom Dealer or Service Center.

Problem	Possible Cause	Solution	REF.
After your call, the repeater does not return a status reply. (No S-meter indication)	The wrong Access Point mode transceiver is selected in the Remote D-STAR transceiver.	Set "FROM" to the correct Access Point mode transceiver.	—
	The manually entered frequency or duplex setting is wrong in the Remote D-STAR transceiver.	Set the correct frequency or duplex setting.	—
	The transmission from the Remote D-STAR transceiver did not reach the Access Point mode transceiver.	Move to a place where the Remote D-STAR transceiver can reach the Access Point mode transceiver.	—
	Transceiver connection is wrong.	When using the Internal Gateway function, check the connection between the transceiver and the router.	p. 15-10
		When using the External Gateway function, check the connection between the transceiver and the Windows or Android device.	pp. 15-12, 15-13
	The Remote D-STAR transceiver's call sign has not been added to "Allowed Call Sign List" in the transceiver, RS-MS3W, or RS-MS3A, when "Allowed Call Sign" is set to "Enable."	When using the Internal Gateway function, add the Remote D-STAR transceiver's call sign to "Allowed Call Sign List" in the INTERNAL GATEWAY SETTINGS screen.	p. 15-11
When using the External Gateway function, add the Remote D-STAR transceiver's call sign to "Allowed Call Sign List" in the RS-MS3W or RS-MS3A.		RS-MS3W, RS-MS3A's instruction manual	
	When using the External Gateway function, you did not click (touch) <Start>  in the RS-MS3W or RS-MS3A.	Click (touch) <Start>  in the RS-MS3W or RS-MS3A.	
After your call, the repeater replies "UR?," the Access Point call sign and ID suffix "G."	The call was successfully sent to the Access Point, but no station immediately replied.	Wait for a while, and try again.	—

15. ABOUT THE DV GATEWAY FUNCTION

Troubleshooting

◇ Troubleshooting for the Access Point mode operation

Problem	Possible Cause	Solution	REF.
After your call, the repeater replies "RX" or "RPT?" and the Access Point call sign and ID suffix "G."	The Remote D-STAR transceiver's call sign has not been set in the transceiver.	Set the Remote transceiver's call sign in the transceiver.	p. 13-3
	The Remote D-STAR transceiver's call sign has not been registered at a gateway server.	Register the Remote D-STAR transceiver's call sign at a gateway server.	p. 13-4
	The Terminal/AP call sign that is set in the transceiver, RS-MS3A, or RS-MS3W has not been registered in the RS-RP3C as the access point.	When using the Internal Gateway function, register the Terminal/AP call sign that is set in the transceiver into the RS-RP3C as the access point.	p. 13-4
		When using the External Gateway function, register the Terminal/AP call sign that is set in the RS-MS3A or RS-MS3W into the RS-RP3C as the access point.	p. 13-4
	The destination station's call sign (UR) has not been registered to the gateway server, or the registered contents do not match your transceiver's setting.	Check the destination station's register information.	–
	A wrong destination repeater's call sign is set to "TO."	Set "TO" to the correct destination repeater's call sign.	p. 15-17
	The transceiver's Internal Gateway settings or the application software settings are wrong.	When using the Internal Gateway function, correctly set the transceiver's Internal Gateway settings.	p. 15-10
		When using the External Gateway function, correctly set the RS-MS3W or the RS-MS3A.	RS-MS3W, RS-MS3A's instruction manual
The destination station that uses the Terminal mode or Access Point mode does not transmit periodically.	The destination station makes a call again.	–	
After your call, the repeater replies 'RPT?' and the access repeater's call sign.	The repeater cannot connect to the destination repeater.	Wait for a while, and try again.	–
	The repeater is busy.		
"L" appears on the LCD.	While receiving through the Internet, some packets may be lost due to network error (poor data throughput performance).	Wait for a while, and try again. ① When the transceiver receives corrupted data, and misidentifies it is as Packet Loss, "L" is displayed.	–
"DV" and "FM" icons alternately blink.	While in the DV mode, an FM signal is received.	Use a different operating frequency until there are no FM signals on the original frequency.	–
You can transmit, but cannot receive from the destination repeater.	You cannot connect to the Internet, or Global IP address is not assigned.	Check the Internet connection and Global IP address assignment.	p. 15-4
	The router or mobile router's port is not correctly forwarded.	Forward the router or mobile router's correct port to your device.	p. 15-4
	The firewall is blocking the necessary port.	Check your firewall settings.	p. 15-12

Troubleshooting

◇ **Error messages of the RS-MS3W and the RS-MS3A**

If an error message is displayed when clicking (touching) <Start>  in the RS-MS3W or RS-MS3A, read the following chart. If you are unable to locate the cause of a problem or solve it through the use of this chart, contact your Icom Dealer or Service Center.

Message	Possible Cause	Solution	REF.
Gateway Repeater (Server IP/ Domain) cannot be found.	The gateway repeater address is not correctly entered.	Correctly enter the gateway repeater address.	RS-MS3W, RS-MS3A's instruction manual
	Your Windows or Android device does not connect to the Internet.	Connect your Windows or Android device to the Internet, and check whether or not you can access to a web site on the www browser.	—
Terminal/AP Call sign is incorrect.	The Terminal/AP call sign is not correctly entered.	Correctly enter the call sign. ① The call sign consists of 8 characters. • Enter a space before the character. • Enter a desired ID suffix between A to Z, except for G, I, and S, for the 8th character.	RS-MS3W, RS-MS3A's instruction manual
The USB cable is not connected. (1 * *)	Transceiver connection is wrong.	Check the connection between the transceiver and the Windows device, or the transceiver and the Android device.	pp. 15-12, 15-13
The USB cable is not connected. (2 * *)	The transceiver is not turned ON.	Turn ON the transceiver.	—
	The transceiver is in the Normal mode.	Enter the Terminal mode or Access Point mode.	pp. 15-14, 15-16
Failed to connect to the network.	The application cannot create a socket for sending and receiving data.	Check whether or not the port number (40000/40002) competes with other application. If so, stop the competing application.	—
		Restart the RS-MS3W or RS-MS3A. If an error message does not disappear, restart Windows or Android device.	—
A Network error occurred.	System error occurs when receiving data from a network.	Restart the RS-MS3W or RS-MS3A. If an error message does not disappear, restart Windows or Android device.	—
Failed to start the service.	The gateway repeater address or Terminal/AP call sign is not correctly entered.	Correctly enter the gateway repeater address or Terminal/AP call sign.	RS-MS3W, RS-MS3A's instruction manual
	System error occurs when the service started.	Restart the RS-MS3W or RS-MS3A. If an error message does not disappear, restart Windows or Android device.	—

16. MAINTENANCE (ADVANCED)

Cloning

The IC-705 has a data cloning capability. This function is useful when you want to copy all of the settings and entered contents from one IC-705 to another. This section describes the cloning method using a microSD card.

- ① Recorded voice memories are not included in the cloning data. To play back the master transceiver's voice memory, insert the microSD card into a sub transceiver, or make a copy onto the sub transceiver's microSD card using a PC.
- ① Assumes that the microSD card has already been inserted into the transceiver.

Step 1. Saving the master transceiver's setting data onto the microSD card.

1. Open the SAVE SETTING screen.
MENU » **SET > SD Card > SD Card**

2. Touch "<<New File>>."



- ① The file name is automatically set in the following format: Setyyyyymmdd_xx (yyyy: Year, mm: month, dd: day, xx: serial number).
3. To save the file with the displayed name, touch [ENT].

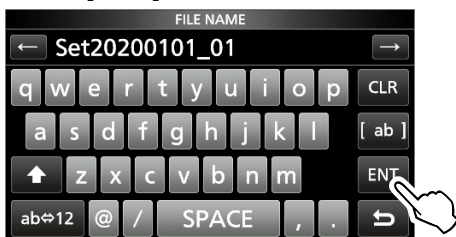

- ① To change the name, delete the name, reenter it, and then touch [ENT].
4. Touch [YES].

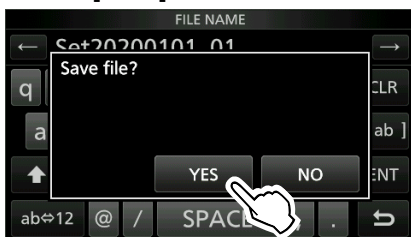

- Saves the contents and settings.
5. To close the SD CARD screen, push **EXIT** several times.

Step 2. Remove the microSD card from the master transceiver, then insert it into the sub transceiver.

1. Turn OFF the master transceiver.
2. Remove the microSD card from the master transceiver.
3. Insert the card into the sub transceiver, then turn ON the sub transceiver.

NOTE:

- Turn OFF the transceiver before you insert or remove the microSD card.
- **DO NOT** turn OFF the transceiver while saving or loading the setting data. Otherwise, the data may be corrupted or deleted.

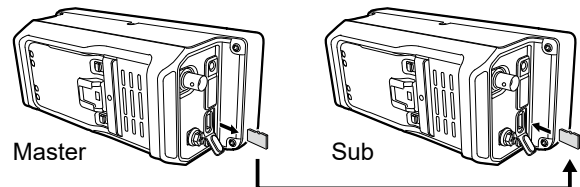

TIP: The setting data is saved in the "icf" file format that is used in the CS-705 PROGRAMMING SOFTWARE.

When the saved data on a card is copied to a PC, you can edit it with the programming software.

For details, refer to the CS-705 instructions that can be downloaded from the Icom website.

(Continue the steps on the next page.)

Cloning

Step 3. Loading the setting data into the sub transceiver.

1. Open the LOAD SETTING screen.

MENU » **SET > SD Card > Load Setting**

2. Touch the file to load.

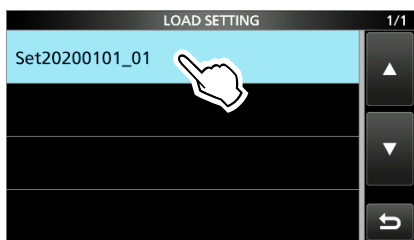

3. Touch "Select."

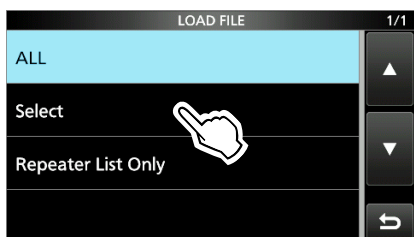

- ① If you want to load all the contents on the LOAD OPTION screen, touch "ALL," then go to step 6.
- ① If you want to load only the repeater list, touch "Repeater List Only," then go to step 6.

4. Touch the loading options.
(Example: CI-V Address)

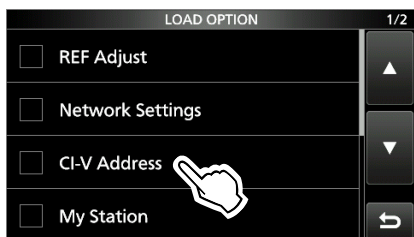

- "✓" is displayed on the left side of the selected option.
- ① The Set mode settings and Memory channel contents are always loaded.

5. Touch "<<Load>>."

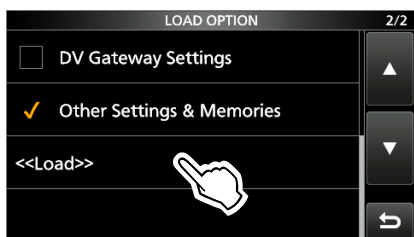

6. Touch [YES] or [NO].

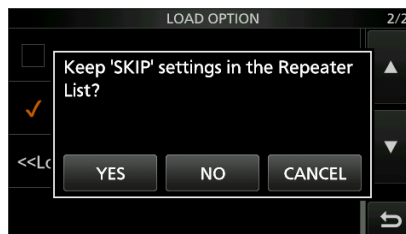

- ① When you touch [YES], the Skip settings on the repeater list are retained.
- ① When you touch [NO], the Skip settings on the repeater list are cleared.

7. Touch [YES].

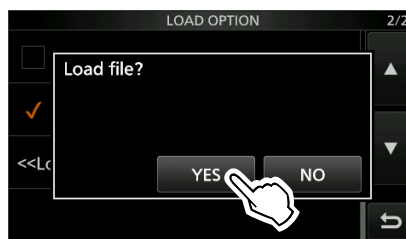

- After the loading ends, "COMPLETED! Restart the IC-705." is displayed.
 - ① When you select "REF Adjust" in step 4, "The new "REF Adjust" setting will be saved" is displayed.
8. Turn the OFF transceiver power, and then turn it ON again to restart the transceiver.

Touch screen calibration function

When the screen does not respond, or the transceiver does not work correctly after touching the screen, the touched point and the detected point may be different.

In that case, the Touch screen calibration function helps to correct the touch screen sensing accuracy.

1. Open the OTHERS screen.

MENU » **Others**

2. Touch "Touch Screen Calibration."

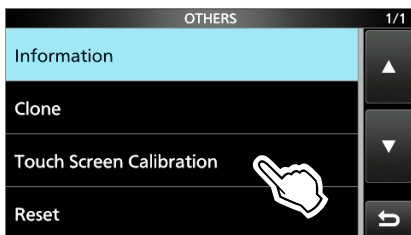

- A dot appears on the screen.

3. Touch the dot that is displayed on the screen.

Touch the displayed dot.

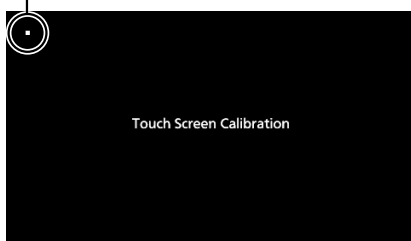

- A new dot appears in another location.

4. Repeat step 3.

- When the calibration is complete, the transceiver returns to the OTHERS screen.

TIP: When the touch screen is not accurate, and you cannot access the OTHERS screen.

Do the following steps to display the "Touch Screen Calibration" screen.

1. Turn OFF the transceiver.
2. While holding down **MENU** and **EXIT**, push **POWER** to display the "Touch Screen Calibration" screen.
3. Repeat steps 3 and 4 in the left column.
4. Touch the frequency readout or a key on the touch screen to confirm that the touch screen is working correctly.

17. UPDATING THE FIRMWARE

General

◇ About updating the firmware

You can update the IC-705's firmware using a microSD card. Updating the firmware adds new functions and/or improves performance parameters.

You can download the latest firmware from the Icom website.

<https://www.icomjapan.com/support/>

IMPORTANT: To update the firmware, first format your microSD card using the IC-705. Then copy the downloaded firmware data from your PC into the "IC-705" folder on the card.

◇ Checking the firmware version

Check the firmware version when you turn ON the transceiver.

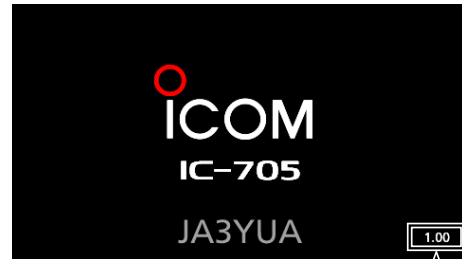

The firmware version is displayed.

TIP: You can also check the firmware version on the VERSION screen.

MENU » **SET > Others > Information > Version**

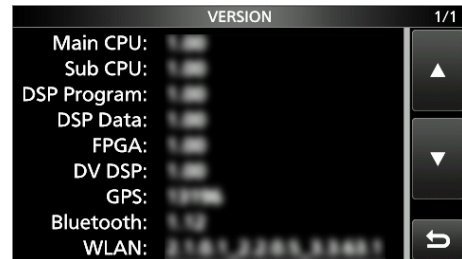

17. UPDATING THE FIRMWARE

General

◇ Preparation

Access the following URL and download the firmware file.

<https://www.icomjapan.com/support/>

① These instructions are based on Microsoft® Windows® 10.

1. Click the “Firmware/Software” link.

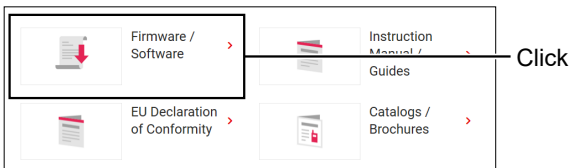

2. Enter “IC-705” into the Search box, and then click [Search].

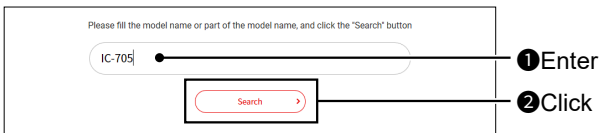

3. Click the desired firmware file link.

4. Carefully read “Regarding this Download Service.” Click “Agree,” and then click [Download].

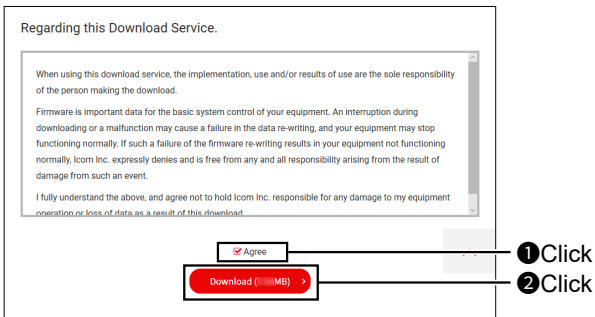

5. Click “Save as” in the displayed File Download dialog.

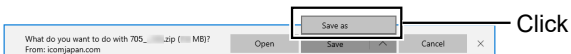

6. Select the location where you want to save the firmware, and then click [Save] in the displayed File Download dialog.

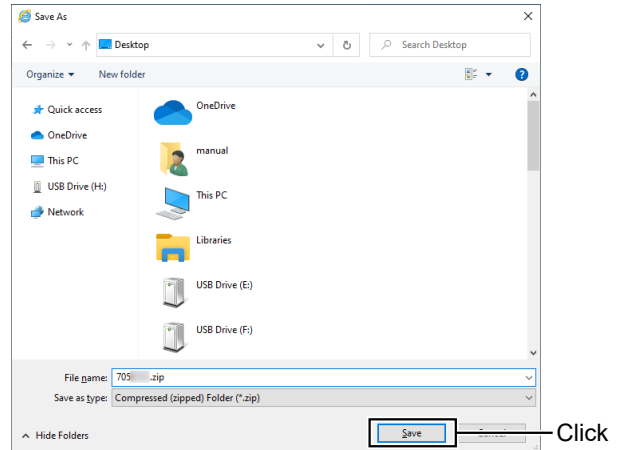

- The file starts downloading.
- The firmware and the firm utility are compressed in a “zip” format folder. Unzip it before use.

◇ Unzipping the firmware folder

1. Right-click the downloaded firmware folder (zip format).
 - The right-click menu is displayed.
2. Click “Extract All...”



- After unzipping, a folder is created in the same location as the downloaded folder.

① In the “705*” folder, “705*.dat” is created.

* Represents the release number.

Updating the firmware

CAUTION: NEVER turn OFF the transceiver while updating the firmware. If you turn OFF the transceiver, or if a power failure occurs while updating, the transceiver firmware will be damaged, and you will have to send the transceiver back to the nearest Icom distributor for repair. This type of repair is out of warranty, even if the transceiver warranty period is still valid.

Recommendation!
Fully charging of battery pack before starting the firmware update is strongly recommended. This is to avoid failure during the update, caused by an unexpected power failure.

TIP: BE SURE to unzip the downloaded file. See the previous page for details.

1. Copy the downloaded firmware data into the "IC-705" folder on to a microSD card.

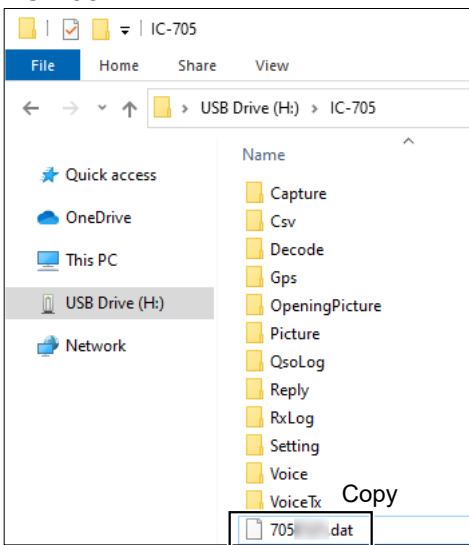

2. Insert the microSD card into the transceiver.
3. Display the SD CARD screen.
MENU » **SET > SD Card**
4. Touch "Firmware Update."

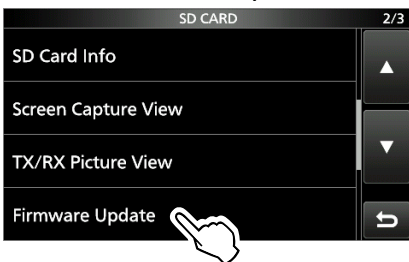

5. After you read and agree with all the precautions, touch [YES].

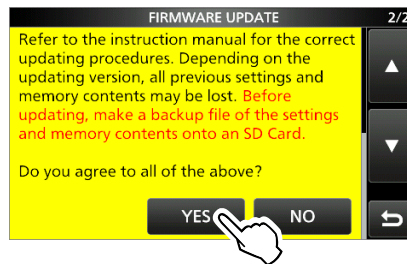
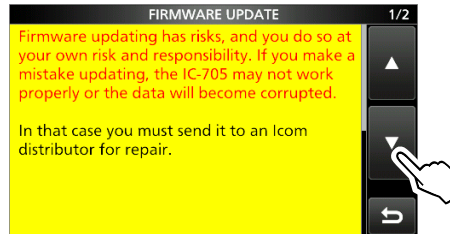

- Scroll the screen and read all the precautions.
- The confirmation dialog is displayed. When you touch [YES], the backup file is made on the microSD card, and then the Firmware selection screen is displayed.

6. Touch the Firmware (Example: 705*).
* Represents the release number.

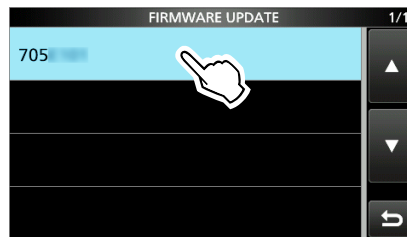

- The final confirmation screen is displayed. Carefully read all the displayed precautions.
7. After you read and agree with all the precautions, touch [YES] for 1 second.

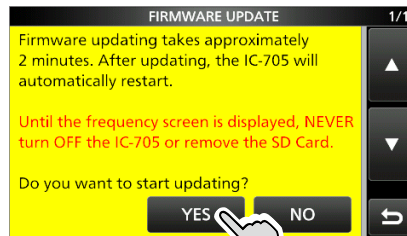

Touch for 1 second

- The updating starts.
8. When the update is completed, "Firmware updating has completed." is displayed in the dialog.
 - The transceiver will automatically restart.
- ①After the updating finishes, the operating screen is displayed.

18. ADVANCED CONNECTIONS

FSK and AFSK connections

The transceiver has a mode key for RTTY. You can use a PC and an application software to operate RTTY using a USB cable. See the interface circuit diagram below for details.

Refer to the software application's instruction manual for setup details.

(Icom does not guarantee the performance of the application software, PC, network device, or network settings.)

When using the microUSB port

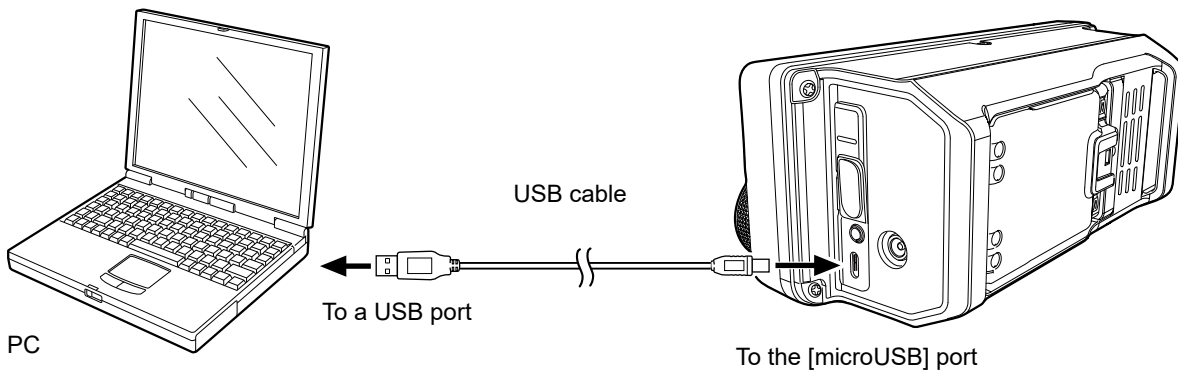

TIP:

- To operate RTTY through your PC's USB port, set the following item.
[MENU] » [SET > Connectors > USB SEND/Keying]
- Download the USB driver and the installation guide from the Icom website.
<https://www.icomjapan.com/support/>

When using the [SP] jack, [MIC] jack, and [SEND/ALC] jack

Interface circuit example for digital modes (User supplied)

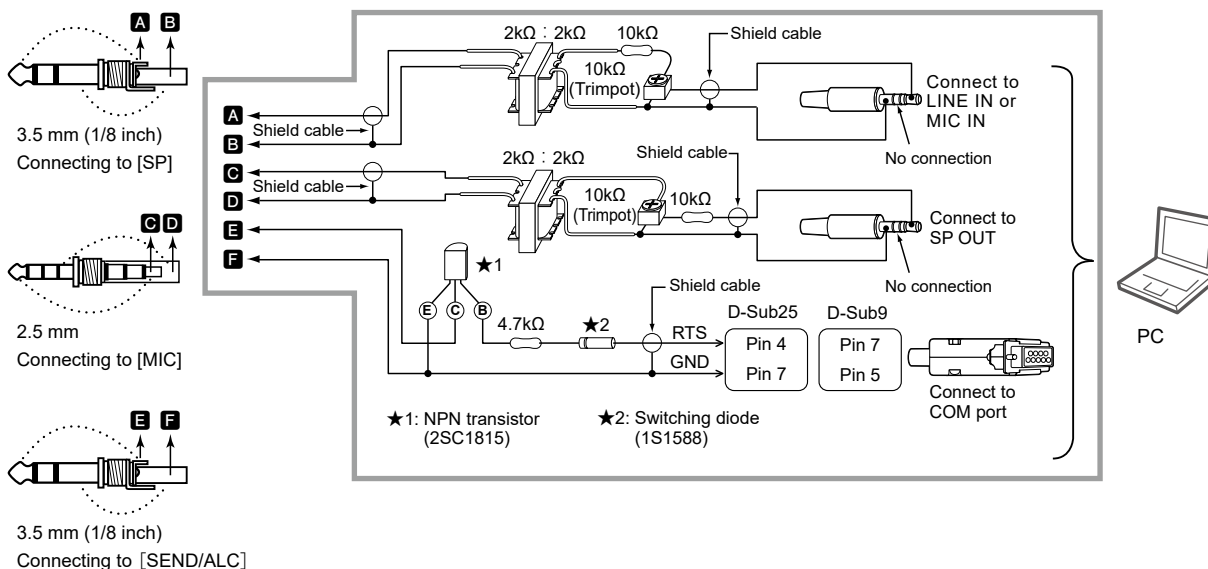

TIP: We recommend using the SEND terminal on the [SEND] jack to change receiving and transmitting. If you use the PTT terminal on the [MIC] jack, the data may be cut off.

Count on us!

