



INSTRUCTION

MANUAL

FT 227R *A*

MEMORIZER

YAESU MUSEN CO LTD.

OKYO JAPAN

TABLE OF CONTENTS

	(Page)
GENERAL	.. 1
SPECIFICATIONS	4
INSTALLATION 5
CONTROLS & SWITCHES	8
REAR PANEL	10
OPERATION 11
BLOCK DIAGRAM	13
THEORY OF OPERATION	14
MAINTENANCE & ALIGNMENT 21
PARTS LIST	30
TRANSISTOR & IC CONNECTIONS	35
PROGRAMMABLE DIVIDER CODE 36

FT-227-R MEMORIZER
2 METER FM TRANSCEIVER



GENERAL

The model FT-227R is a new synthesized 2 meter FM transceiver specifically designed to provide high performance for amateur VHF/FM communications.

The transceiver utilizes the famed Yaesu computer theory, and is completely solid state. The unit has provision for the operation of 800 digital Phase Lock Loop channels* in 5 kHz steps between 144 to 148 MHz. An "optical coupling" system eliminates rotary switches which always used to get oxidized and noisy. The digital LED's display the selected channel in MHz, 100 kHz, and 1 kHz. The bright display lets you easily read the frequency in the bright sunlight without difficulty.

A memory circuit memorizes any channel out of 800 channels. A touch of a switch brings you back to the memorized channel instantly.

In addition to a conventional ± 600 kHz repeater split, any transmitter offset frequency is memorized with a touch of a push-button for operation on any ODD split frequency repeater.

The tone burst generator is built in for tone burst accessed repeater operation, and is fully adjustable for pitch, duration and level.

An optional tone guarded squelch (TGS) is provided for a silent monitoring. Placed in the TGS mode, a tone guarded signal automatically opens the receiver squelch circuit. The tone frequency can be selected within 160 Hz to 250 Hz.

The BUSY lamp lights up if the channel is occupied by another station when the tone guarded squelch is in use. This also works as an alarm when the receiver volume is accidentally set too low.

The advanced circuit design features prevent damage to the transistors in case of high antenna VSWR, or reversed power supply polarity.

The FT-227R is manufactured with a high regard for quality, utilizing a diecast front panel and a heavy gauge metal case which provides an extremely rugged package which minimizes the effects of shock and vibration.

* Channels can be limited to 400 within either 144-146 MHz or 146-148 MHz.

The FT-227R VHF/FM transceiver is supplied complete with all mounting hardware, cables, connectors and accessories required for a mobile installation, as shown in Figure 1.

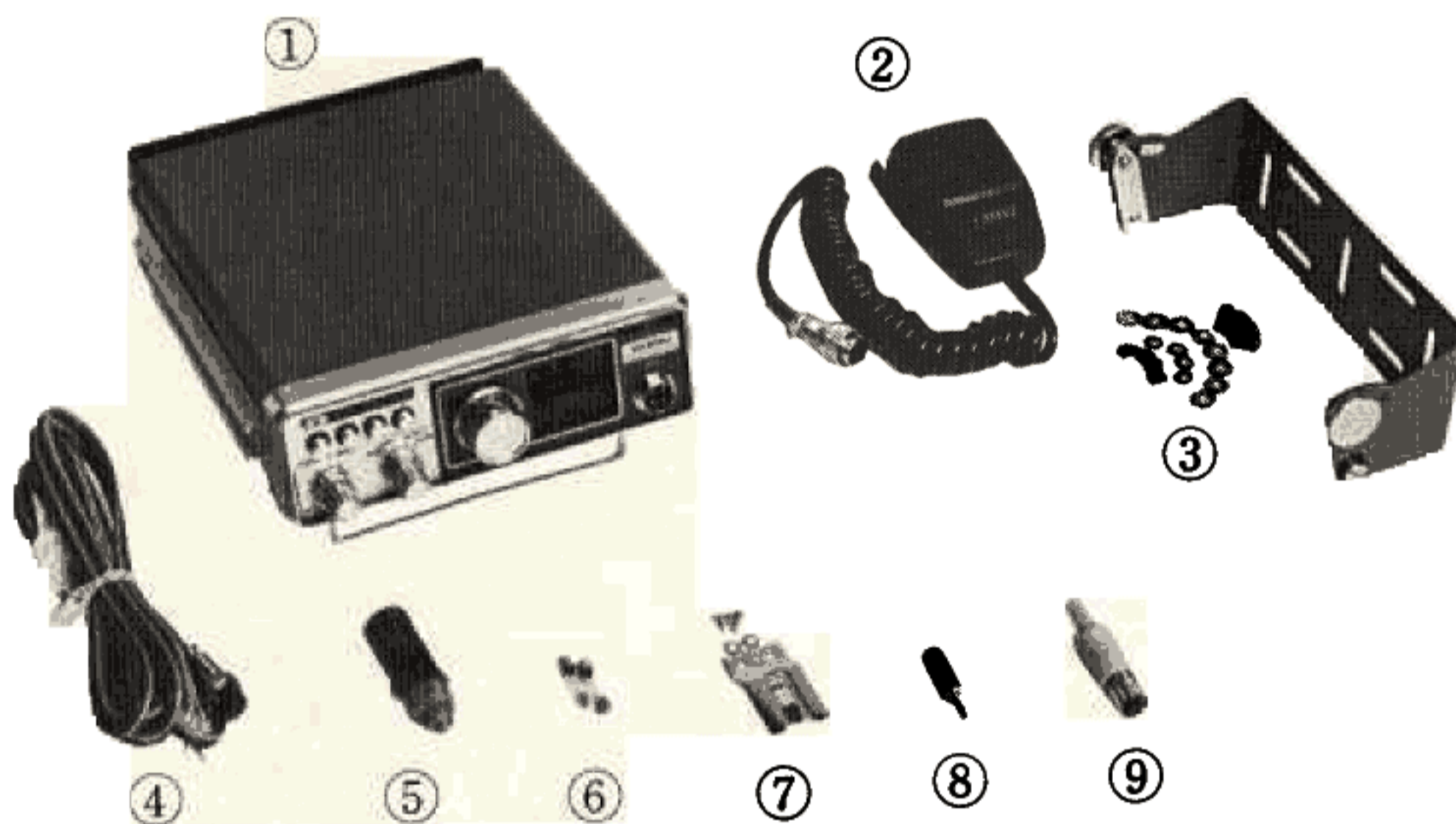

Figure 1.

1. Transceiver with built-in 3" speaker
2. Dynamic push-to-talk microphone with retractable coiled cord.
3. Universal mounting bracket (with screws, washers and nuts).
4. Power cable.
5. Cigarette lighter adapter.
6. Spare fuses
7. Microphone hanger
8. Miniature phone plug for external speaker.
9. Accessory plug.
10. Tap connector.

HOW TO USE THE TAP CONNECTOR

- (a) Do NOT strip insulation from wires.
- (b) The tap connector will handle most wire sizes used in automotive instrument panels.
- (c) Slice the "hot" lead into tap connector as shown.
- (d) Insert transceiver power lead 3/4 of the way into connector (just past metal connector element).
- (e) Using pliers, press the metal connector element until it is FLUSH.
- (f) Fold the hinged cover over the connector element and snap firmly in place.

Plastic Insulator
with hinged
"snap-in" cover

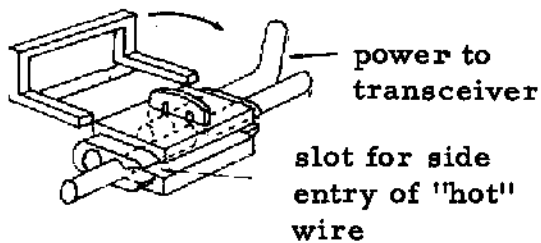

Connection made
with any pliers
type tool by driving
element over wires

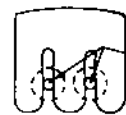

wires

Self-stripping "U"
type spring pressure
connector element

Figure 2

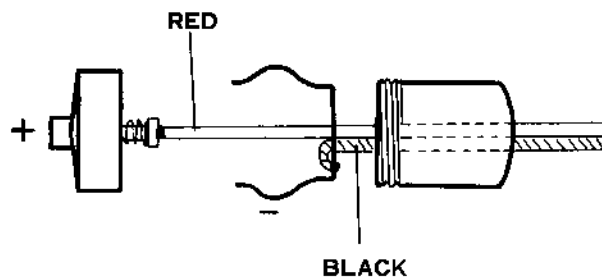

Figure 3.

The compact design of the FT-227R transceiver makes it ideal for mobile installation, operating directly from the vehicle's 12 Volt battery. For base station, use AC Power Supply rated 2.5 ampere at 13.8 V DC.

SPECIFICATIONS

GENERAL

Frequency Coverage	144 to 148 MHz*
Number of Channels	800 channels*
Speaker	Internal 3" dynamic speaker with provision for connecting an external 8 ohm dynamic speaker
Microphone	Dynamic push-to-talk microphone with retractable coiled cord.
Power Requirement	13.8 Volts DC, $\pm 10\%$
Current Consumption	0.5 Amps Receive 1.0 Amps Transmit (LOW) 2.5 Amps Transmit (HI)
Metering	Illuminated front panel meter indicates relative received signal strength and transmitter power output
Dimensions	180 (W) x 60 (H) x 220 (D) mm
Weight	2.7 kg

TRANSMITTER

RF Output	10 Watts (HI) or 1 Watt (LOW) into 50 ohms load at 13.8 Volts DC
Frequency Stability	$\pm 0.002\%$
Modulation	F3
Deviation	± 5 kHz
Audio Response	+1, -3 dB of 6 dB/Octave pre-emphasis characteristic from 300 to 2500 Hz
Spurious Emissions	60 dB below carrier minimum
Tone Burst	Nominally one second at 1800 Hz
Repeater Split	± 600 kHz or any frequency in 5 kHz increments

RECEIVER

Type	Double conversion super-heterodyne
Intermediate Frequency	10.7 MHz first IF: 455 kHz second IF
Sensitivity	0.3 μ V for 20 dB quieting
Selectivity	\pm 6 kHz at 6 dB; \pm 12 kHz at 60dB
Audio Output	1.5 Watts at 8 ohms

INSTALLATION

GENERAL

The model FT-227R transceiver is designed primarily for mobile service, requiring only an antenna and a 13.8 Volt DC power source for operation.

The transceiver has been factory pre-tuned and requires no adjustments for normal operation into a 50 ohm load.

The antenna location is the most important consideration in either a base or mobile installation, with effective communication range directly related to antenna height. The antenna should always be in the clear and as high as possible; however, a minimum distance of 5 feet should be maintained between the VHF and other antennas. Also, in mobile installation, it is advisable to locate the antenna as far from the engine as practical, in order to minimize ignition noise pick-up. In all installations, ensure that the antenna VSWR is less than 1.5:1.

For mobile installation, the popular antenna types are either a 1/4 wave length whip with unity gain, or a 5/8 wave length affording approximately 3.5 dB gain. Mobile antennas are available at your dealer.

To minimize losses in the antenna system, use the shortest length of coaxial cable that is practical, avoiding any sharp angles or kinks. Use type RG-8/U cable if the transmission line length exceeds 25 feet, while RG-58U is suitable for shorter lengths. For all bends, form the cable into a radius of not less than 10 times its diameter.

MOBILE INSTALLATION

For mobile service, the FT-227R should be installed where the controls, indicators, and microphone are easily visible and accessible for operation. The unit may be mounted in any position without loss of performance. Suitable locations are under the dash, atop transmission tunnel, etc. A universal bracket is supplied with the transceiver for this purpose. Install the FT-227R as follows (refer to figure 4).

1. Use the universal mounting bracket as a template to locate the mounting holes. Use a 3/16" diameter drill for these holes and allow clearance for the transceiver, its controls, and connecting cables. Secure the mounting bracket with the screws, washers and nuts supplied, as shown in '4A.'
2. Install the transceiver in the mounting bracket, sliding it into the guide rail of the bracket, and tighten the screws on both sides.
3. Microphone hanger may be affixed to any convenient place for handling the microphone.

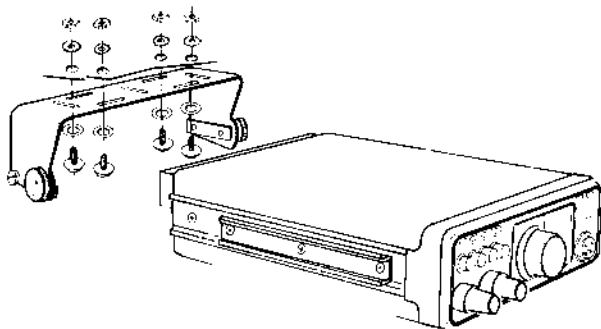

Figure 4 A.

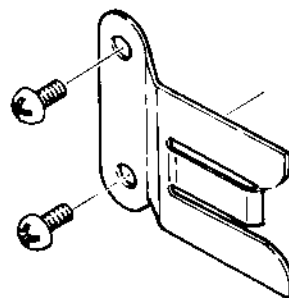

Figure 4 B.

4. The supplied power cable may be plugged directly into the vehicle's cigarette lighter receptacle for casual operation if desired. For permanent installation, the lighterplug may be removed and the leads routed directly to the battery (red positive, black negative or ground), or the nearest termination to the battery, i.e. ignition switch, fuse block, etc. If it is necessary to extend the power leads, use #16AWG insulated copper wire and do not extend the leads further than required to avoid excessive voltage drop. The frequency will shift to 147.000 MHz or 147.005 when the supply voltage is accidentally opened by a loose contact of the power adaptor.

CAUTION

BEFORE CONNECTING THE POWER CABLE TO THE TRANS-CEIVER, CHECK THE BATTERY VOLTAGE WITH THE ENGINE RUNNING (BATTERY CHARGING). IF THE VOLTAGE EXCEEDS 15 VOLTS DC, THE REGULATOR SHOULD BE READJUSTED SO THE HIGHEST CHARGING RATE DOES NOT EXCEED 15 VOLTS. ALSO, BE SURE TO OBSERVE PROPER POLARITY WHEN MAKING BATTERY CONNECTIONS (REVERSED POLARITY WILL NOT DAMAGE THE FT-227R DUE TO THE PROTECTIVE CIRCUITRY INCORPORATED IN THE DESIGN, HOWEVER, THE EQUIPMENT WILL NOT OPERATE UNDER THIS CONDITION).

5. Connect the power cable to the POWER receptacle on the rear panel.
6. Connect the 50 ohm antenna cable to the ANT receptacle on the rear panel.
7. Connect the microphone cable to the 4-pin microphone receptacle on the front panel.
8. An external 8 ohm speaker may be connected at the SP receptacle on the rear panel if desired (this automatically disconnects the internal speaker). Use the external speaker plug supplied.

BASE STATION INSTALLATION

As a base station, the FT-227R requires a source of 13.8 Volts DC at 2.5 amperes.

CONTROLS & SWITCHES

The FT-227R has been designed for ease of operation. However, the operator may not be familiar with some controls since it utilizes modern computer technology. Be sure you thoroughly understand the function of each control and indicator before operating the equipment.

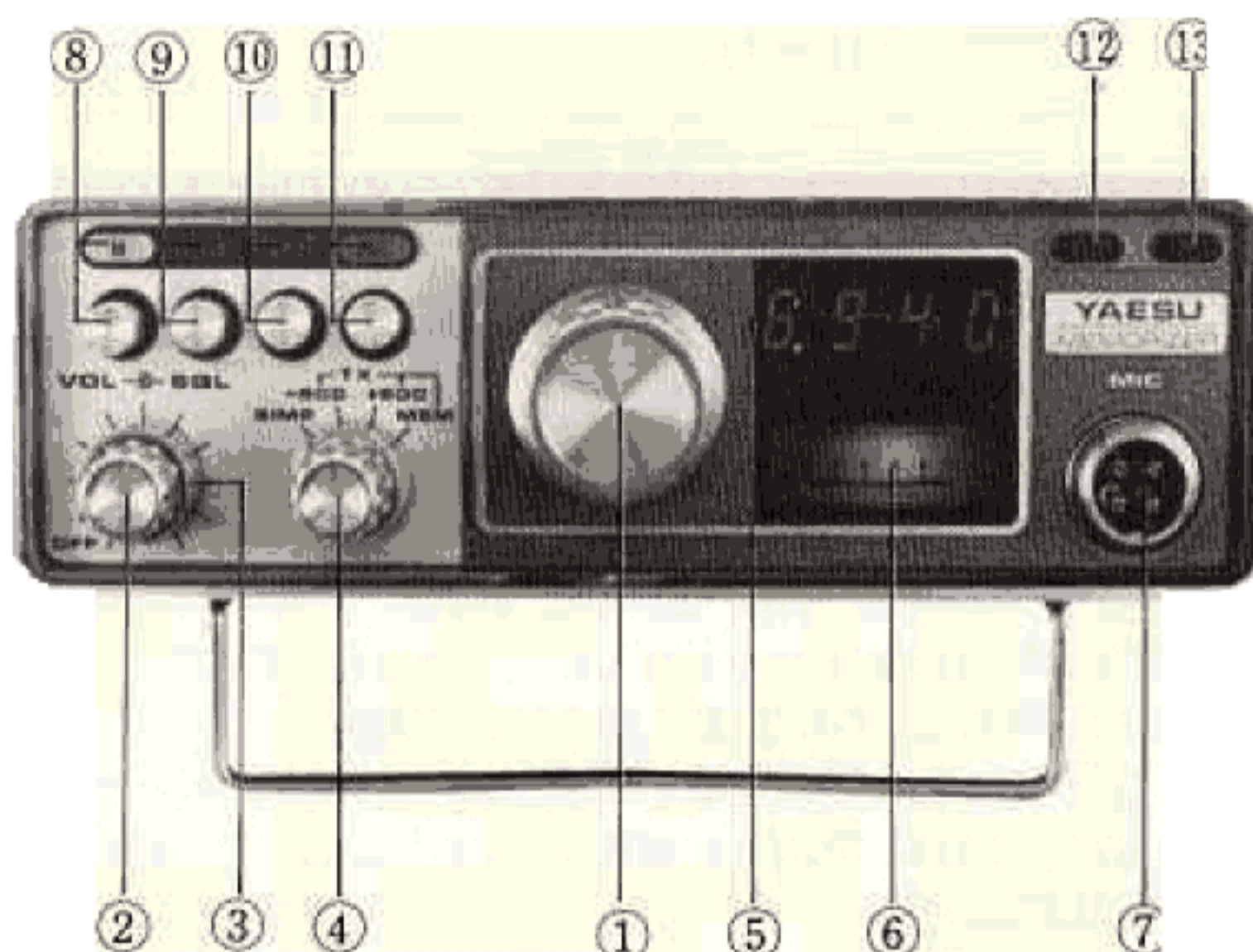

Figure 5

- | | |
|----------------------|---|
| 1. Channel Selector | Endless optical coupling selects 800 channels. |
| 2. VOL inner control | The VOLUME control adjusts the receiver audio output level and turns power off when rotated to an extreme CCW position. |
| 3. SQL Outer control | The SQUELCH control adjusts the receiver squelch threshold sensitivity. |
| 4. FUNCTION Switch | Selects the transmitting frequency
SIMP-Simplex operation. +600-
the transmitting frequency is 600 kHz higher than the receive frequency
-600-the transmit frequency is 600 kHz lower than the receive frequency
MEM-Transmit on memorized frequency. |

- | | |
|--------------------------|--|
| 5. DIAL Display | The digital display indicates the operating frequency. |
| 6. METER | The meter indicates the signal strength on receive and the relative power output on transmit. |
| 7. MIC receptacle | Four pin connector is used for microphone input and push-to-talk relay actuation. |
| 8. MEMORY switch | When pressed, the frequency on the dial is memorized and M lamp lights up. To release the memorized frequency, press the switch a second time. |
| 9. 5UP switch | The channel frequency shifts 5 kHz up and 5UP lamp lights up. |
| 10. TONE SQUELCH switch | An optional TONE SQUELCH circuit is activated when pressed and TONE SQ lamp lights up. |
| 11. MEMORY RECALL switch | When pressed, the memorized frequency is recalled and MR lamp lights up. |
| 12. BUSY indicator | The lamp lights up when a signal is received. |
| 13. ON AIR indicator | The lamp lights up when in the transmit mode. |

REAR PANEL

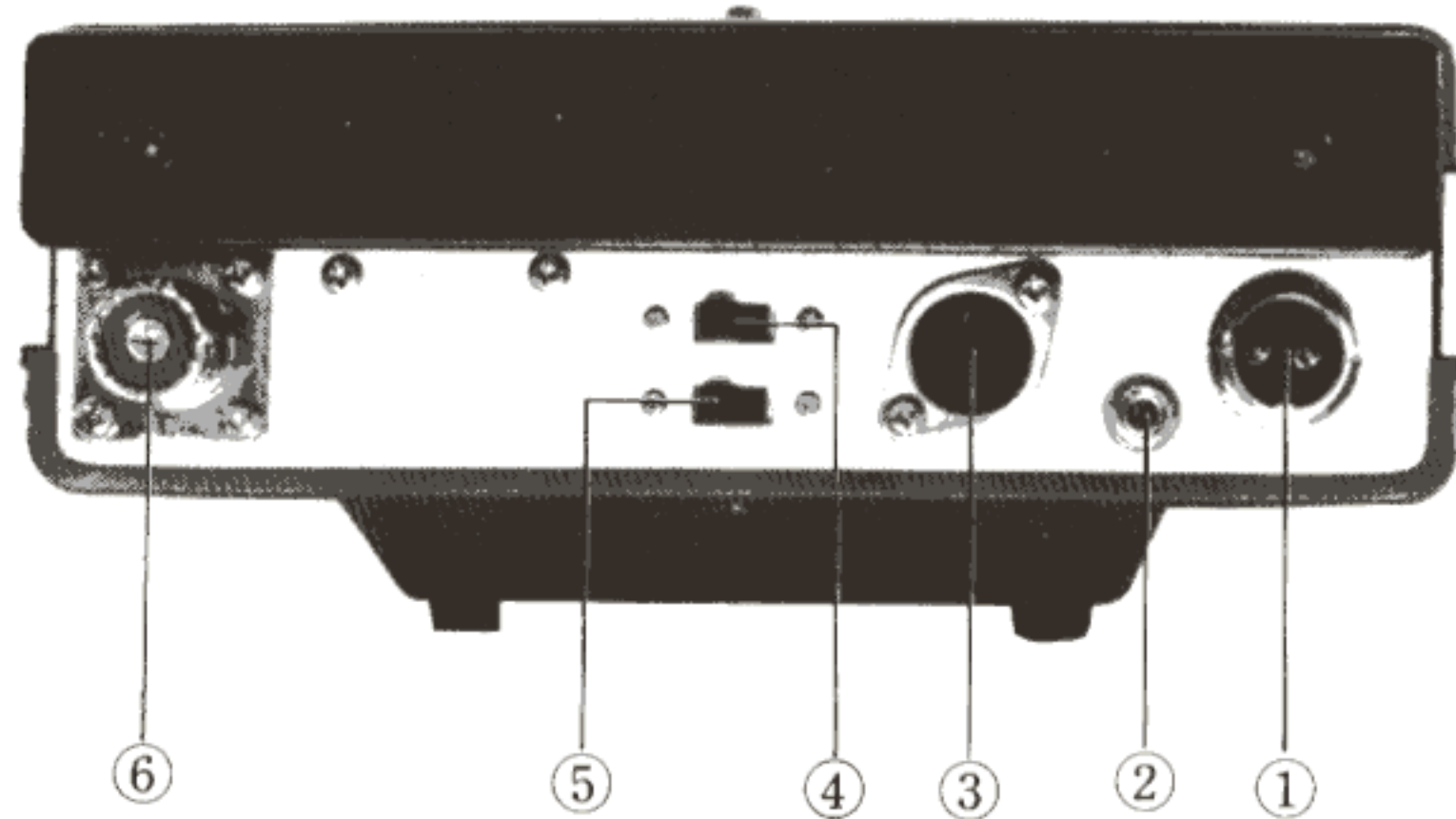

Figure 6

1. POWER receptacle

A two-pin connector is used for connection to 13.8 Volts DC (negative ground) power source, vehicle battery, or AC power supply.

2. SP receptacle

Audio output is provided at this receptacle for an external speaker (Output impedance is 8 ohms and the internal speaker will be disabled when a plug is inserted).

3. ACC socket

The ACCESSORY socket is used for external control of the transceiver.

4. BURST switch

The BURST switch applies a short "tone burst" to the carrier at the start of each transmission in the "ON" position. This is normally used only with "tone access" repeater actuation.

5. HI/LOW switch

The HI/LOW switch selects the desired RF power output, 10 Watts in HI position or 1 Watt in LOW position.

6. ANT receptacle

UHF type coaxial receptacle for connection of antenna.

OPERATION

INITIAL CHECK

1. Rotate the VOLUME control switch in a clockwise direction to apply power. The meter will illuminate and the channel frequency is automatically set to 147.000 MHz (with 5 kHz up at depressed position) regardless of channel knob position. However, a memorized frequency can be retained when the MEMORY switch is left in the depressed position.
2. Rotate the SQUELCH control fully counterclockwise.
3. Adjust the VOLUME control for a normal listening level (background noise or a station if one is transmitting).
4. When the channel is clear, (background noise only), rotate the SQUELCH control clockwise until the receiver is silenced and the busy lamp turns off. Perform this step carefully so as not to go beyond the silencing point or the receiver will not respond to weak signals.
5. Set the HI-LOW switch on the rear panel to the desired power output position.

FREQUENCY SELECTION

The channel select knob selects the frequency at every 10 kHz step. Clockwise rotation increases the frequency up to 148.000 MHz and counterclockwise rotation reduces the frequency down to 143.990 MHz. When the 5 kHz up switch is pressed, the channel frequency is shifted 5 kHz higher. On 144.8005 and 143.990 kHz, the transmitter section is automatically disabled to prevent transmission outside amateur bands.

NOTE: When the memorized frequency is recalled with the channel outside the amateur band (143.990 on 148.005 MHz), the guard circuit is still on, therefore, the transmitter cannot be activated by the PTT switch.

CAUTION

Channel selection should not be done while the transmitter is keyed.

MEMORY OPERATION

Select the channel desired with the channel select knob. Then press the M (Memory) switch. The M lamp lights up indicating the channel is memorized. The memorized frequency shifts 5 kHz up when the 5UP switch is pressed and shifts down when the 5UP switch is released. After the frequency is memorized, the channel selector knob can be used to select other frequencies. To recall the memorized frequency, press the MR (memory recall) switch.

The MR lamp lights up and the memorized frequency is displayed on the dial window. When the MR switch is pressed again, the frequency goes back to the frequency preset by the use of the channel selector knob. The channel selector knob can then be used to select a new frequency. To release the memorized frequency, press the M switch again.

The memorized frequency is kept in the memory when the power is turned off by the front panel switch. However, the memory disappears when the power cord is removed from the power source.

The memory circuit works with the FUNCTION switch in any position.

When the FUNCTION switch is in the MEM position, the MR switch is inoperative and the memorized frequency is transmitted by the PTT switch.

REPEATER OPERATION

The transmitting frequency may be shifted to either the lower or higher side for repeater operation. When the FUNCTION switch is set to \pm 600 kHz, the transmitting frequency shifts 600 kHz up from the displayed receive frequency. With the FUNCTION switch at -600 kHz, the transmitting frequency shifts 600 kHz down.

The MEMORY function can be used with the function switch on the repeater position and the receive frequency is memorized.

For non-standard offset, first memorize the transmit frequency. Then find the receive frequency using the channel selector knob. Set the FUNCTION switch to MEM position. Now the transceiver transmits on the memorized frequency and receives the frequency displayed in the channel window.

Extreme caution should be observed so as not to transmit outside the amateur bands with the FUNCTION switch at \pm 600 kHz and MEM POSITION.

If operating on a repeater channel requiring "tone access," set the BURST switch on the rear panel to the "ON" position. The "tone burst" will be applied to the carrier each time the push-to-talk lever on the microphone is depressed.

NOTE: Refer to the Tone Adjustments paragraph to change the tone frequency or duration (factory set for 1800 Hz and one second).

When ready to transmit, hold the microphone close to your mouth depress the push-to-talk lever and speak distinctly at a normal conversation level. Check that the red "transmit" indicator illuminates and the meter indicates upward.

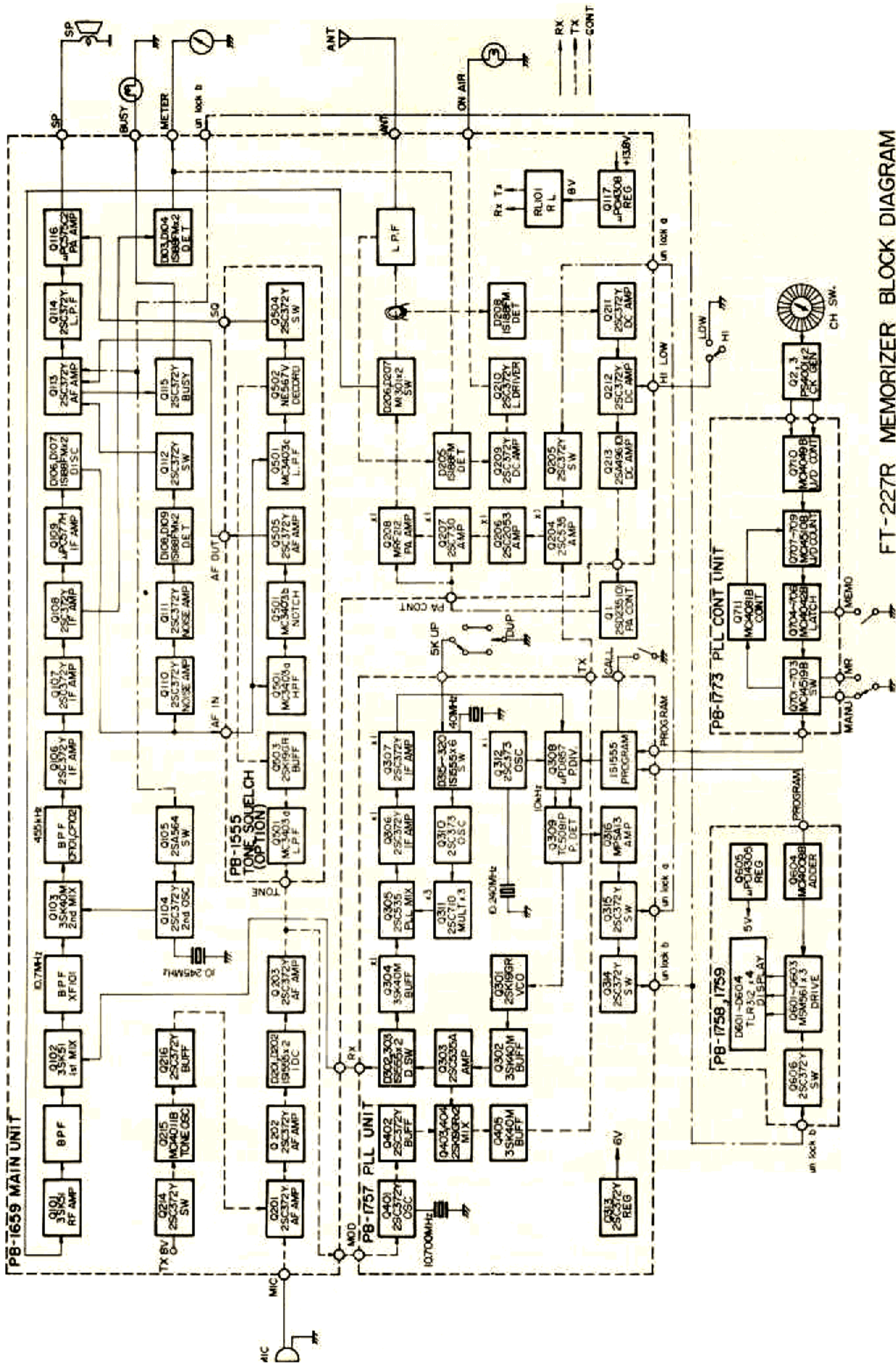

FT-227R MEMORIZER BLOCK DIAGRAM

Figure 7

THEORY OF OPERATION

The block diagram and the circuit description that follows will provide you with a better understanding of this transceiver. Refer to the schematic diagram for circuit details.

The transceiver consists of a transmitter, and a double conversion super heterodyne receiver utilizing a digital phase lock loop synthesizer, capable of operating on any of the 800 channels within the frequency range of 144 to 148 MHz. Solid state circuitry is employed throughout and computer theory is utilized for frequency selection. The transceiver is designed to operate from a 13.8 Volts \pm 10% negative ground power source.

TRANSMITTER

The transmitter produces a Frequency Modulated (FM) signal. The audio signal from the microphone is set to a proper level by VR201 and amplified by Q201, Q202 and Q203, (2SC372Y). The audio output from Q202 is coupled to the IDC (Instantaneous Deviation Control) circuit where both positive and negative peaks are clipped by diodes D201 and D202, (1S1555). The output from the last amplifier Q203 is fed through a low-pass filter which attenuates frequencies above the speech range caused by the clipping at the level set by the deviation control potentiometer VR202. This control is nominally set for a deviation of \pm 5 kHz. The speech signal is then applied to a phase modulator varactor diode, D401, (ISV50) which varies the frequency of the 10.7 MHz crystal controlled oscillator, Q401 (2SC372Y). The frequency modulated 10.7 MHz signal is then amplified by a buffer amplifier Q402, (2SC372Y) and then fed to a balanced mixer consisting of Q403 and Q404, (2SK19GR) where the signal is converted up to 144-148 MHz signal by mixing with the 133.3-137.3 MHz signal delivered from the VCO (voltage controlled oscillator). The output from the balanced mixer is fed through the tuned circuits consisting of T404-T407 to an amplifier Q405, (35K40M). T404-T407 is tuned to the transmitting frequency by varactor diodes D403-D406 of whose capacitance changes in accordance with the DC output Voltage from the PLL circuit. The 144-148 MHz signal is then amplified by the amplifier stages consisting of Q204, (25C535A), Q206, (2SC2053), Q207, (2SC730) and Q208, (MRF212) which delivers 10 Watts of RF energy through a diode switch and low pass filter into a 50 ohm load.

Diodes D205, and D211 (1S188FM) rectify a small portion of the RF output and applies the resultant DC voltage to the meter which indicates relative power output from the transmitter.

The DC output from D205 also is delivered to the lamp driver Q209 and Q210, (2SC372Y) which turns the ON AIR lamp on during the transmission.

If the transmitter is keyed without an antenna being connected, or, if a high VSWR exists in the antenna system, the reflected power is detected through T202 and a diode, D208, (1S188FM) which produces DC voltage. Q211, (2SC372Y) conducts with DC voltage applied through VR205 causing a decrease in Q212, (2SC372Y)'s collector current.

Thus, the collector voltage of Q213, (2SA496) drops, causing Q11, (2SD235) to decrease current and supply voltage to the PA amplifier which is lowered to prevent damage to the transistor. The threshold level is set by VR205. This circuit is also used to switch the output power down to 1 Watt when the HI-LOW switch is set to LOW. The amount of power reduction may be adjusted with VR206.

The antenna change-over circuit consists of switching of diodes D206 and D207, (MI301).

The tone burst circuit consists of a timing generator and a gated multivibrator. With the BURST switch at the "ON" position, a DC voltage is applied to the tone burst circuit. When the transmitter is keyed, Q214, (2SC372Y) conducts and triggers the one-shot multivibrator Q215, (MC14011B). The other half of Q215 generates a tone signal which is amplified by a buffer Q216, (2SC372Y) and applied to the microphone circuit of the transmitter.

The tone frequency is adjustable by VR207, while the output level (deviation) is adjustable by VR209 and the burst duration by VR208.

RECEIVER SECTION

The input signal from the antenna is fed through the low-pass filter consisting of L1, L214, L213, C1 and C243-C245 and the diode change-over switch consisting of D206, D207 and L212 to the FET amplifier Q101, (3SK51). The amplified signal is then applied through four stage high Q coax resonators to the first mixer Q102, (3SK51). The use of a dual gate FET RF amplifier together with high Q coax resonators, minimizes effects of cross modulation and other spurious responses while providing a low noise figure for the receiver front end.

The 144 to 148 MHz signal is heterodyned with the first local oscillator and produces a 10.7 MHz first IF signal. The first local oscillator is delivered from the PLL (Phase Lock Loop) VCO circuit.

The first IF signal is fed through a crystal filter XF101 which has a pass band of ± 7.5 kHz, to the second mixer Q103, (3SK40M) which produces a 455 kHz second IF signal by heterodyning with the 10.245 MHz output signal of the second local oscillator Q104, (2SC372Y). Q105, (2SA564) works as a switch which disconnects the supply voltage to Q104 when the PLL circuit is unlocked.

The second IF circuit consists of Q106, Q107, Q108, (2SC372Y) and Q109, (μ PC577H). The cascade connected ceramic filters CF101 and CF102 provide narrow band selectivity for the receiver and the limiting action of Q109 removes any amplitude variation to the ceramic discriminator consisting of CD101, D106, and D107, (1S188FM).

The discriminator produces an audio output in response to a corresponding frequency shift in the IF signal. The output audio signal is amplified by Q113, Q114, (2SC372Y) and is applied across the VOLUME control VR1 to the input of the audio amplifier Q116, (μ PC575C2). The output from Q116 is applied in series through the ACC socket to the internal speaker. The low-pass filter between Q113 and Q114 attenuates the audio frequency spectrum above 3 kHz to increase readability of the received signal.

A portion of the 455 kHz IF signal is rectified by D103, D104, (1S188FM) for S-meter indication. VR101 is used to adjust the meter sensitivity.

When no carrier is present in 455 kHz IF, the high frequency noise at the discriminator output is amplified by Q110 and Q111, (2SC372Y) then detected by D108 and D109, (1S188FM) to produce a DC voltage. This voltage is then applied to turn Q112, (2SC372Y) on. With the conduction of Q112, the base of Q113 is grounded to squelch the audio amplifier. When a carrier is present in the 455 kHz IF, the noise is removed from the discriminator output and the audio amplifier then recovers normal operation.

The squelch circuit opening causes Q113 to conduct, causing lamp driver Q115, (2SC372Y) to draw current to light up the BUSY LAMP. The SQUELCH controls, VR2 and VR102, set the threshold level.

HETERODYNE OSCILLATOR

The heterodyne signal is generated by the PLL (phase lock loop) circuit consisting of VCO (voltage controlled oscillator), reference crystal oscillator, programmable divider and phase comparator.

The VCO oscillator, Q301 (2SK19GR) generates 133.3-137.3 MHz signals. The oscillator frequency is controlled by a varactor diode D301, (1S2209) which varies the capacitance of a tuned circuit consisting of L301, TC301, C302 and C304 in accordance with a DC voltage supplied from a phase comparator Q309, (TC5081P).

The output signal from Q301 is amplified by a buffer amplifier Q302, (3SK40M) and Q303, (2SC535A) and fed through a diode switch, D302 and D303, (1S1555) to the receiver or transmitter mixers.

A portion of the output from Q303 is fed through a buffer amplifier Q304, 3SK40M to a PLL mixer, Q305, (2SC535A) which produces 1-5 MHz PLL IF signaled by mixing with the PLL heterodyne signal.

The PLL heterodyne signal is generated by a overtone crystal controlled oscillator Q310, (2SC373). The crystal frequency is shown in Table 1.

X-Tal	Frequency	PLL Het. Freq.	Remarks
X301	44.10000 MHz	132.300	Simplex
X302	43.90000	131.700	TX-600 kHz shift
X303	44.30000	132.900	TX+600 kHz shift
X304	44.10166	132.305	Simplex 5 kHz up
X305	43.90166	131.705	TX-600 kHz 5kHz up
X306	44.30166	132.905	TX+600 kHz 5kHz up

Table 1

The diode switch D315-D320, 1S1555 selects the appropriate crystal in accordance with the FUNCTION switch and 5kHz up switch. The output from Q310 is fed to a tripler Q311, (2SC710) which produces the PLL heterodyne signal.

The PLL IF signal is fed through a low pass filter consisting of L305, C331 and C332 to the amplifiers Q306 and Q307, (2SC372Y). The amplified signal is then fed to a programmable divider, Q308, (uPD857C).

The crystal oscillator, Q312, (2SC373) generates 10.24 MHz signal, and its output is fed to the scaler/divider Q308 (uPD857C), where the 10.24 MHz signal generates a 10 kHz reference signal.

The digital phase comparator Q309, TC5081P compares the phase of the PLL IF signal with that of the reference signal, and any phase difference is converted into an error correcting voltage. This error correcting voltage is fed to the varactor diode D301 which changes the output signal phase to lock with that of the reference signal.

When the VCO is locked, the constant voltage at pin 4 of Q309 is applied to Q316, (MPSA13) to conduct, and in turn Q315, (2SC372Y) cuts off. The "H" voltage at the collector of Q315 turns Q205, (2SC372Y) to conduct and it supplies DC voltage to the exciter younger stages Q204 and Q206. When the VCO is unlocked, the DC voltage at the emitter of Q205 drops to prevent a normal operation of Q204 and Q206.

The output voltage from Q315 is reversed in polarity by Q314, (2SC372Y) and applied to the Q606, (2SC372Y) keeping the collector of Q606 in "H" level in order to drive Q601 through Q603 for the display of the channel frequency. The voltage is also applied to Q105, (2SA564) which supplies DC voltage to a second heterodyne oscillator Q104, (2SC372Y).

When the VCO is unlocked, the collector DC voltage drops causing the LED's to turn off and simultaneously the second heterodyne oscillator ceases to oscillate. Thus the receiver is muted until VCO lock occurs.

PLL CONTROL SECTION

The optical coupling system utilizes two photo-interrupters Q2 and Q3, (PS-4001) to generate two signal outputs which are applied to a PLL counter unit. The signal applied to CK terminal is fed through a waveshaper Q710, (MC14049B) to BCD up down counter, Q707 (10 kHz), Q708 (100 kHz) and Q709 (1 MHz), using MC14510B as a clock signal.

The signal applied to U/D terminal is inverted by a unit of Q710 and controls the up-down counter. The output from Q707-Q709 is fed to a 4 bit data selector, Q701-Q703 (MC1451B) and Quad latch, Q704-Q706, (MC14042B), which are used for memory when the MEMORY switch is pressed.

The output from Q701-Q703 is fed to a programmable divider Q308, (μ PD857C).

Q711, (MC14081B) (for high end) and Q712, (MC14028B) (for low end) cut off Q713, (2SC735Y) to prevent any transmission outside the amateur bands.

The BCD signals at the input of the programmable divider are also fed to the LED driver, Q601-Q603, (MSM561) to drive LED, D601-D603, TLR 312.

4-BIT full adder, Q604, (MC14008B) is used as a binary adder to produce 4-8 display on MHz range.

LED, D604, TLR312) displays 0 or 5 by the 5 UP switch.

The display LED will be turned off by Q605, (2SC372Y) when an unlocked signal is received.

POWER SUPPLY

DC 13.8 Volt supply is used for the audio power amplifier Q116, relay and lamps. The supply voltage to the driver and final power amplifier is

fed through the voltage regulator, Q11 (2SD235D) which is controlled by the HI/LOW switch and the automatic final protection circuit.

Voltage regulator, Q605 (μ PC14305) regulates the supply voltage at 5 Volts to supply Q308 and the display unit, Q313, (2SC372Y) and D301, (RD68EB) regulates the supply voltage at 6 Volts for the VCO and phase comparator. The 5 Volts supply for the PLL control unit is regulated by a zener diode, D3, (WZ050) and is connected directly to keep memory when the power switch is turned off with M switch pressed.

A regulated 8 Volt supply using Q117, (μ PC14308) is used for all other circuits.

When the function switch is at MEM position, D4 (WZ050) supplies 5 Volts to the receiver, and D5, (WZ050) supplies 5 Volts to the transmitter.

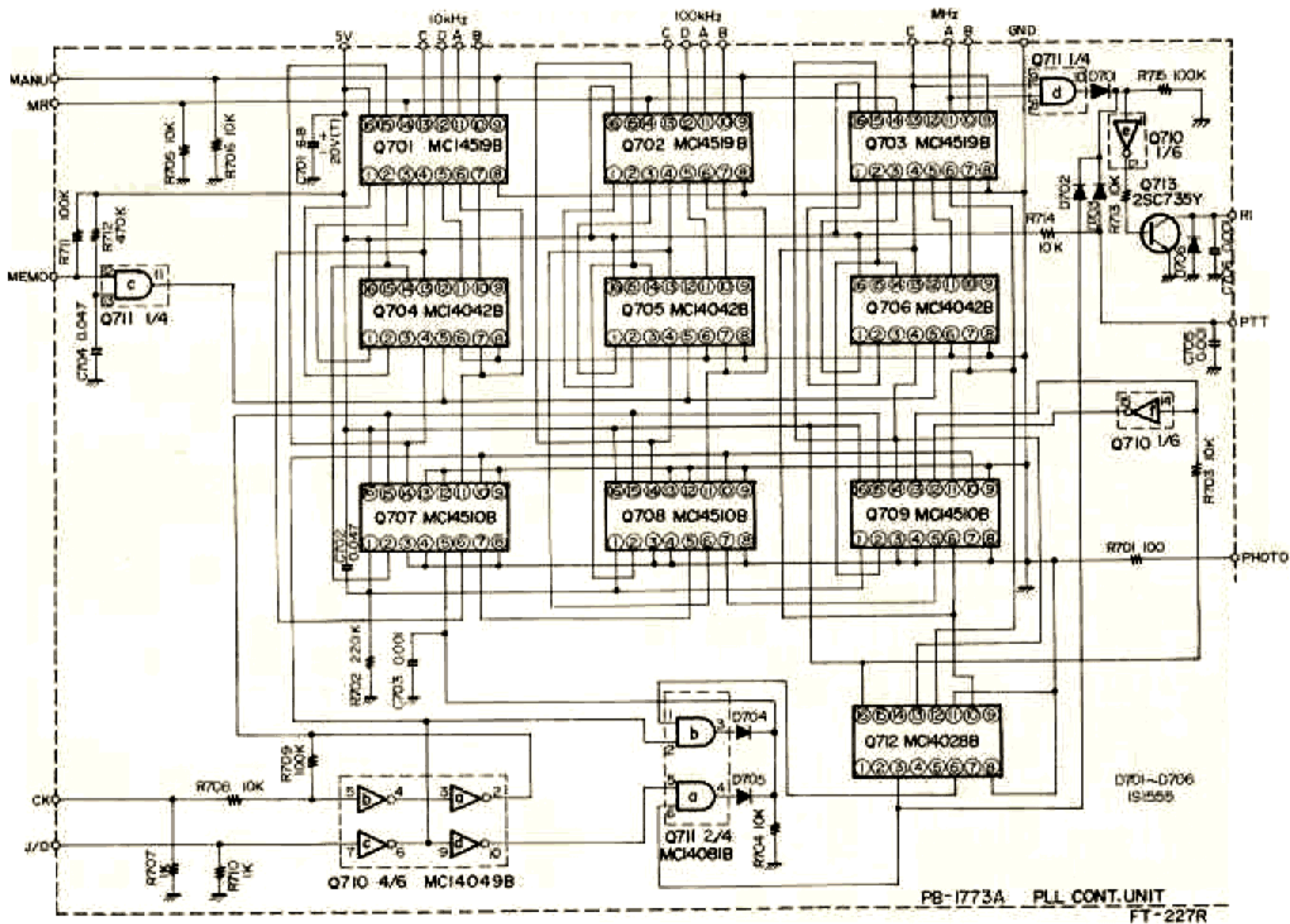

Figure 8

OPTIONAL TONE SQUELCH CIRCUIT

The Tone Squelch operation permits private communications on crowded channels. The tone squelch circuit disables the audio circuit of receiver until a preset tone signal is received.

The transmitted signal is modulated by the tone signal within 70 Hz to 250 Hz which is below the 300 Hz to 3000 Hz voice frequency range used in radio communications.

The tone signal is generated by Q502, NE567 and its frequency is set by R516, VR502 and C516. The level of the tone signal is set by VR504 and it is fed through a buffer amplifier Q503, 2SK19GR to the low-pass filter consisting of unit "d" of an operational amplifier Q501, MC3403. The tone signal is then superimposed to the speech signal by Q202. The constants for preset frequency are obtained from the chart.

The audio output signal from the receiver discriminator is fed to the unit "a" of Q501, MC3403. The unit "a" of Q501 forms a high-pass filter and the unit "b" of Q501 forms a T-notch filter. Both filters remove the tone signal from the audio signal which is then fed through an audio amplifier Q505, 2SC372Y to the receiver audio amplifier Q111.

The tone signal passes through a low pass filter by unit "c" of Q501 and is fed to Q502, NE567. When the tone signal has the same frequency as preset for transmitting, the voltage of pin 8 of Q502 becomes low causing Q504, 2SC372Y to "OFF". In turn, proper bias voltage is applied to Q119 for normal operation.

Without proper tone signal, Q504 conducts, removing the proper bias from Q119 to disable the audio circuit.

As the conventional carrier squelch circuit is operative when the tone squelch is switched in, the busy lamp lights up when any carrier is received.

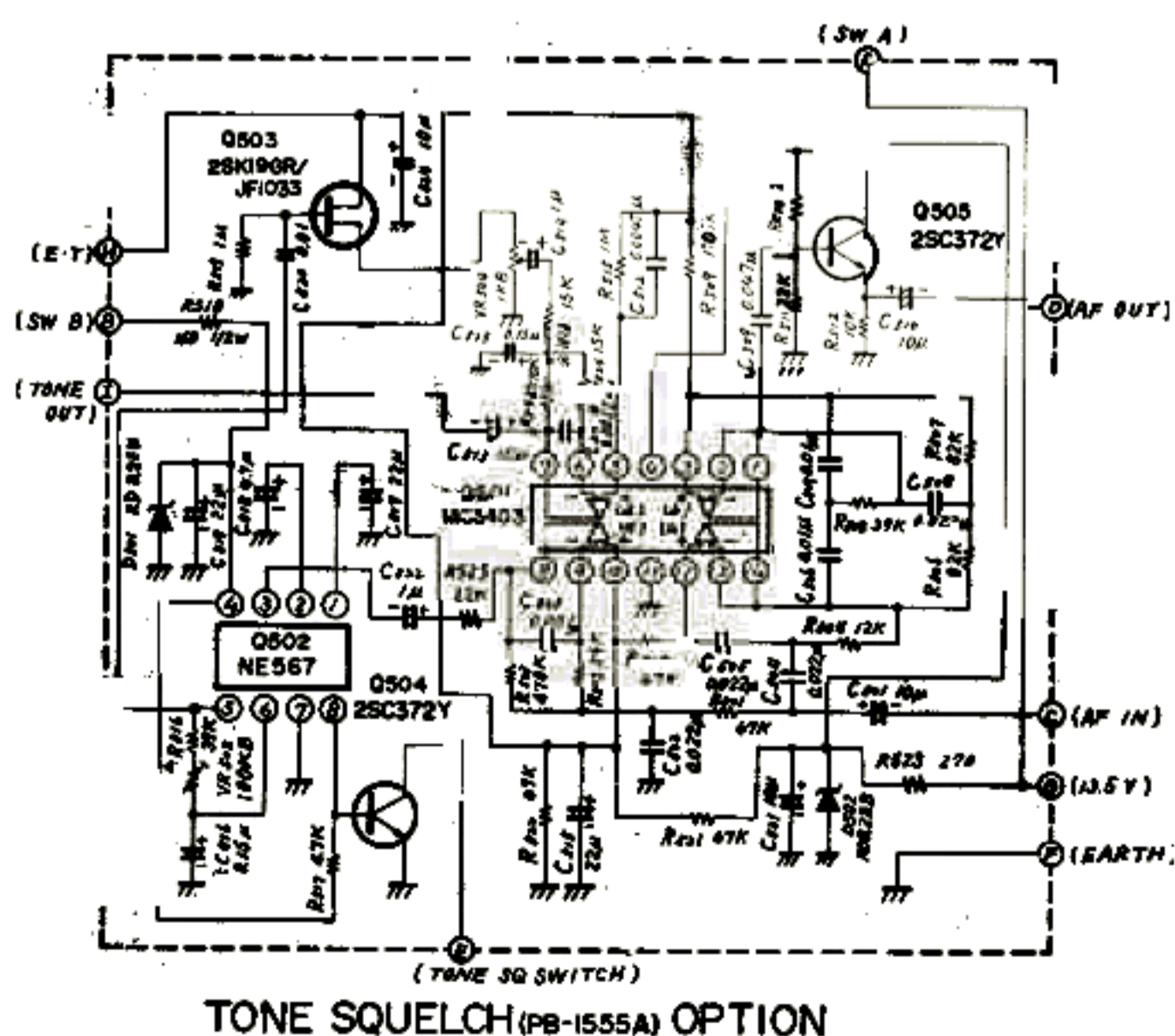

Figure 9

	C 516 *	R 516 *	R 513 *	R 514 *	R 524 *
70Hz / 160Hz	0.15μF	39KΩ	15KΩ	470KΩ	15KΩ
160Hz / 250Hz	0.1μF	33KΩ	8.2KΩ	270KΩ	8.2KΩ

Table 2

MAINTENANCE & ALIGNMENT

GENERAL

The model FT-227R transceiver has been carefully aligned and tested at the factory prior to shipment. The reliability of the solid-state devices used in the FT-227R should provide years of trouble free service if the transceiver is not abused and normal, routine maintenance is carried out.

THE FOLLOWING PRECAUTIONS SHOULD BE OBSERVED TO PREVENT DAMAGE TO THE TRANSCEIVER:

- (1) Do not exceed 14 Volts DC, at the POWER receptacle. When operating mobile, check the battery voltage under the load (transmitter "keyed" in FM mode) with the engine running fast enough so the ammeter shows a "change!" In addition, do not operate the FT-227R if the supply voltage is below 12 Volts DC.
- (2) Avoid direct exposure to sunshine or water.

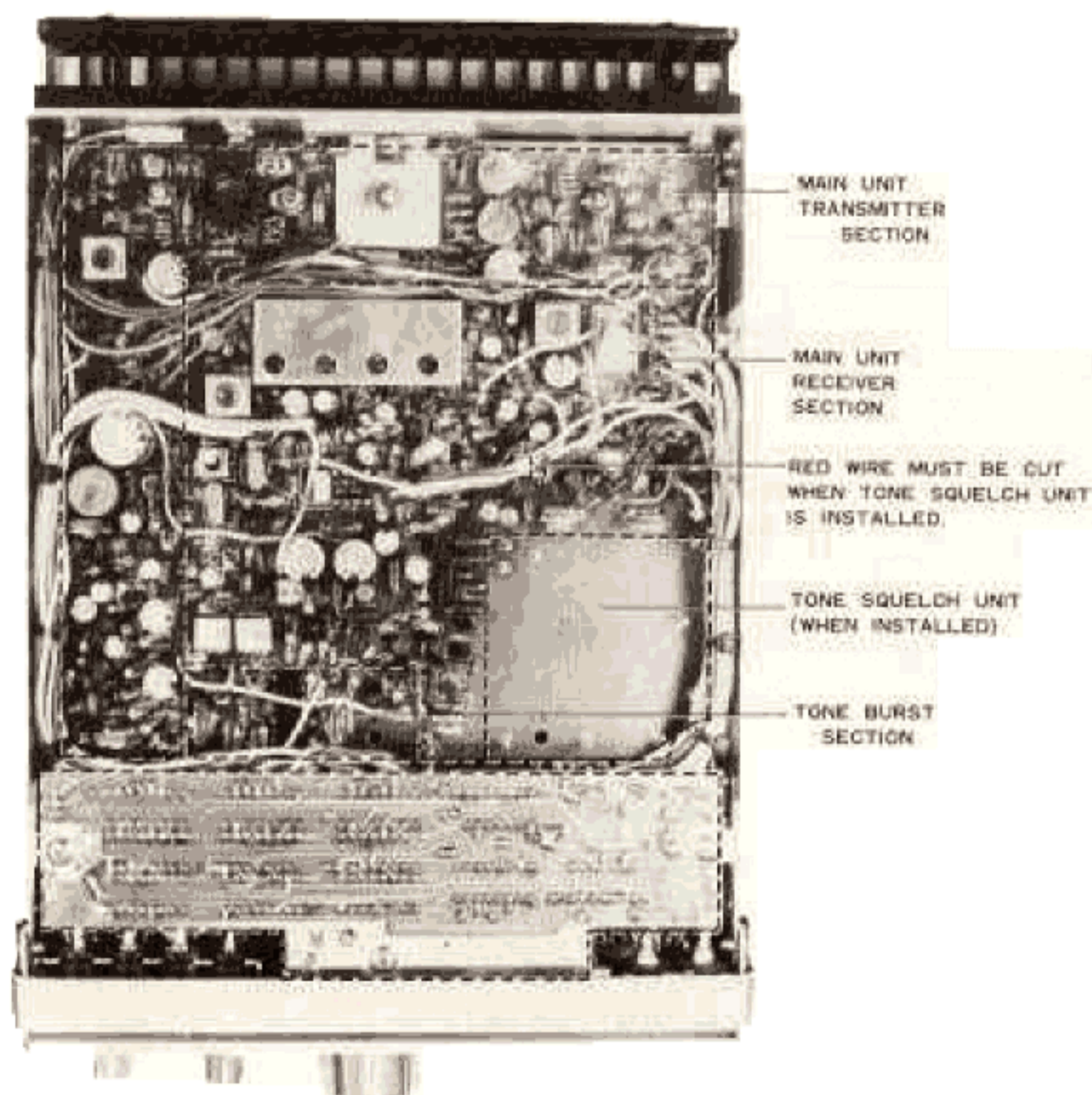

Figure 10 TOP VIEW

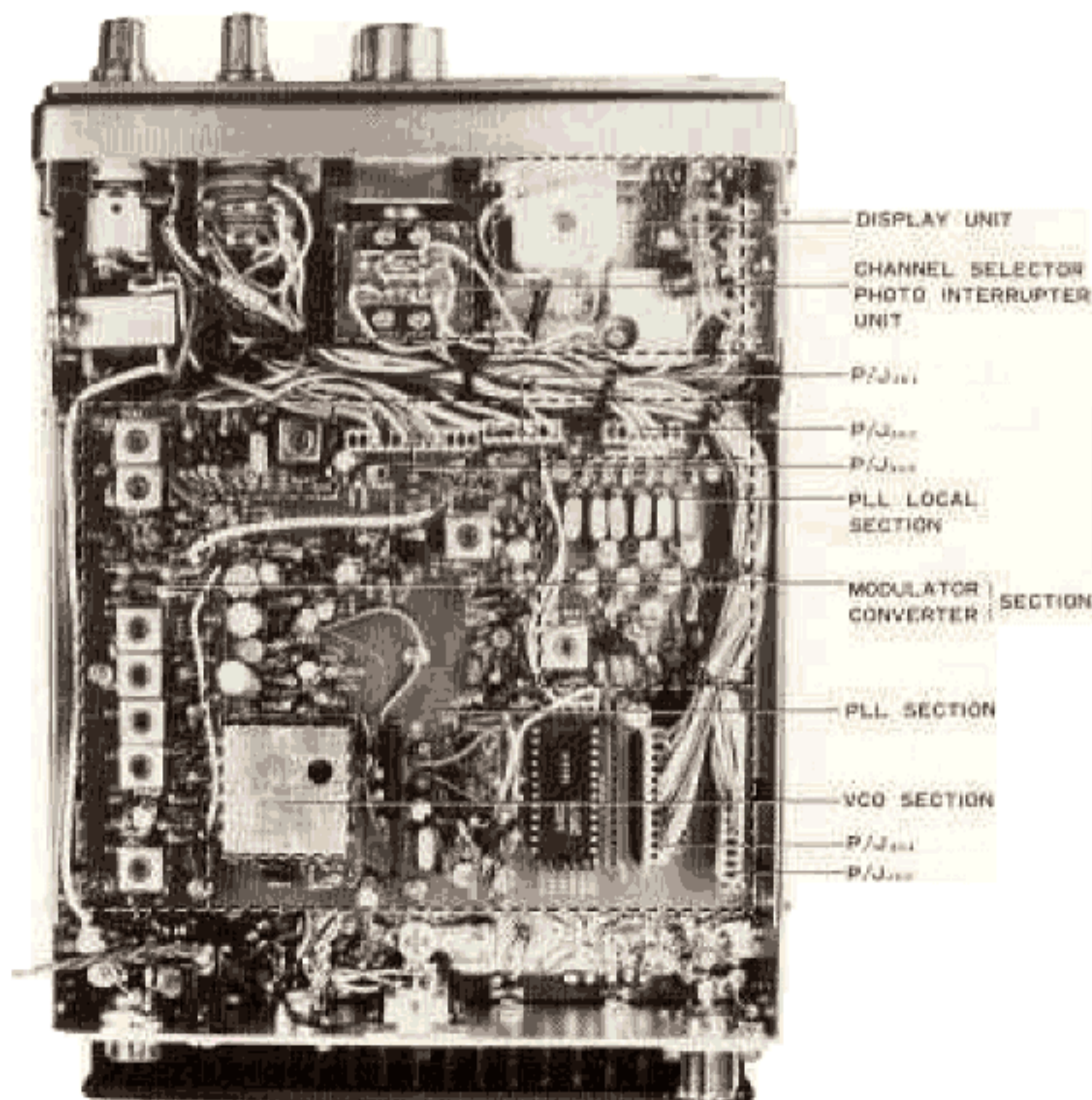

Figure 11 BOTTOM VIEW

ROUTINE MAINTENANCE

Routine maintenance should be limited to keeping the transceiver clean, and periodic performance checks of the transmitter RF power output and the receiver sensitivity.

Cleaning:

When the transceiver has been used in dusty or sandy areas, the interior should be periodically cleaned. A vacuum-cleaner should be used, while any caked or accumulated dirt may be removed with a soft brush. Check the interior to make sure that it is thoroughly dry before replacing the case and/or operating equipment. Wipe the exterior with a damp cloth whenever required.

PERFORMANCE CHECKS

Make all performance checks at 13.5 Volts DC (under load).

Check the transmitter output as follows:

- (a) Connect a suitable 50 ohm dummy load/RF wattmeter to the ANT receptacle.
- (b) Set the channel selector to any channel and key the transmitter while observing the power output. The power should be approximately 10 Watts, and the S-meter should read between 6 and 8 relative power output.

Check the receiver sensitivity as follows:

Connect an AC VTVM to the SP receptacle, and set the SQUELCH control fully counter-clockwise.

Connect the RF output of a precision, VHF signal generator to the ANT receptacle and with no signal input note the VTVM reading. Adjust the VOLUME control and VTVM range, as required, to obtain an approximate full scale reading. (DO NOT change the VOLUME control setting after this adjustment is made).

Set the signal generator to the receiving frequency of the transceiver and adjust the output amplitude of the signal generator until the VTVM reads 1/10th (20 dB decrease) of the reading in step (b). The signal generator output voltage at this point is the 20 dB quieting sensitivity, and should be approximately 0.3 μ V.

If the above performance checks indicate a need for realignment it is recommended that the transceiver be returned to the dealer for alignment. The alignment procedures require special test equipment and techniques not normally available to the average owner. Attempts to realign the tuned circuits without proper test equipment may result in degraded performance of the transceiver.

ALIGNMENT

SOME OF THE FOLLOWING ALIGNMENT PROCEDURES REQUIRE SPECIAL TEST EQUIPMENT AND TECHNIQUES AND SHOULD ONLY BE DONE BY AN EXPERT TECHNICIAN.

TRANSMITTER

(1) RF Power Amplifier

- a) Set the channel to 147.0 MHz. Connect a YP-150 50 ohm dummy load/watt meter to the antenna connector. Connect a VTVM between TP1 and ground (1V DC range).
- b) Key the transmitter and peak T201 for maximum VTVM reading.
- c) Set the HI/LOW switch to HIGH position and VR205 to extreme CCW position. Peak TC201 through TC206 for maximum power output as indicated on the YP-150.
- d) Set the HI/LOW switch to LOW position and set VR206 for 1 Watt output.

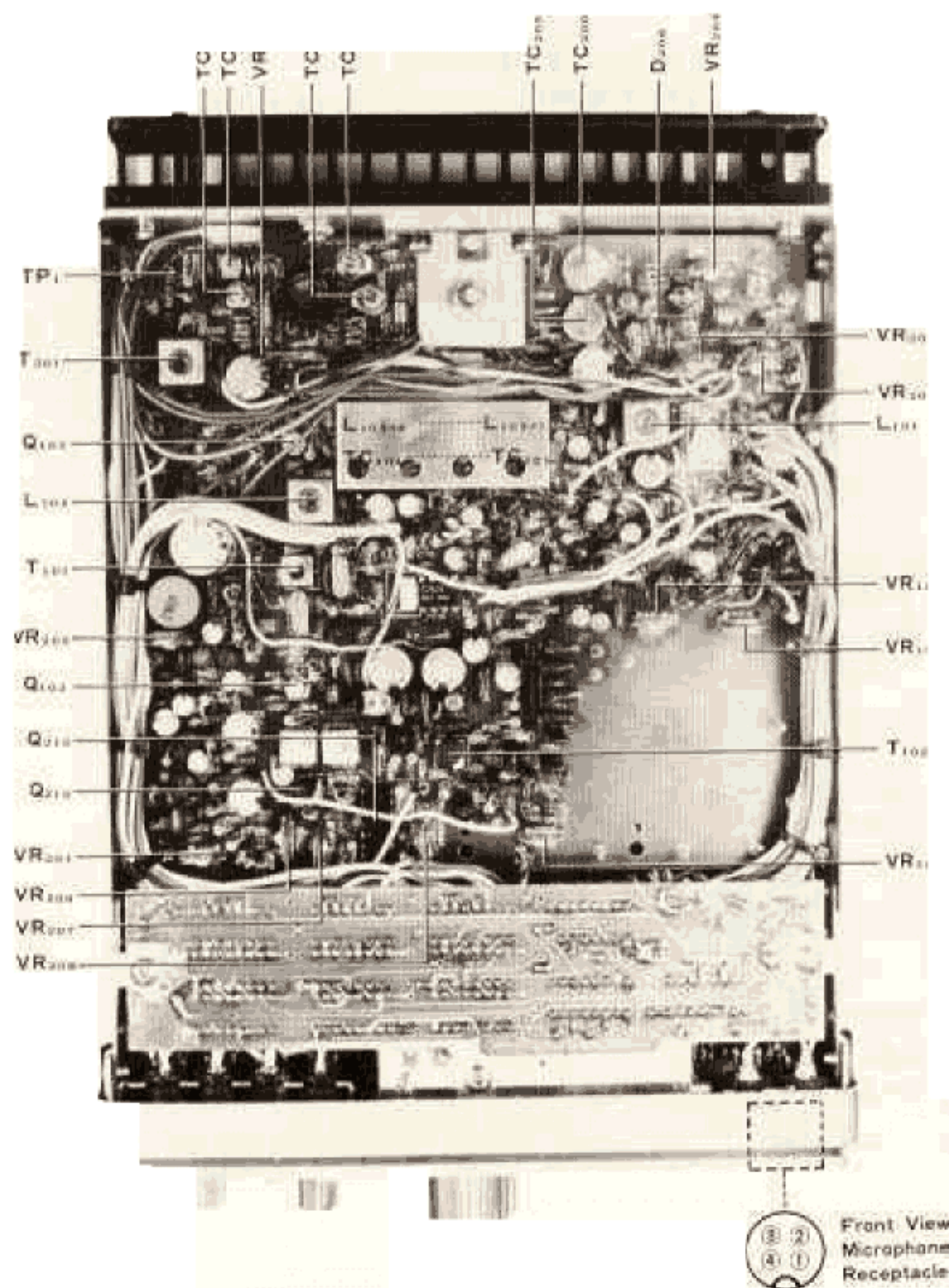

Figure 12

ALIGNMENT POINT

(2) AFP (Automatic Final Protection)

- a) Connect the YP-150 to the antenna connector. Set VR205 to the extreme CCW position. Connect the VTVM to cathode (+) of D208 and ground (-) and adjust VR204 for minimum VTVM reading.
- b) Slowly advance VR205 in CW (Clockwise) direction until the output power is about to decrease.

(3) PO Meter

Set VR203 to the point where S meter shows 8 with full output.

(4) Deviation

- a) Connect YP-150 to the antenna connector, the output of an audio oscillator between pin 2 (hot) and 1 (ground) of microphone receptacle and a deviation meter as illustrated in Fig. 13. Set the audio output level to 25 mV at 1 kHz.
- b) Connect a frequency counter between TP3 of the PLL unit and ground.
- c) Key the transmitter by grounding pin 3 of microphone receptacle. Adjust T401 for a 10.7 MHz counter reading.
- d) Set the output level of the audio signal generator to 25 mV at 1 KHz and adjust VR202 for ± 5 kHz deviation.
- e) Set the audio level to 2.5 mV. Adjust VR201 for a deviation of ± 2.5 kHz.

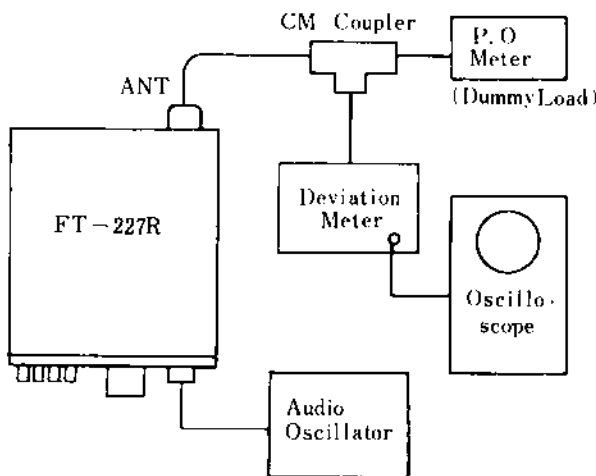

Figure 13

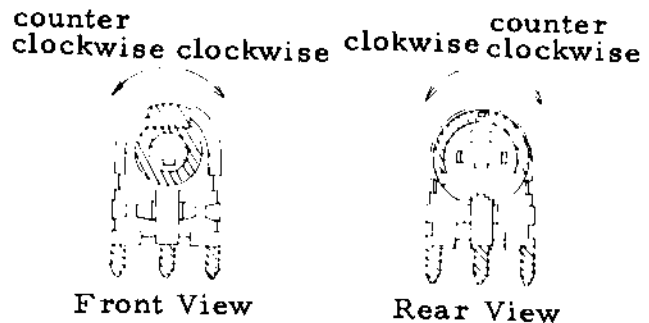

Figure 14

(5) Tone Burst

- a) Connect a YP-150 dummy load to the antenna connector and disconnect the microphone to prevent accidental voice modulation.
- b) Temporarily connect pin 5 of Q215 to pin 14.
- c) Connect a YC-500 frequency counter to the emitter of Q216, and set TONE BURST switch to the ON position.
- d) Key the transmitter and adjust VR207 to the desired burst frequency.
- e) Connect VTVM to MIC IN terminal and adjust VR209 for 2.5 mV VTVM reading.
- f) Remove the temporarily connected wire in step (b). Key the transmitter and adjust VR208 for desired burst duration.

RECEIVER

(1) RF Amplifier

- a) Connect the calibrated signal generator to the antenna connector and set the channel selector to 147.0 MHz.
- b) Tune the signal generator to the receive frequency and peak L101 through L104 and TC101 through TC104 for maximum S meter reading.

(2) First IF Amplifier

- a) Connect a sweep generator to the second gate of Q102. Connect an oscilloscope through a detector to the drain of Q103.
- b) Set the frequency of the sweep generator to 10.7 MHz and apply its output. Adjust T101 until the scope pattern illustrated in Fig. 15 is available.
- c) Disconnect the sweep generator and scope. Measure the RF injection voltage to the second gate of Q103. A nominal value is 0.8-1.0 Volt rms.

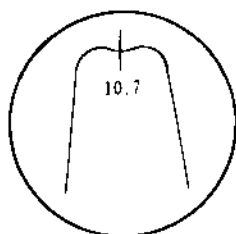

Figure 15

RETTELSSES - BLAD

(3) S Meter Sensitivity

- a) Apply the signal generator output to the antenna connector. Peak T102 for maximum S meter reading.
- b) Set the output level of the signal generator to 20dB and adjust VR101 for full scale indication on the S meter.

4) Noise Squelch Threshold

- a) Receive 0 dB signal from the signal generator.
- b) Set the SQL control on the front panel to TONE position and slightly advance clockwise direction to minimum SQL position. Set VR102 to the point where the squelch starts to open.

PLL Circuit

- a) Set the channel frequency to 146.00 MHz
- b) Connect the YC500S frequency counter to TP3 of the PLL unit and adjust TC309 for 5.1200 MHz, and make sure the RF voltage of the emitter of Q312 is approximately 1.6 Volts rms.
- c) Connect RF probe of the VTVM to the base of Q311 and peak TC308 for maximum VTVM reading. Slowly rotate TC308 in the direction of increasing capacitance until the VTVM reading becomes 5% lower than peak indication (approx. 60 mV rms).
- d) Connect RF probe of the VTVM to the base of Q305. Key the transmitter and peak T302 for maximum VTVM reading (approx. 170 mV rms).
- e) Connect the YC-500S frequency counter between cathode of D302 in PLL unit and the ground. Set the FUNCTION switch to SIMP. Adjust TC302 for 135.300 MHz counter reading.
- f) Set the FUNCTION switch to -600. Key the transmitter and adjust TC303 for 134.700 MHz counter reading. Adjust TC304 for 135.900 MHz at +600.
- g) Set the FUNCTION switch to SIMP. Press 5UP switch down. Adjust TC305 for 135.305 MHz in receive mode. Key the transmitter at -600 and adjust TC306 for 134.705 MHz, at +600 kHz adjust TC307 for 135.905 MHz.
- h) Connect VTVM (DC10V range) between the cathode of D324 and ground. Adjust TC301 for 3.4 Volt VTVM reading.
- i) Connect RF probe of VTVM between TX out terminal and ground in PLL unit. Peak T402 -T408 for maximum VTVM reading in transmit.

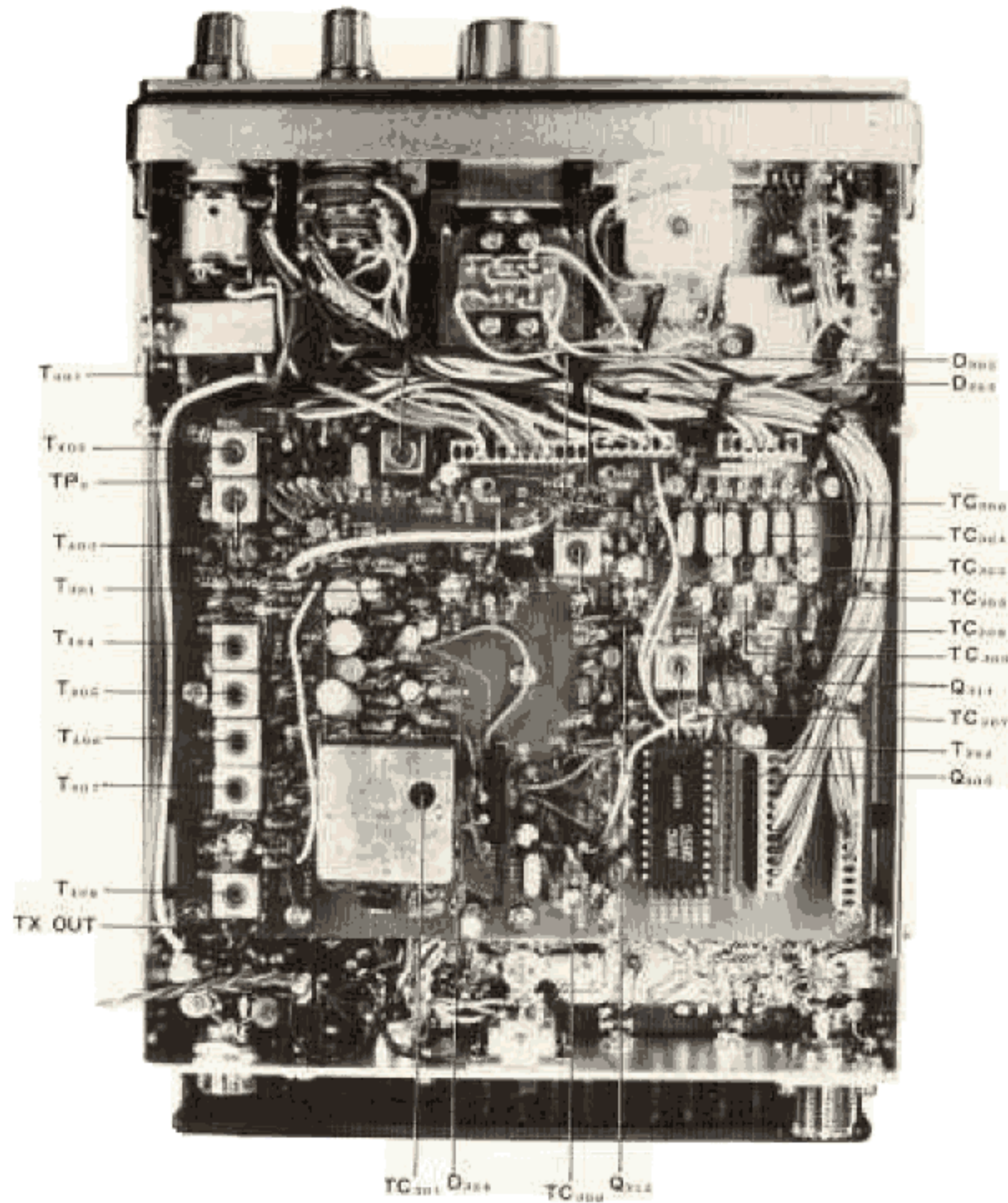

Figure 16 ALIGNMENT POINT

Optional tone squelch

The optional tone squelch unit has been set to 77 Hz operation at the factory, however, the tone squelch frequency can be chosen to any frequency between 70 Hz to 160 Hz by the setting of VR502. The transmitting level of the tone signal is set by VR504.

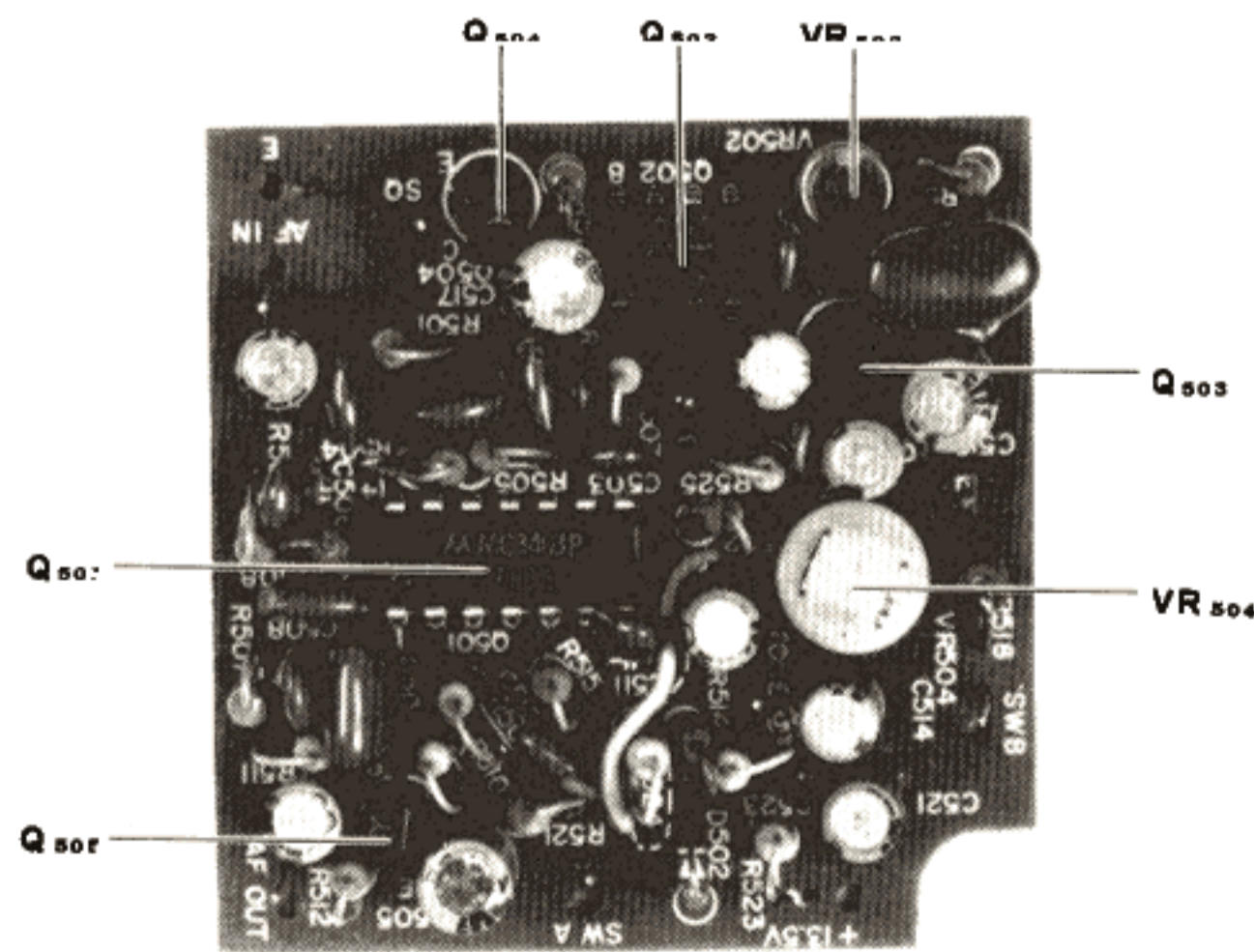
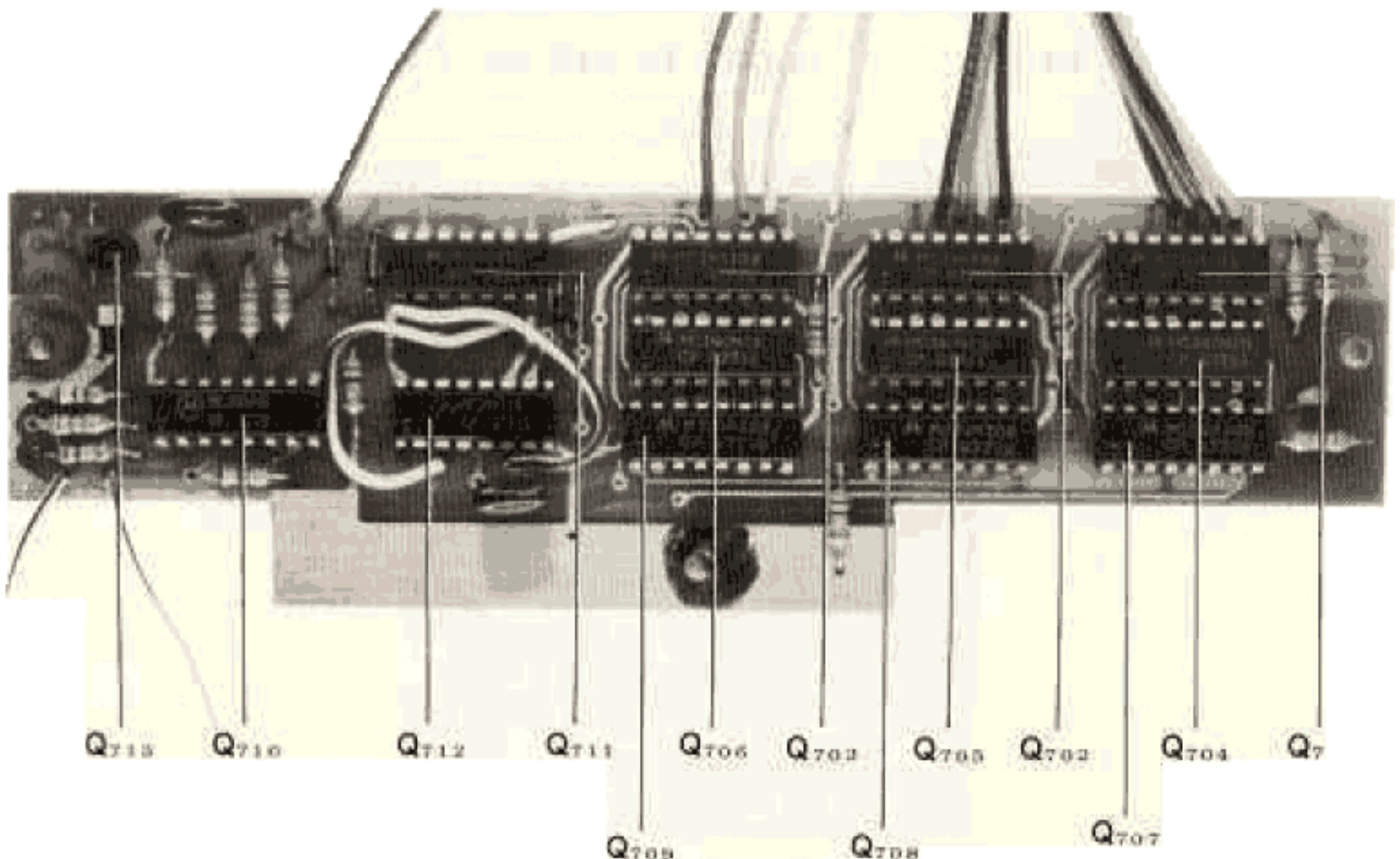
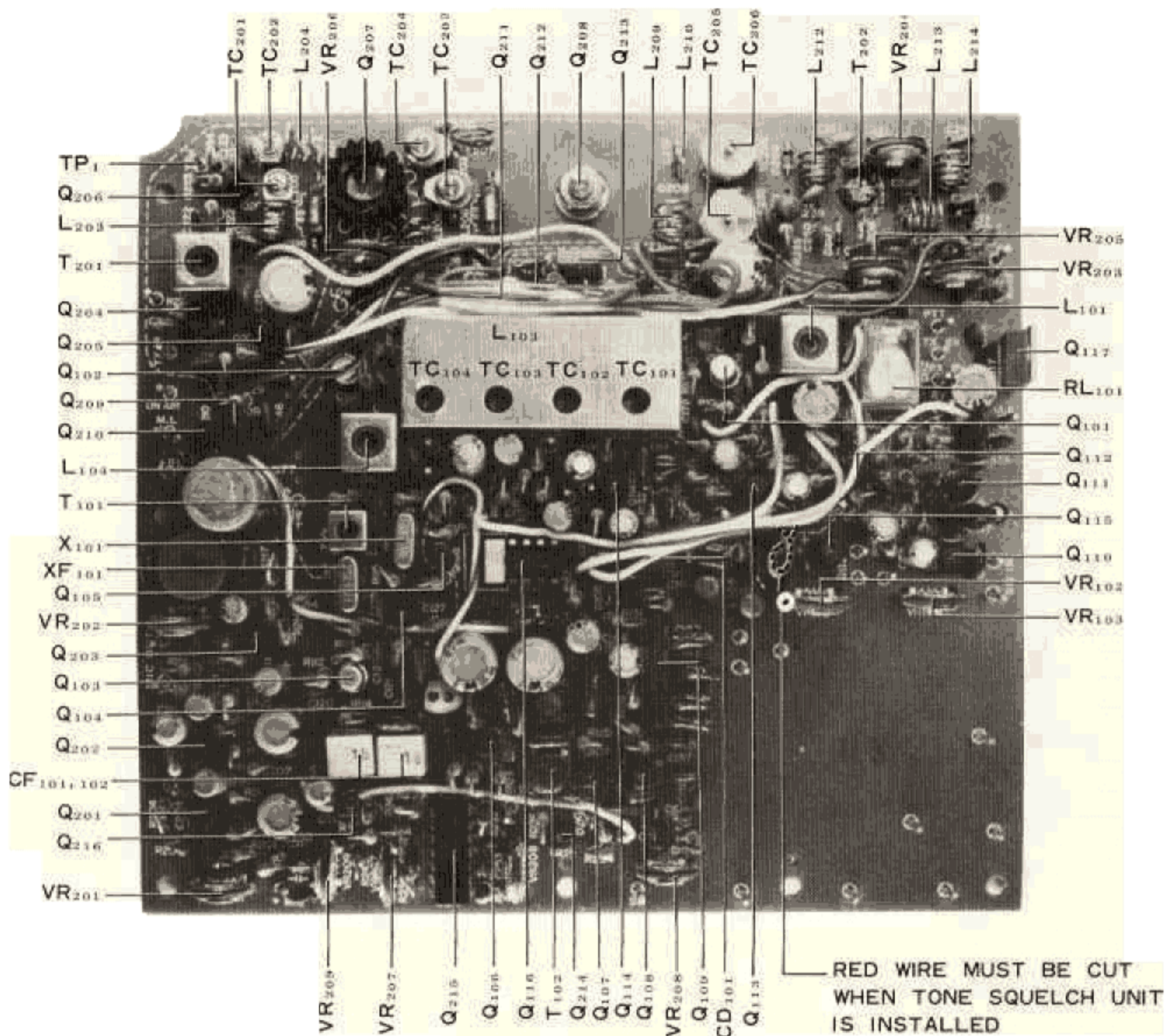
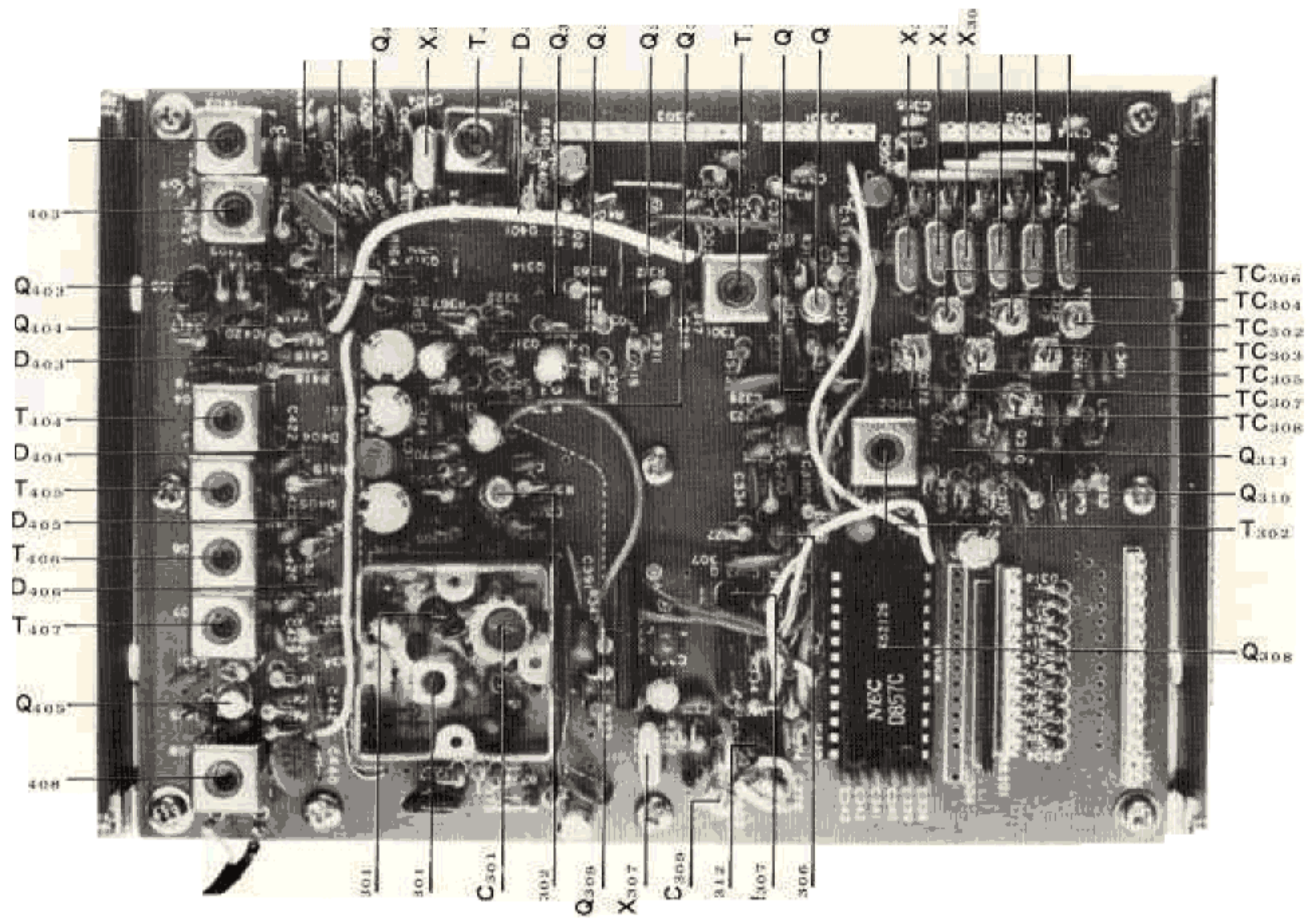

Figure 17



PLL CONTROL UNIT



PLL

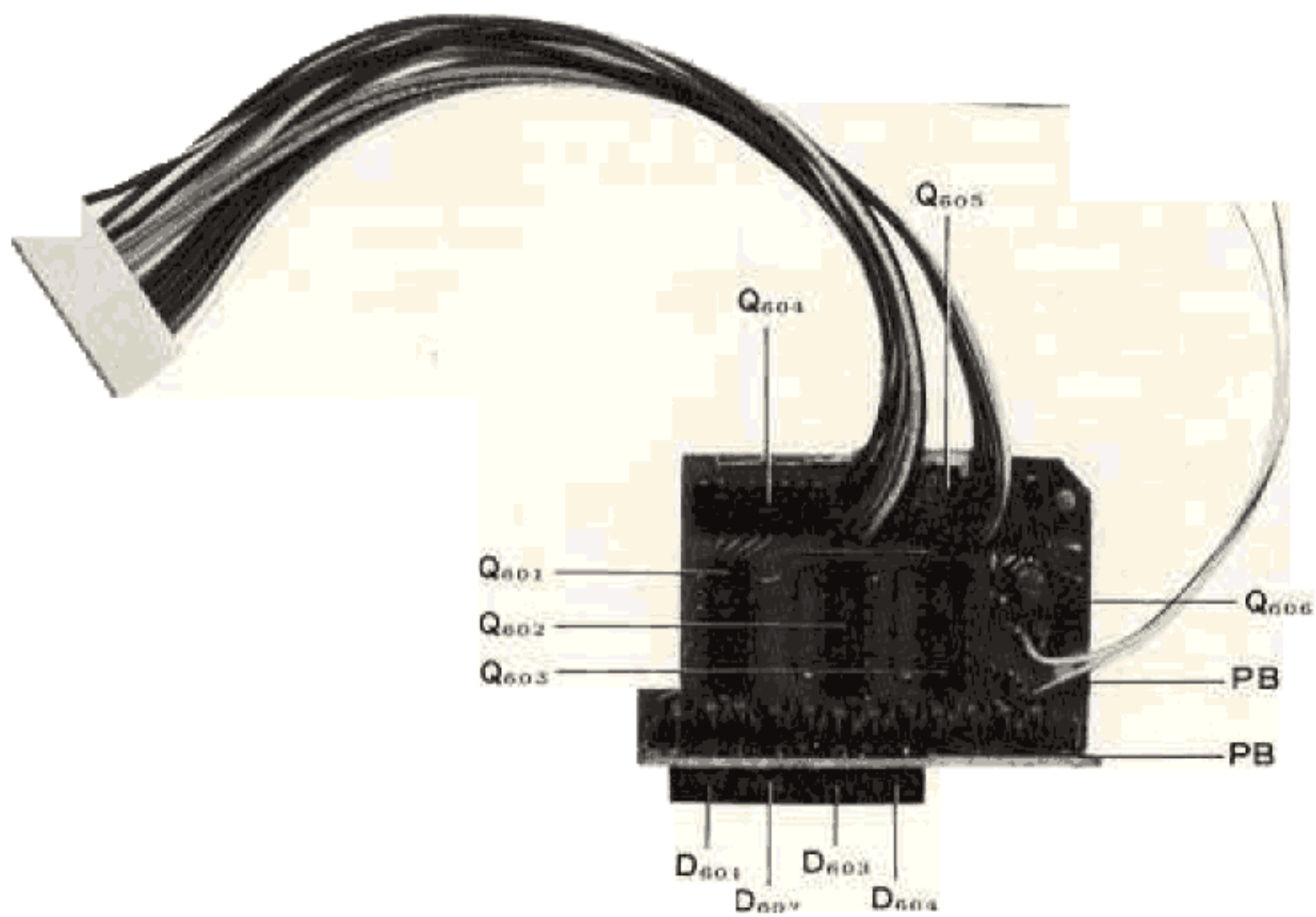

DISPLAY UNIT

PARTS LIST

MAIN CHASSIS					
Symbol Number	Parts Number	Description			
				94000041	FT-16P (Volume)
				94000042	FT-16PA (Tx Selector)
				94000040	FT-16PD (Squelch)
Q1	22402353	Silicon Transistor 2SD235			
		DIODE			
D1	2 090130	Silicon Diode U05B			
D2	21015550	Silicon Diode 1S1555			
D3,D4,D5	21090111	Zener Diode WZ050			
		RESISTOR			
R4	40143100	Carbon Film 1/4W VJ 10Ω	Q109	25000118	IC μPCS77H
R3	40143821	" " " " 820Ω	Q116	25000119	" μPC575C2
R6,7	42144821	" Composition " GK 820Ω	Q117	25000116	" μPC14308
R5	42144103	" " " " 10KΩ	Q215	25000114	" MC14011B
R8	42124220	" " " " 22Ω	Q103	23800401	FET 3SK40M
R1	42124471	" " " " 470Ω	Q101,102	23800510	" 3SK51
			Q213	22104963	Transistor 2SA496O
		POTENTIOMETER	Q105	22105640	" 2SA564
VR1(with S1)	49800079	DM11A 5M1111 10KH/10KA	Q104,106-108,110	22303724	" 2SC372Y
			Q111 115,201-203		
			Q205,209-212,214		
			Q216		
		CAPACITOR			
C1	31829150	Ceramic 50WV SL 15PF	Q204	22305351	" 2SC535A
C2	30820102	Ceramic 50WV 0.001μF	Q207	22307300	" 2SC730
C8,C9,C10	30820103	Ceramic 50WV 0.01μF	Q206	22320530	" 2SC2053
C3,C6,C7	34220106	Electrolytic 16WV R 10μF	Q208	22390005	" MRF212
C5	34220226	Electrolytic 16WV R 22μF			
C4	34120107	Electrolytic 10WV R 100μF			
					DIODE
			D103,104,106-109	21001880	Germanium Diode 1S188FM
			D205,208,209,211	"	
		INDUCTOR			
L1	55003160	Lowpass Coil #220196	D101,102,105,110	21015550	Silicon Diode 1S1555
			D111-113,201-204		
			D210,212		
CH	50000010	AF Choke Coil #230012	D206,207	21090128	" " MI301
					CRYSTAL
		METER	X101	71500046	HC-18/U 10.245MHz
M1(with PL6)	74000310	AP-120 200μA			
					MONOLITHIC FILTER
			XF101	71200015	FMT-15A
		SPEAKER			
SP1	76000013	SM-77K-Y 8Ω 1W			CERAMIC FILTER
			CF101,102	71200016	LFB-15
		SWITCH			CERAMIC DISCRIMINATOR
S6,S7	63000002	SSF-22-06	CD101	70900001	SFD455S4
S8	62000026	BS2-4-4			
					RESISTOR
			R224	40143479	Carbon Film 1/4W-VJ 4.7Ω
		CONNECTOR	R248	41143220	" " " TJ 22Ω
J1	68020006	FM-142S	R102,105,107,112	40143560	" " " VJ 56Ω
J2	68020012	SG-8050	R110,124,131,157	40143101	" " " VJ 100Ω
J3	68050003	CS-250	R201,208,220		
J4	68000007	JSO-239	R252	41143101	" " " TJ 100Ω
J5	68040003	FM-144S	R123	40143151	" " " VJ 150Ω
			R147,162,215	40143221	" " " VJ 220Ω
		PILOT LAMP	R126,128,129,163	40143471	" " " VJ 470Ω
PL1-PL5,PL7	14000025	BQ054-32732A	R223,228,232		
			R209	40143561	" " " VJ 560Ω
TB1	90030003	Terminal Board 1L6P(S)	R117	40143681	" " " VJ 680Ω
			R206,216,219	40143102	" " " VJ 1KΩ
		KNOB	R114,142,151	40143152	" " " VJ 1.5KΩ
			R202	40143182	" " " VJ 1.8KΩ
	94000037	FT-30T (Channel Selector)			

PARTS LIST

PLL UNIT			R301	40143474	Carbon Film 1/4W-VJ 470KΩ
Symbol Number	Parts Number	Description			
PB-1757A	60317571	Printed Circuit Board			BLOCK RESISTER
PB-1765	60317650	• •			
		IC, FET & Transistor	RB301	47000005	11×100KΩ
Q309	25000087	IC TC5081P			POTENTIOMETER
Q308	25000086	• μPD857C			
Q301, 403, 404	22800195	FET 2SK19GR			
	23800401	MOS FET 3SK40M			
	22303724	Transistor 2SC372Y			CAPACITOR
			C423, 426	31829059	Ceramic 50WV SL 0.5PF
			C326	31829010	• • SL 1PF
			C303	31820010	• 50WV CH 1PF
			C420, 422, 424	31820020	• • CH 2PF
			C333	31829030	• • SL 3PF
			C306	31820030	• • CH 3PF
		IC SOCKET	C357~362	31820040	• • CH 4PF
QS401	68240001	116-24-30-114	C404	31827040	• • UJ 4PF
			C304	31825040	• • N330 4PF
		DIODE	C310, 435	31829050	• • SL 5PF
D302~320, 322~324	21015550	Silicon Diode 1S1555	C317	31820050	• • CH 5PF
D402	29090004	• MV-103	C421, 425, 428	31827060	• • UJ 6PF
D321	21090131	Zener Diode RD6.8EB	C302, 305	31820070	• • CH 7PF
D301, 403-406	21022090	Varactor Diode 1S2209	C373	31820080	• • CH 8PF
D401	21090108	• 1SV50	C417, 418	31827080	• • UJ 8PF
			C323, 327, 332, 369	31829100	• • SL 10PF
		CRYSTAL	C301, 307	31820120	• • CH 12PF
X301, 401	71800073	HC-18/U 44.100MHz	C368	31820150	• • CH 15PF
X302	71800080	• 43.9MHz	C331	31829180	• • SL 18PF
X303	71800081	• 44.3MHz	C413, 414	31820200	• • CH 20PF
X304	71800082	• 44.10166MHz	C429	31829270	• • SL 27PF
X305	71800083	• 43.90166MHz	C365, 378, 438	31820330	• • CH 33PF
X306	71800084	• 44.30166MHz	C370	31820390	• • CH 39PF
X307	71800075	• 10.240MHz	C374, 407, 438	31829470	• • SL 47PF
X401	71800062	• 10.700MHz	C314	31829101	• • SL 100PF
			C405, 406	31820101	• • CH 100PF
		RESISTOR	C403	31827101	• • UJ 100PF
R364, 425, 428	40143560	Carbon Film 1/4W-VJ 56Ω	C308, 313, 319~	30820102	• • 0.001μF
R302, 303, 307, 312	40143101	• • • VJ 100Ω	C322, 324, 338~348		
R319, 354, 358, 359			C354~356, 363, 364		
R360, 371, 408, 418			C372, 380, 390, 392,		
R311, 412~415	40143221	• • • VJ 220Ω	C395, 402, 432, 434, 437		
R373	40143681	• • • VJ 680Ω	C441		
R355	40143821	• • • VJ 820Ω	C311, 312, 315, 316	30820103	• • 0.01μF
R324, 327, 361, 365	40143102	• • • VJ 1KΩ	C318, 325, 329, 330		
R367, 369, 407, 411			C333, 335, 366		
R334	40143122	• • • VJ 1.2KΩ	C367, 371, 375, 384		
R323, 356, 372, 375	40143152	• • • VJ 1.5KΩ	C394, 408~411, 415		
R313, 328, 349, 350	40143222	• • • VJ 2.2KΩ	C416, 419, 430, 431, 442		
R314, 315, 343~348	40143332	• • • VJ 3.3KΩ	C334	30820223	• • 0.022μF
R404	40143562	• • • VJ 5.6KΩ	C321, 350~352, 391, 398, 430, 440	30820473	• • 0.047μF
R309, 321, 325, 335~	40143103	• • • VJ 10KΩ	C386, 397	36825473	Mylar Film • 0.047μF
R337, 352, 357, 363			C376	36824101	Styrol • 100PF
R409, 426, 427			C377	36824221	• • 220PF
R368, 374	40143153	• • • VJ 15KΩ	C385	36526104	Tantalum 35WV 0.1μF
R317, 353, 362, 366	40143223	• • • VJ 22KΩ	C387	36526475	• • 4.7μF
R401, 406, 410			C353	36526106	• • 10μF
R326	40143273	• • • VJ 27KΩ	C349	34120476	Electrolytic 10WV-R 47μF
R310, 318, 402, 424	40143333	• • • VJ 33KΩ	C379, 381, 389	34120107	• • R 100μF
R322, 423	40143393	• • • VJ 39KΩ	C309, 382, 396	34220106	• 16WV-R 10μF
R376, 405	40143473	• • • VJ 47KΩ	C383, 386, 398, 401	34820105	• 50WV-R 1μF
R304~306, 316, 342	40143104	• • • VJ 100KΩ			
R370, 377, 416, 417					
R419~422, 429					

PARTS LIST

		TRIMMER CAPACITOR				CAPACITOR	
TC301	39000069	TZOIY 070A	7PF	C703,705,706	30820102	Ceramic	50WV 0.001 μ F
TC302~309	39000011	ECV-1ZW 20X53	20PF	C702,704	36825473	Mylar Film	0.047 μ F
				C701	36226685	Tantalum	20WV 6.8 μ F
INDUCTOR							
L301	55003189	VCO Coil	# 220359				
L309	55003150		# 220205				
L303,304,307	55003120		# 220206				
L302	53020005	Micro Inductor	3.3 μ H	DISPLAY UNIT			
L306,308	53020018	" "	10 μ H	Symbol Number	Parts Number	Description	
L305	53020025	" "	33 μ H			PRINTED CIRCUIT BOARD	
L313	53020026	" "	47 μ H	PB-1758	60417580	Display Board	
L312	53020021	" "	220 μ H	PB-1759	60417590	Driver Board	
L311,401	53020001	" "	1mH				
L310	53020003	" "	4mH				
IC & TRANSISTOR							
				Q605	25000109	IC	μ PC14305
				Q601~603	25000085	"	MSM561
				Q604	25000088	"	MC14008B
T301,302,404~406	54141020	R12-4102	# 220111	Q606	22303724	Transistor	2SC372Y
T401	55003213		# 221024				
T402,403	54140730	R12-4073	# 220149				
DIODE							
				D601~604	21090122	LED	TLR312D
MINI CONNECTOR							
J301,302	67060005	5048-06A					
J303,304	67110004	5048-11A					
J305	67140001	5048-14A					
RESISTOR							
P301	68060008	5047-06 with Wire	# 240046	R623	40143181	Carbon Film	$\frac{1}{4}$ W-VJ 180 Ω
P302	68060009	" "	# 240047	R625	40143331	" "	$\frac{1}{6}$ W-VJ 330 Ω
P303	68110006	5047-11	# 240048	R601~622	40143471	" "	VJ 470 Ω
P304	68110007	" "	# 240049	R624	40143681	" "	VJ 680 Ω
P305	68140007	5047-14	# 240050	R626	40143103	" "	$\frac{1}{4}$ W-VJ 10K Ω
CAPACITOR							
	80041041	VCO Case		C601	30820102	Ceramic	50WV 0.001 μ F
	80041051	VCO Case Cover		C602	36526474	Tantalum	35WV 0.47 μ F
	91100008	Wrapping Terminal C		C603	34120107	Electrolytic	10WV-R 100 μ F
					80039531	Heat Sink A	
					67200003	Board Joint	163740
					91100008	Wrapping Terminal C	
CONTROL UNIT							
Symbol Number	Parts Number	Description		Symbol Number	Parts Number	Description	
PB-1773A	60517730	Printed Circuit Board		SWITCH BOARD			
		IC, TRANSISTOR				SWITCH BOARD	
Q701~703	25000089	MOS IC	MC14519B	PB-1763A	60317631	Printed Circuit Board	
Q704~706	25000090	MOS IC	MC14042B				
Q707~709	25000091	MOS IC	MC14510B				
Q710	25000092	MOS IC	MC14049B	S2~S5	65000022	PUSH SWITCH ZU-EE-20	
Q711	25000093	MOS IC	MC14081B				
Q712	25000136	MOS IC	MC14028B				
Q713	22307354	Transistor	2SC735Y				
PHOTO INTERRUPTER BOARD							
		DIODE		Symbol Number	Parts Number	Description	
D701~706	21015550	Silicon Diode 1S1555					
				PB-1690A	60316901	Printed Circuit Board	
		RESISTOR				PHOTO INTERRUPTER	
R701	41143101	Carbon Film	$\frac{1}{4}$ W-TJ 100 Ω	Q2, Q3	29090010	PS4001	
R707,710	41143102	" "	TJ 1K Ω				
R703~706,708,713,714	41143103	" "	TJ 10K Ω				
R709,711,715	41143104	" "	TJ 100K Ω				
R702	41143221	" "	TJ 220K Ω				
R712	41143474	" "	TJ 470K Ω				

PARTS LIST

ACCESSORIES			TONE SQUELCH UNIT		
Symbol Number	Parts Number	Description	Symbol Number	Parts Number	Description
		ACCESSORIES			Tone Squelch Board with Components
	77000011	Microphone Assembly YE-11	PB-1555A	60315551	Printed Circuit Board
		with Microphone Hanger, Screws			
	67040001	Microphone Plug FM-144P			IC, FET & TRANSISTOR
			Q501		IC MC3403
	67050003	ACC Plug CP-0084	Q502		NE567
			Q503	22800195	FET 2SK19GR
	96000020	Power Cord Assembly #240028	Q504, 505	22303724	Tr 2SC372Y
	67020006	Power Plug FM-142P			
	69000002	Fuse Holder SN-1102			DIODE
	73000003	Fuse 3A	D601	21090131	Zener Diode RD8.2EB
	67020008	Sigarette Lighter Adapter			RESISTOR
			R518	40143101	Carbon Film $\frac{1}{4}$ W VJ 100 Ω
			R512	40143103	" " " " 10K Ω
			R504	40143123	" " " " 12K Ω
	73000003	Fuse 3A	R510, 511, 517	40143223	" " " " 22K Ω
			R502, 508	40143393	" " " " 39K Ω
	67020003	External Speaker Plug P-2240	R501, 505, 521, 522	40143473	" " " " 47K Ω
			R506, 507	40143823	" " " " 82K Ω
	93100046	Tap Connector No. 560	R509, 514	40143154	" " " " 150K Ω
			R503	40143474	" " " " 470K Ω
	80038631	Stand	R515, 519	40143105	" " " " 1M Ω
			R513, 524	40143153	" " " " 15K Ω
	80038661	Mobile Bracket Assembly with Set Screws	R516	40143393	" " " " 39K Ω
			R513, 524*	40143822	" " " " 8.2K Ω
			R514*	40143274	" " " " 270K Ω
			R516*	40143333	" " " " 33K Ω
					POTENTIOMETER
			VR501, 504	49905102	SR-19R 1K Ω B
			VR502	49800084	TM062P 100K Ω B
					CAPACITOR
			C503	36825102	Mylar 50VV 0.001 μ F
			C512	36825472	" " " 0.0047 μ F
			C506, 507, 520	36825103	" " " 0.01 μ F
			C502, 504, 505, 508, 511	36825223	" " " 0.022 μ F
			C509	36825473	" " " 0.047 μ F
			C516	36825154	" " " 0.15 μ F
			C516*	36825104	" " " 0.1 μ F
			C514, 522	34820105	Electrolytic 50VV 1 μ F
			C501, 510, 513, 521, 524	34226106	" " " 16VV 10 μ F
			C515, 517, 519	34226226	" " " 22 μ F
			C523	36226154	Tantalum 35VV 0.15 μ F
			C518	36226475	" " " 4.7 μ F

YAESU MODEL FT-227RA

The FT-227RA is an adaptation of the FT-227R which provides expanded memory capability as well as scanning capability. The scanner will search for a busy or clear channel, as desired, or will scan indefinitely until halted by a press of the microphone PTT switch.

The following changes in the FT-227R Instruction Manual should be observed. Apart from these changes, operation is identical to that of the FT-227R.

1. All references to "FT-227R" should read "FT-227RA".
2. The microphone supplied with the FT-227RA contains up/down scanner controls. The microphone plug and jack in the FT-227RA contain 6 pins, compared to 4 pins for the FT-227R.
3. The FT-227RA FUNCTION switch has memory positions M1, M2, M3, and M4, as shown. Also on the FUNCTION switch are $\pm 600\text{kHz}$ repeater positions.
4. The bottom of the cabinet contains the HI/LOW RF output switch, as well as the BUSY-MAN-CLEAR scanning select switch.
5. Page 18, "PLL CONTROL SECTION", should have its first paragraph modified to read: "The optical coupling system utilizes two photo-interruptors Q2 and Q3 (both ON-1105) to generate two signal outputs which are amplified by Q4 and Q5 (both 2SC1815Y) and applied to the PLL control unit.
6. The FT-227RA block diagram, schematic diagram, and parts list should be referred to for correct information.

FT-227RA OPERATION

For scanner operation, proceed as follows. Place the BUSY-MAN-CLEAR switch in the MAN position, and the MR switch should be OFF. Pressing the UP button for an instant will cause a shift of 10kHz upwards. Holding the UP button down for more than $\frac{1}{2}$ second will initiate scanning higher in frequency. Press the UP button once again to halt the scan at the desired frequency.

Pressing the DN switch in the same manner will cause scanning toward a lower frequency.

Placing the scanning select switch in the BUSY position will cause the scan to be halted whenever the squelch is tripped by a signal on the frequency being scanned. Placing the switch in the CLEAR position will cause the scan to be halted when the receiver is muted (no signal present). When the optional tone squelch is used, the scan will be halted according to the condition of the main squelch, not the tone squelch.

For memory operation, proceed as follows. Memory channels M1 – M3 are for simplex operation only. With the MR switch OFF, dial in the desired frequency, press M, and then the frequency will be stored in the channel selected by the FUNCTION switch. For instant return to the simplex frequency, press MR.

Memory channel M4 can be used for repeater operation. Store the repeater UPLINK (input) frequency in channel M4, then rotate the dial to the repeater downlink frequency. With the MR switch OFF, you will now be transmitting on the memorized frequency, and receiving on the dial frequency. Pressing the MR button puts you on the memorized frequency for both transmit and receive.

The $\pm 600\text{kHz}$ positions of the FUNCTION switch are used only for securing repeater offset on the dial frequencies.

For selection of 10 watts or 1 watt of RF output, place the HI/LOW switch in the HI or LOW position, respectively.



OZ 2 EV
JAN ANDREASSEN
 28. KORSGÅRDSVEJ
 DK-2920 CHARLOTTENLUND
 DENMARK

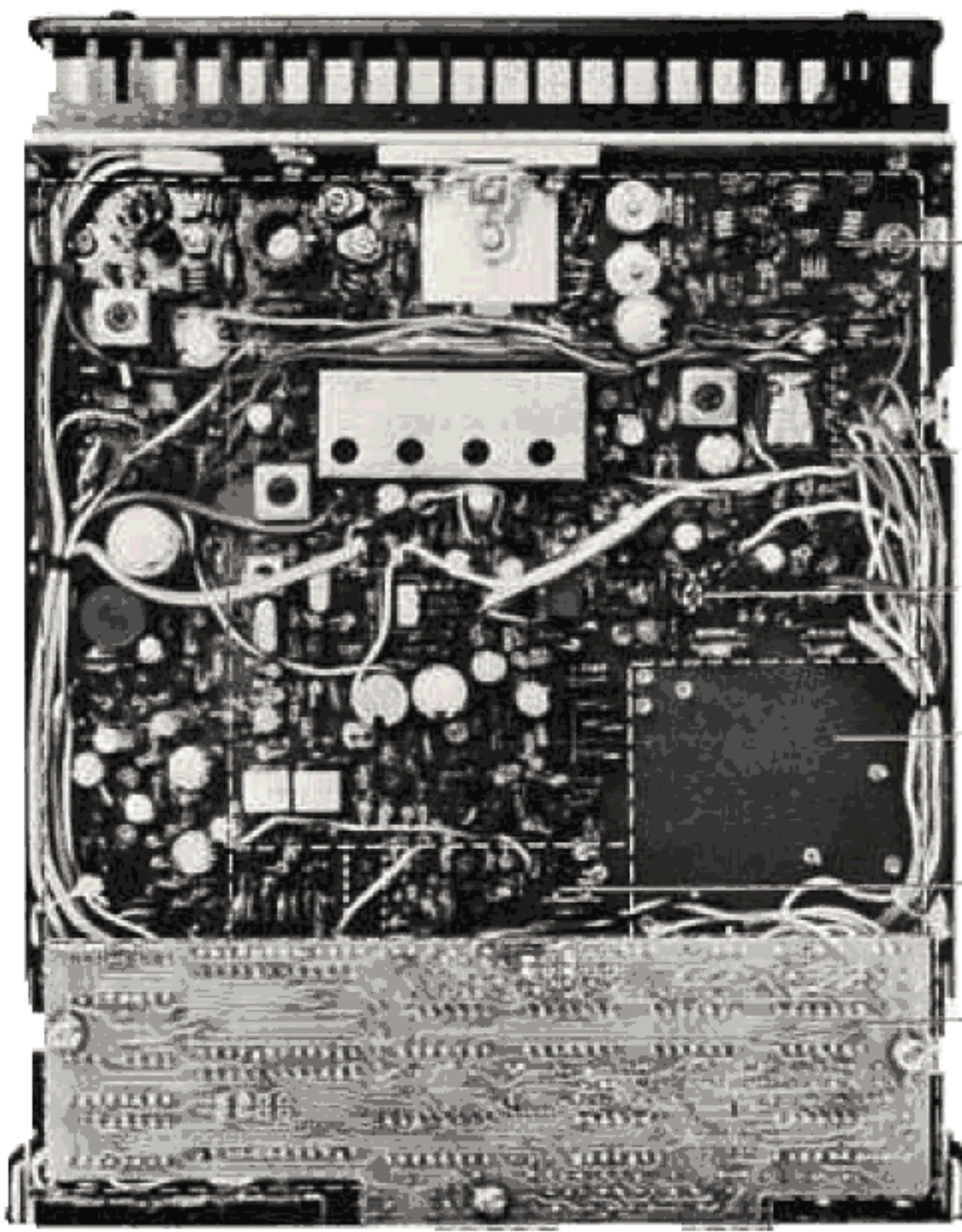

- MAIN UNIT TRANSMITTER SECTION
- MAIN UNIT SECTION RECEIVER
- RED WIRE MUST BE CUT WHEN TONE SQUELCH UNIT IS INSTALLED.
- TONE SQUELCH UNIT (WHEN INSTALLED)
- TONE BURST SECTION
- PLL CONTROL UNIT

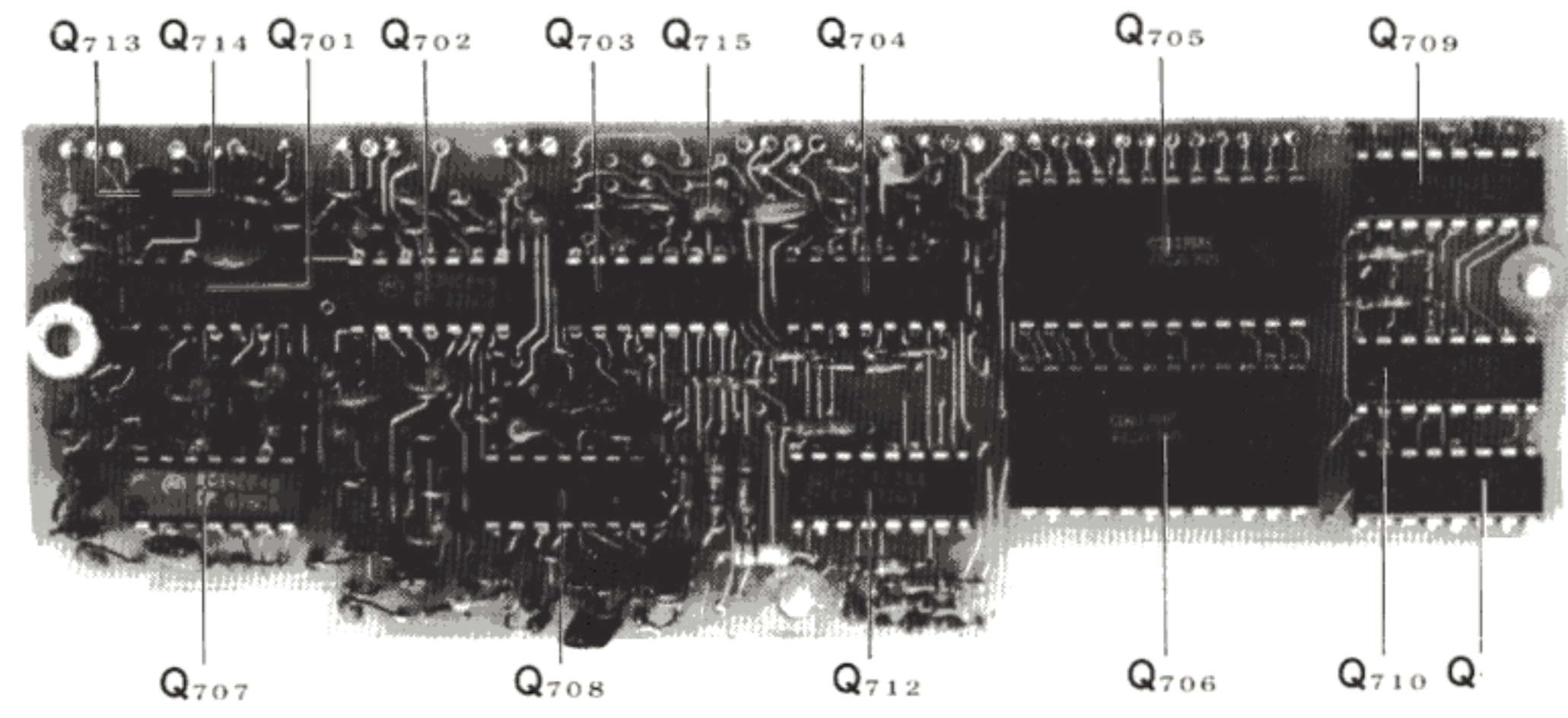

PLL CONTROL UNIT

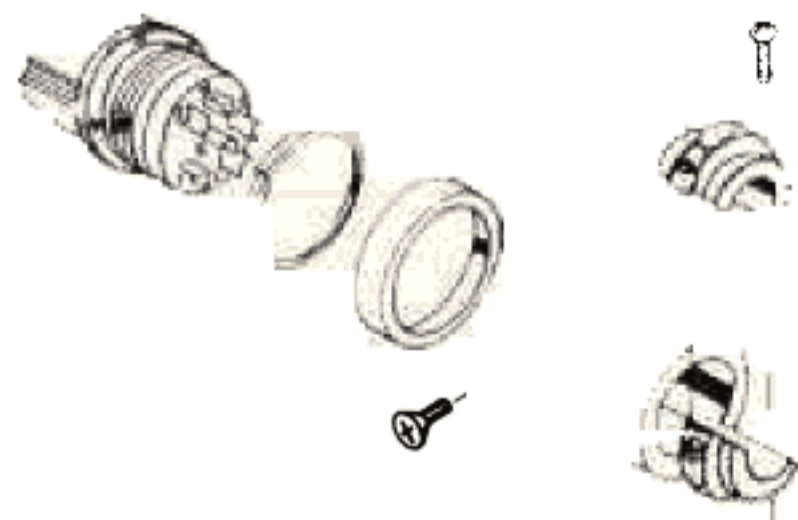
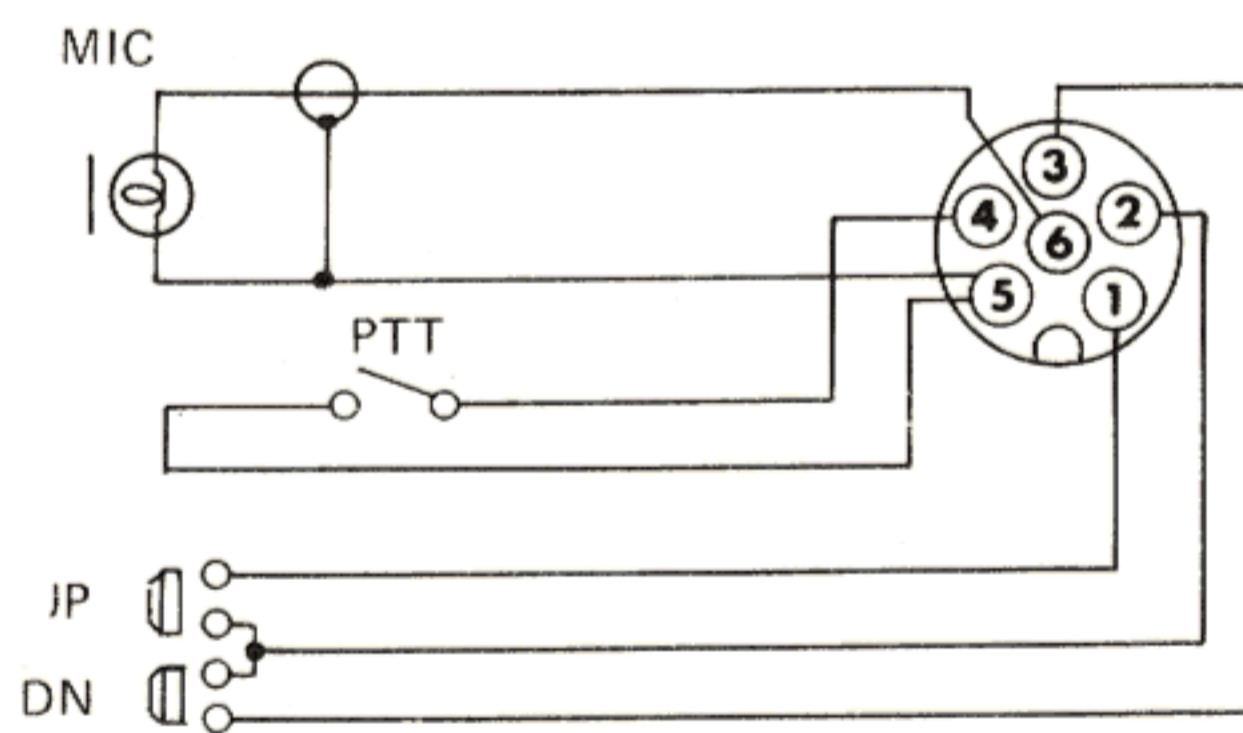

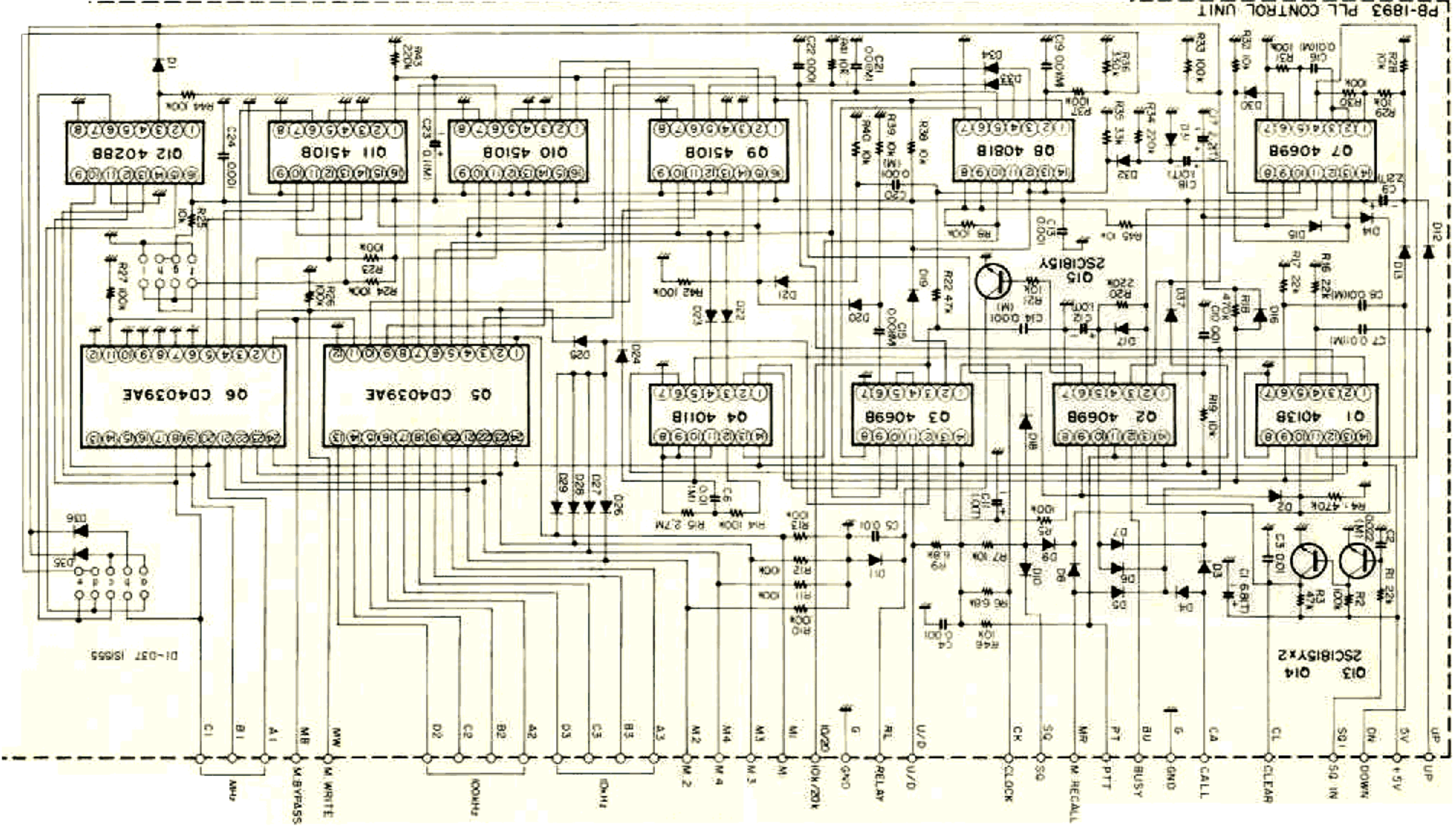

FT-227RA PARTS LIST

MAIN CHASSIS			PHOTO INTERRUPTER BOARD		
Symbol Number	Parts Number	Description	Symbol Number	Parts Number	Description
		TRANSISTOR			
Q1	22402353	2SD235	PB-1850	60318500	Photo interrupter board with components P.C. Board
		DIODE			TRANSISTOR
D5~7	21015550	Silicon 1S1555	Q4,5	22318154	2SC1815Y
D1	21090130	" U05B			
D2	21090111	Zener WZ050			
		RESISTOR			PHOTO INTERRUPTER
R2	41143100	Carbon film 1/4W TJ 10Ω	Q2,3	29090014	ON1105
R1	41143821	" " " " 820Ω			RESISTOR
R6	41143562	" " " " 5.6KΩ	R11,13	40143221	Carbon film 1/4W VJ 220Ω
R7	42124220	*Composition 1/2W GK 22Ω	R12,14	40143103	" " " " 10KΩ
		POTENTIOMETER			
VR1(with S1)	49800079	DM11A-5M1111 10KΩB/10KΩA			
		CAPACITOR			SWITCH BOARD
C1	31829150	Ceramic disc 50WV 15PF (SI.)	Symbol Number	Parts Number	Description
C10	30820102	" " " 0.001μF		018960AZ	SW board with components
C2,3	30820103	" " " 0.01μF	PB-1896	60318960	P.C. Board
C7	34120107	Electrolytic 10WV 100μF			
C6	34220106	" 16WV 10μF			DIODE
C5	34220226	" " 22μF	D8	21015550	Silicon 1S1555
C4	34220107	" " 100μF	D3,4	21090111	Zener WZ050
		INDUCTOR			RESISTOR
L1	55003160	# 220196	R3	40143103	Carbon film 1/4W VJ 10KΩ
		AF CHOKE			CAPACITOR
CH1	50000010	# 230012	C8,9	34220106	Electrolytic 16WV 10μF
		METER			SWITCH
M1(with PL6)	74000310	AP-120	S2,3,5	65000032	2U-EE-20
			S4	65000044	2U-OA-20
		SPEAKER			
SP1	76000013	SM-77K-Y			
		SWITCH			
S6,7	63000008	SSF-22-08B			
S8	63000011	SSH-23-08			
S1(with VR1)	-				
		RECEPTACLE			
J1	68020006	FM142S			
J2	68060002	FM146S			
J3	68050003	CS250			
J4	68000007	JS0239			
J5	68020012	SG8050			
		LAMP			
PL1-5,7	14000025	BQ054-32732B 14V 40mA			
PL6(with M1)	-				

OZ 2 EV
 JAN ANDREASSEN
 28, KORSGÅRDSVEJ
 DK-290 CHARLOTTENLUND
 DENMARK

FT-227RA PARTS LIST

PLL CONTROL UNIT			ACCESSORIES		
Symbol Number	Parts Number	Description	Symbol Number	Parts Number	Description
	018930AZ	PLL Control unit with components		97000017	Microphone Assembly YE-17
PB-1893	60518930	P.C. Board			with Microphone hanger, screws
				67060001	Microphone plug FM-146P
		IC & TRANSISTOR			
Q704	25000114	IC MC14011B		67050003	ACC Plug CP0084
Q701	25000113	" MC14013B			
Q712	25000136	" MC14028B		96000020	Power cord Assembly #240028
Q702, 703, 707	25000178	" MC14069B		67020006	Power plug FM142P
Q708	25000093	" MC14081B		69020002	Fuse Holder SN1101
Q709~711	25000091	" MC14510B		73000003	Fuse 3A
Q705, 706	25000192	" CD4039AE			
Q713~715	22318154	Transistor 2SC1815Y		67020008	Cigarette Lighter Adapter
				73000003	Fuse 3A
		DIODE			
D701~737	21015550	Silicon 1S1555		67020003	External Speaker plug P-2240
		RESISTOR		93100046	Tap connector No.560
R714	40143472	Carbon film 1/4W VJ 4.7KΩ			
R706, 709	40143682	" " " " 6.8KΩ		80038631	Stand
R707, 719, 728, 729	40143103	" " " " 10KΩ			
R732, 738, 741, 746				80038661	Mobile Bracket Assembly with Set Screws
R721, 725, 739, 740, 745	41143103	" " " TJ 10KΩ			
R701, 716, 717	40143223	" " " VJ 22KΩ			
R735	41143333	" " " TJ 33KΩ			
R703, 722	40143473	" " " VJ 47KΩ			
R702, 705, 730, 731	40143104	" " " " 100KΩ			
R733, 737, 744					
R708, 710~713, 723	41143104	" " " TJ 100 KΩ			
R724, 726, 727, 742					
R720, 734	40143224	" " " VJ 220KΩ			
R744	41143224	" " " TJ 220KΩ			
R704, 718	40143474	" " " VJ 470KΩ			
R715	42144275	" composition 1/4W GK 2.7MΩ			
		CAPACITOR			
C704, 713, 722, 724	30820102	Ceramic disc 50WV 0.001μF			
C703, 705, 710	30820103	" " " " 0.01μF			
C714, 715, 720	36825102	Mylar " " 0.001μF			
C706~708, 716, 719	36825103	" " " " 0.01μF			
C721					
C702	36825223	" " " " 0.022μF			
C723	36526104	Tantalum 35WV 0.1μF			
C711, 712, 713	36526105	" " " " 1μF			
C709, 717	36526225	" " " " 2.2μF			
C701	36326685	" (N.L) 20WV 6.8μF			

OZ 2 EV
JAN ANDREASSEN
 28, KORSGÅRDSVEJ
 DK-2920 CHARLOTTEENLUND
 DENMARK

TRANSISTOR & IC CONNECTIONS

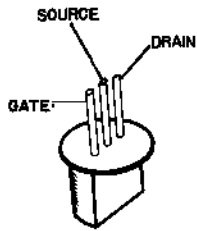

2SK19Y
2SK19GR

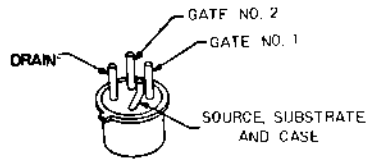

3SK40M
3SK51

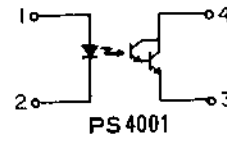
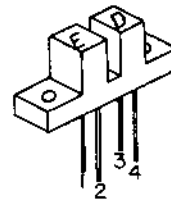

PS4001

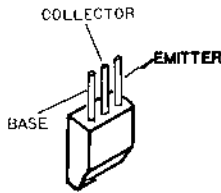

2SC535A

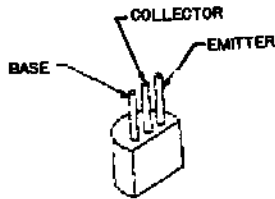

2SA564A

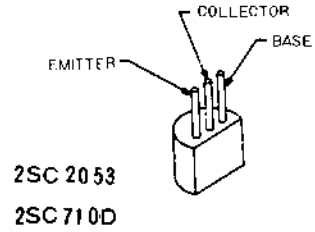

2SC2053
2SC710D

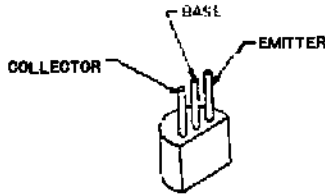

MPSA13

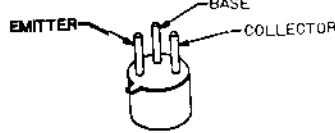

2SC730

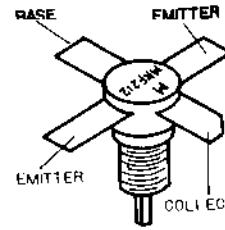

MRF212

CORNER IS CUT
AT 45° ANGLE

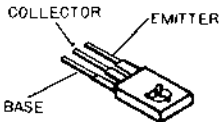

COLLECTOR
BOTTOM SURFACE)
2SA496O

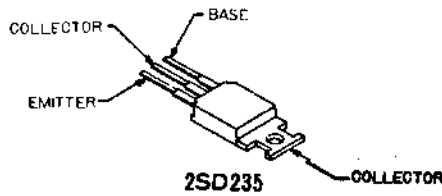

2SD235

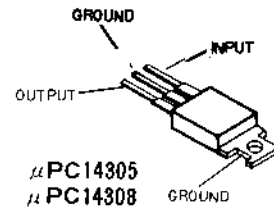

PC14305
PC14308

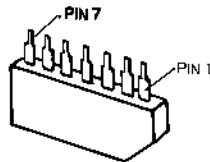

PC577H

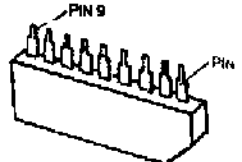

TC5081

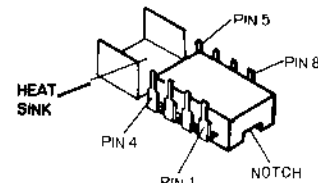

PC575C2

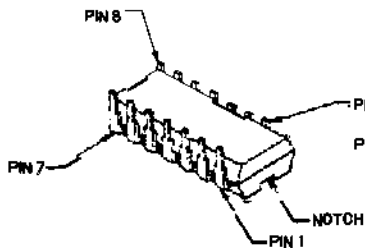

MC14011B
MC14081B

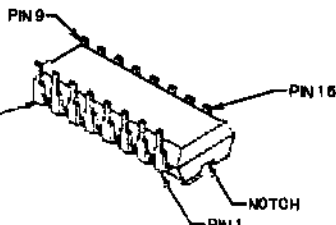

MSM561 MC14049B
MC14008B MC14510B
MC14028B MC14511B
MC14042B MC14519B

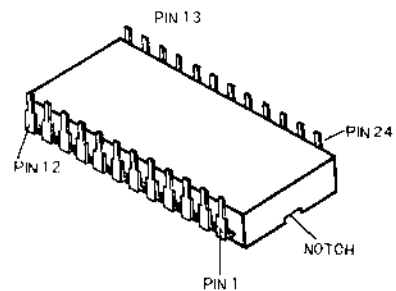

PD857C

Q308 (μ PD857C) PROGRAMMABLE DIVIDER CODE

Q308 PROGRAMMABLE INPUT PIN →			1	2	3	4	5	6	7	8	9	10	11
P/J305 →			4	5	6	7	8	9	10	11	12	13	14
P/J304 →			11	10	9	8	7	6	5	4	3	2	1
FREQUENCY ↓	DIAL DISPLAY ↓	PROGRAMMABLE DIVIDER RATIO ↓	P ₁	P ₂	P ₃	P ₄	P ₅	P ₆	P ₇	P ₈	P ₉	P ₁₀	P ₁₁
			144.00	4.000	1/100	0	0	0	0	0	0	0	0
4.01	4.010	1/101	1	0	0	0	0	0	0	0	1	0	0
4.02	4.020	1/102	0	1	0	0	0	0	0	0	1	0	0
4.03	4.030	1/103	1	1	0	0	0	0	0	0	1	0	0
4.04	4.040	1/104	0	0	1	0	0	0	0	0	1	0	0
4.05	4.050	1/105	1	0	1	0	0	0	0	0	1	0	0
4.06	4.060	1/106	0	1	1	0	0	0	0	0	1	0	0
4.07	4.070	1/107	1	1	1	0	0	0	0	0	1	0	0
4.08	4.080	1/108	0	0	0	1	0	0	0	0	1	0	0
4.09	4.090	1/109	1	0	0	1	0	0	0	0	1	0	0
144.10	4.100	1/110	0	0	0	0	1	0	0	0	1	0	0
4.11	4.110	1/111	1	0	0	0	1	0	0	0	1	0	0
4.12	4.120	1/112	0	1	0	0	1	0	0	0	1	0	0
4.13	4.130	1/113	1	1	0	0	1	0	0	0	1	0	0
4.14	4.140	1/114	0	0	1	0	1	0	0	0	1	0	0
4.15	4.150	1/115	1	0	1	0	1	0	0	0	1	0	0
4.16	4.160	1/116	0	1	1	0	1	0	0	0	1	0	0
4.17	4.170	1/117	1	1	1	0	1	0	0	0	1	0	0
4.18	4.180	1/118	0	0	0	1	1	0	0	0	1	0	0
4.19	4.190	1/119	1	0	0	1	1	0	0	0	1	0	0
144.20	4.200	1/120	0	0	0	0	0	1	0	0	1	0	0
4.30	4.300	1/130	0	0	0	0	1	1	0	0	1	0	0
4.40	4.400	1/140	0	0	0	0	0	0	1	0	1	0	0
4.50	4.500	1/150	0	0	0	0	1	0	1	0	1	0	0
4.60	4.600	1/160	0	0	0	0	0	1	1	0	1	0	0
4.70	4.700	1/170	0	0	0	0	1	1	1	0	1	0	0
4.80	4.800	1/180	0	0	0	0	0	0	0	1	1	0	0
4.90	4.900	1/190	0	0	0	0	1	0	0	1	1	0	0
145.00	5.000	1/200	0	0	0	0	0	0	0	0	0	1	0
145.01	5.010	1/201	1	0	0	0	0	0	0	0	0	1	0
145.02	5.020	1/202	0	1	0	0	0	0	0	0	0	1	0
145.03	5.030	1/203	1	1	0	0	0	0	0	0	0	1	0
145.04	5.040	1/204	0	0	1	0	0	0	0	0	0	1	0
145.05	5.050	1/205	1	0	1	0	0	0	0	0	0	1	0
145.06	5.060	1/206	0	1	1	0	0	0	0	0	0	1	0
145.07	5.070	1/207	1	1	1	0	0	0	0	0	0	1	0
145.08	5.080	1/208	0	0	0	1	0	0	0	0	0	1	0
145.09	5.090	1/209	1	0	0	1	0	0	0	0	0	1	0
145.10	5.100	1/210	0	0	0	0	1	0	0	0	0	1	0
145.20	5.200	1/220	0	0	0	0	0	1	0	0	0	1	0
145.30	5.300	1/230	0	0	0	0	1	1	0	0	0	1	0
145.40	5.400	1/240	0	0	0	0	0	0	1	0	0	1	0
145.50	5.500	1/250	0	0	0	0	1	0	1	0	0	1	0
145.60	5.600	1/260	0	0	0	0	0	1	1	0	0	1	0
145.70	5.700	1/270	0	0	0	0	1	1	1	0	0	1	0
145.80	5.800	1/280	0	0	0	0	0	0	0	1	0	1	0
145.90	5.900	1/290	0	0	0	0	1	0	0	1	0	1	0
146.00	6.000	1/300	0	0	0	0	0	0	0	0	1	1	0
147.00	7.000	1/400	0	0	0	0	0	0	0	0	0	0	1
147.99	7.990	1/499	1	0	0	1	1	0	0	1	0	0	1

* 1 HIGH LEVEL (5V)

* 0 LOW LEVEL (0V)

Vi har erfaret at P & T er begyndt at indrage 2 M stationer, der kører ud over 144-146 mhz området. For at undgå dette fremsendes hermed en vejledning, der kan hjælpe til med at gøre ændringen lettere.

Angående ændring af FT 227 RA så denne kun kører 144-146 Mhz. Kortslutningerne på punkterne 1 og 3 fjernes. Punkterne 2 og 5 kortsluttes. Apparatet kører nu kun fra 144-146 Mhz.

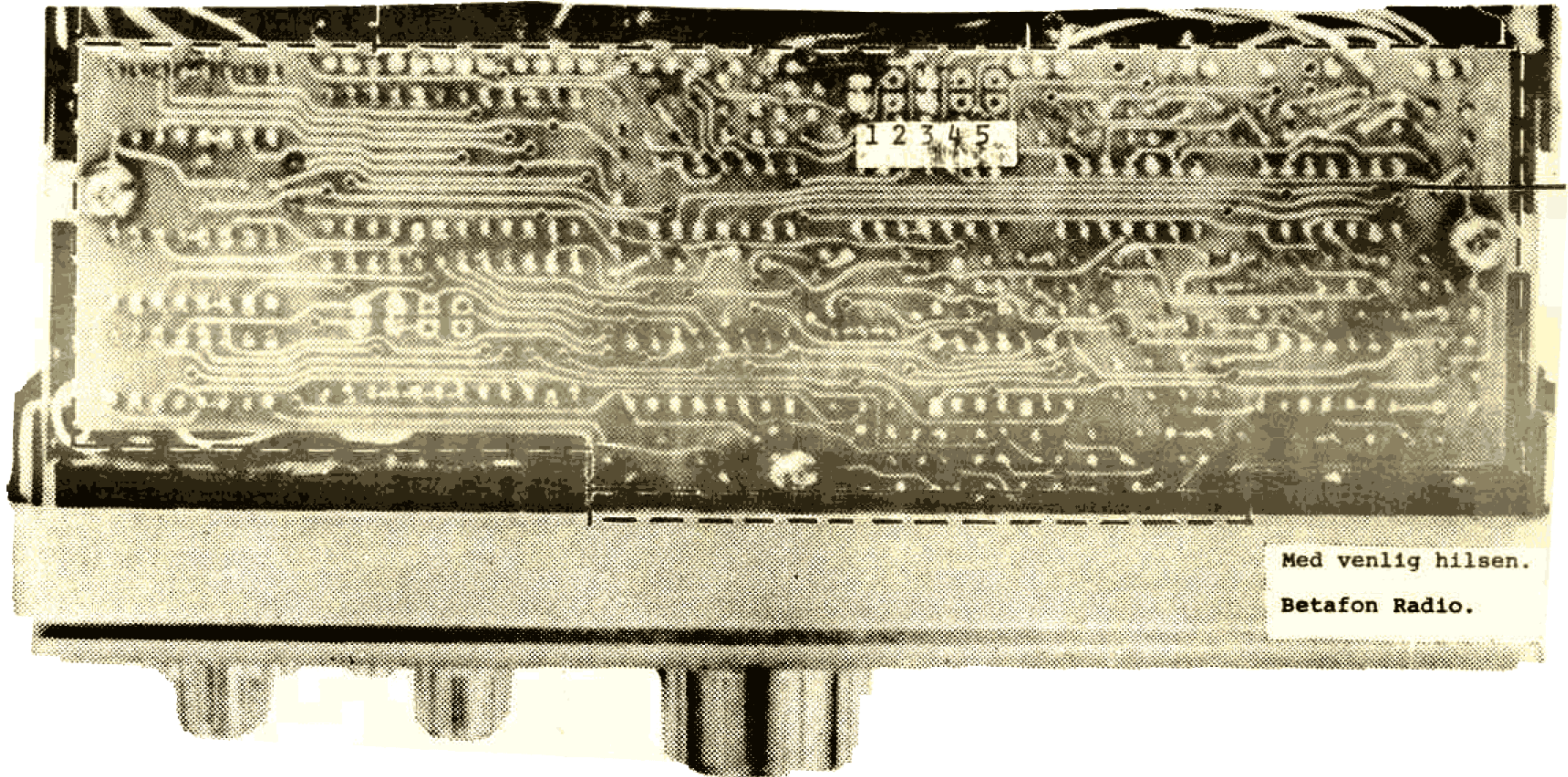

Med venlig hilsen.

Betafon Radio.

ADDENDUM TO FT-227R INSTRUCTION MANUAL

This transceiver has been modified in order to make the tone access feature for repeater operation more convenient for repeater operation in your area. The following changes in operation of your unit should be noted.

1. The TONE SQ feature has been eliminated.
2. The TONE BURST feature has been changed. The necessary tone for accessing repeaters is now provided through the front panel CALL button. Pressing this button activates the transceiver PTT relay and transmits a tone of 1750 Hz for as long as the button is depressed.
3. The rear panel BURST ON-OFF switch has been removed. The CALL feature is always in operation.
4. As in the original model, the audio frequency of the tone may be adjusted by varying VR207.

133.30 ~ 137.29MHz

PB-1757 (PLL UNIT)

PB-1765 (VCO UNIT)

10.7MHz
 1.7V
 1.5MHz
 2.3V
 1.6MHz
 3.0V
 1.47MHz
 3.7V
 1.48MHz
 4.5V

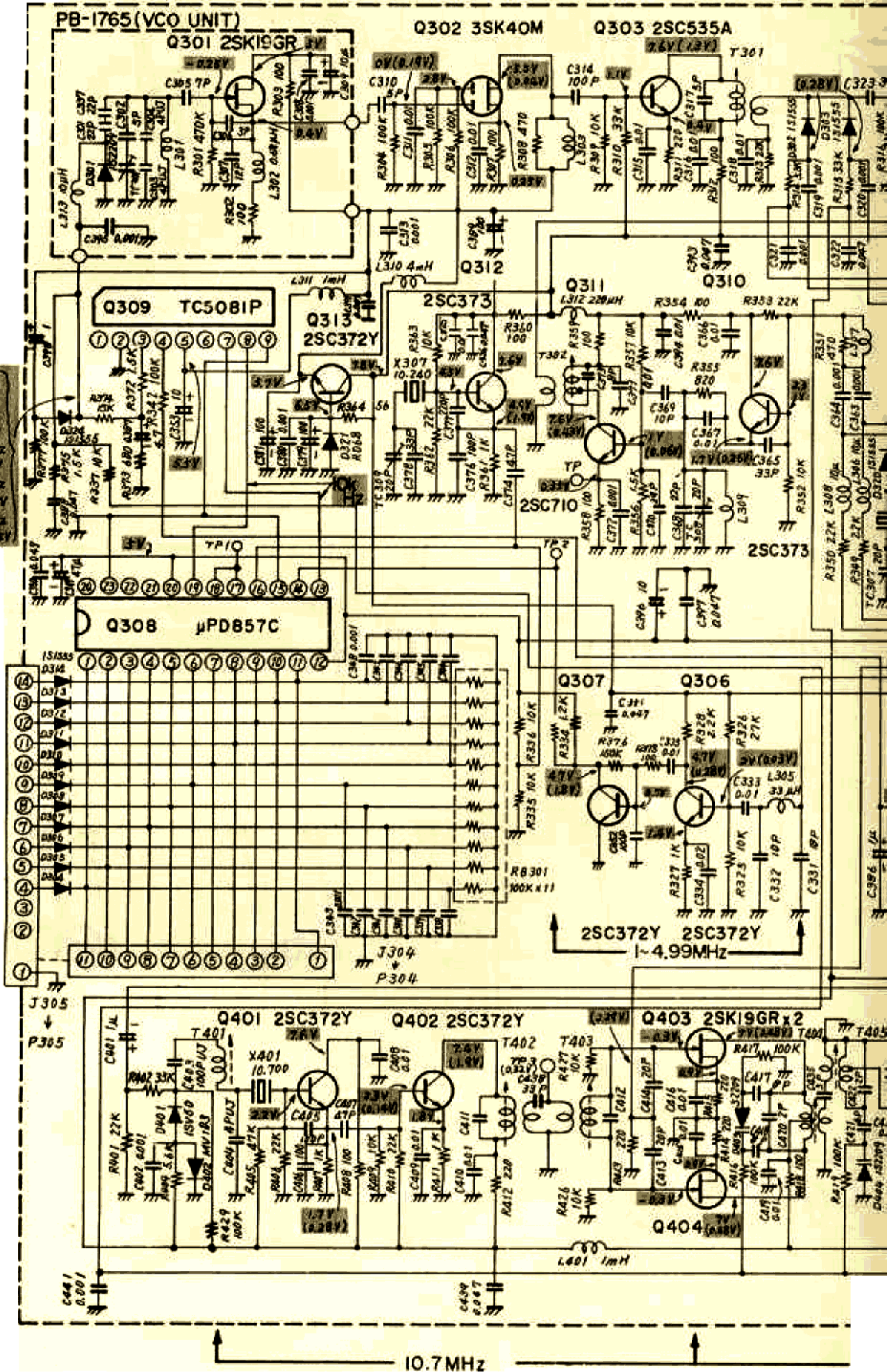

10.7MHz

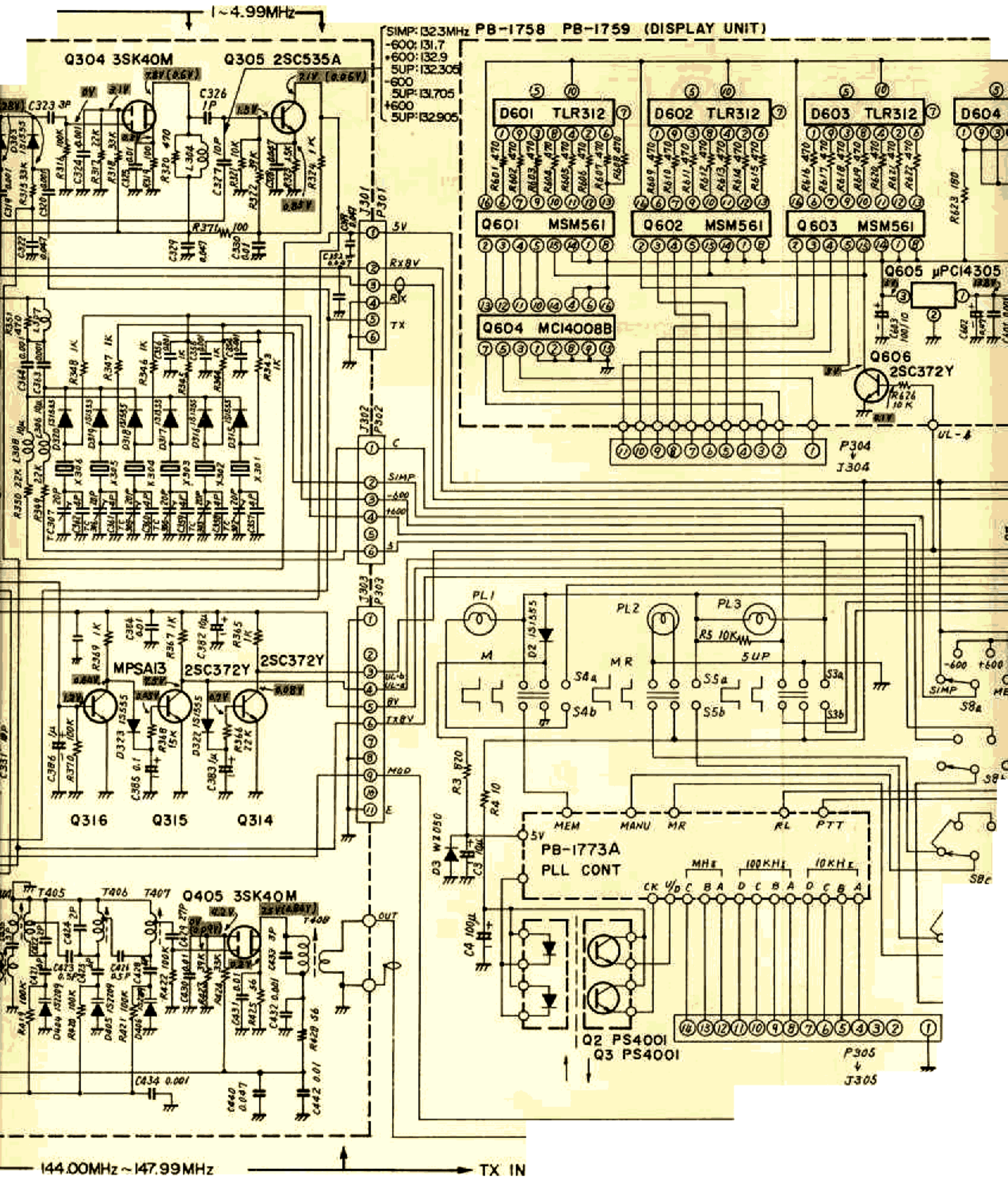

144.00MHz ~ 147.99MHz

10.7MHz

PB-1659 (MAIN UNIT)

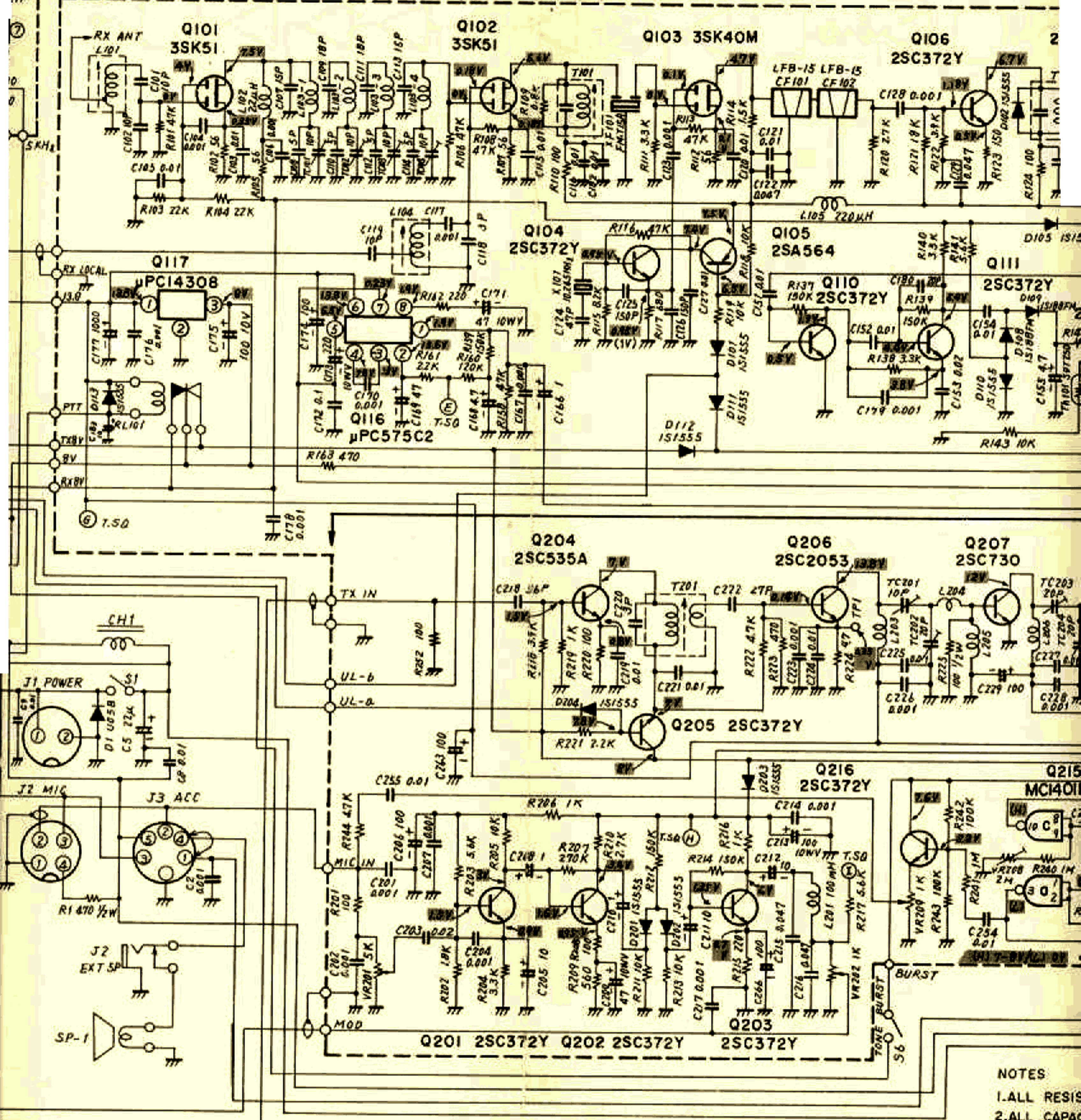

NOTES

- 1. ALL RESIS
- 2. ALL CAPAC
- 3. ALL ELEC
- OTHERWISE
- 4. * VALUE I

— V DC VOLTAGE
 (—V) rms SIGNAL LEVEL
 MEASURED WITH VTVM.

455 kHz

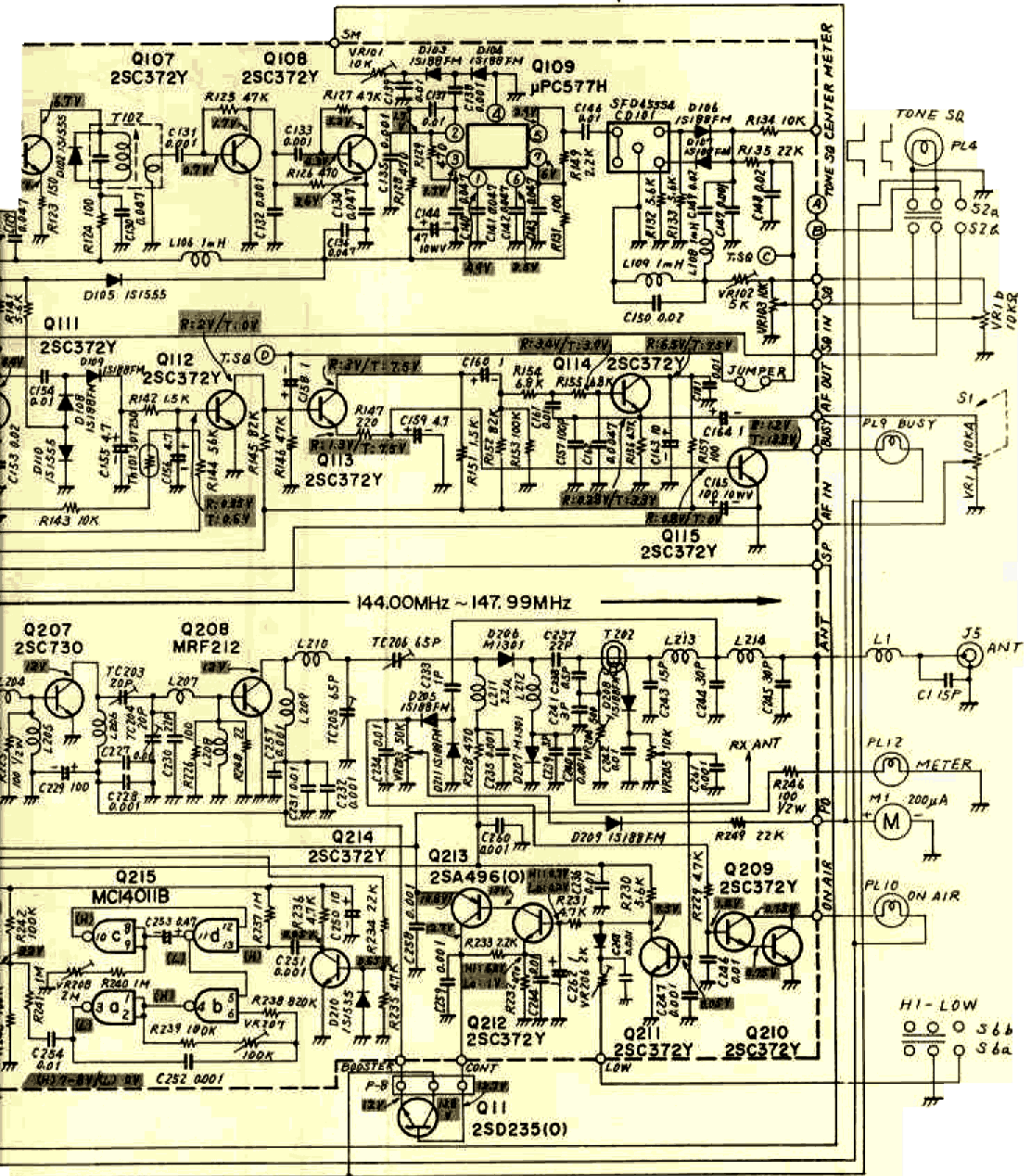

NOTES

1. ALL RESISTORS ARE IN 1/4W UNLESS OTHERWISE NOTED.
2. ALL CAPACITORS ARE IN µF UNLESS OTHERWISE NOTED.
3. ALL ELECTROLYTIC CAPACITORS ARE 16WV UNLESS OTHERWISE NOTED
4. * VALUE IS NOMINAL.

FT-227R
CIRCUIT DIAGRAM

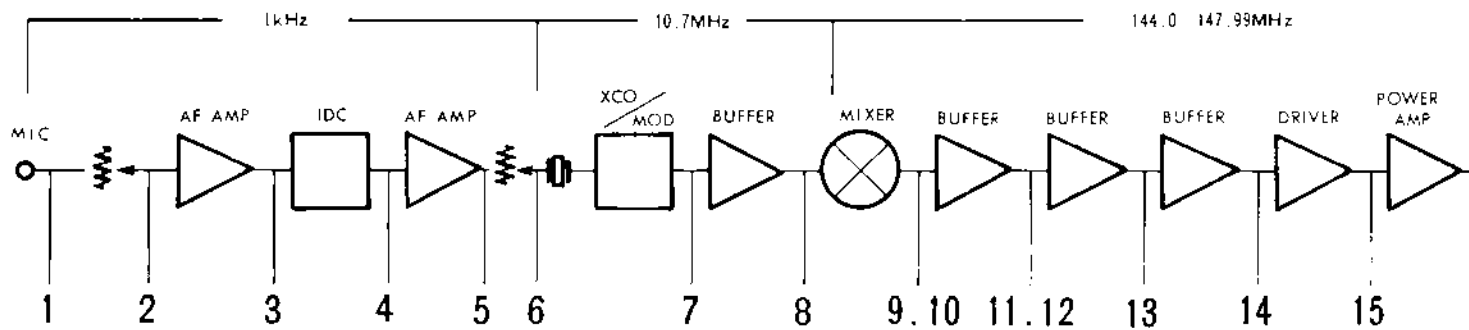

TRANSMITTER SECTION

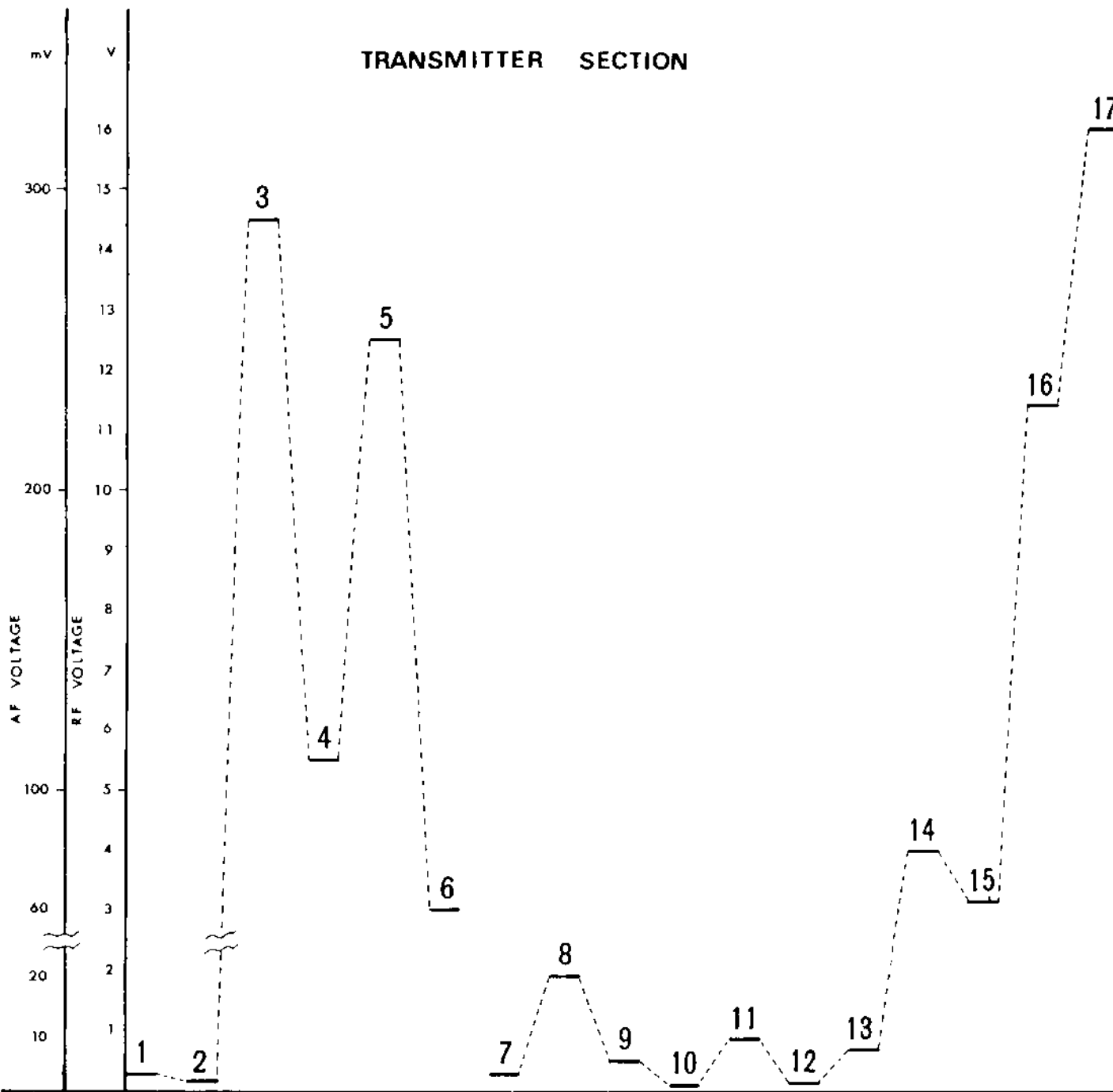

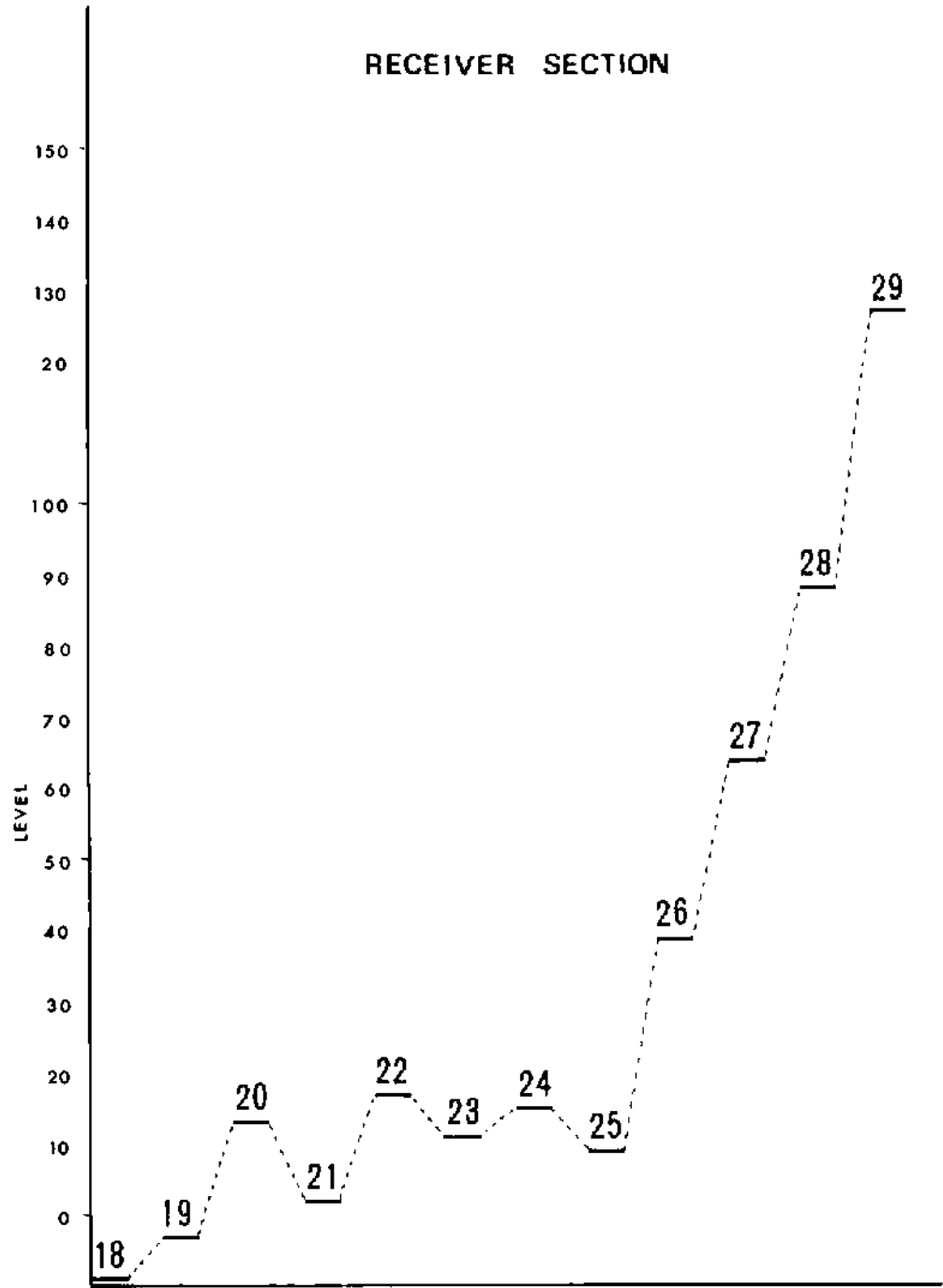
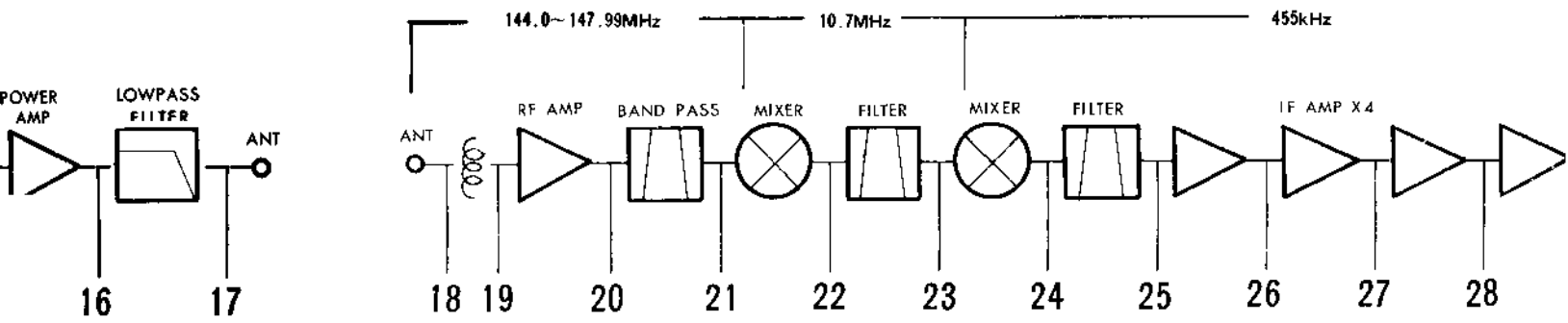

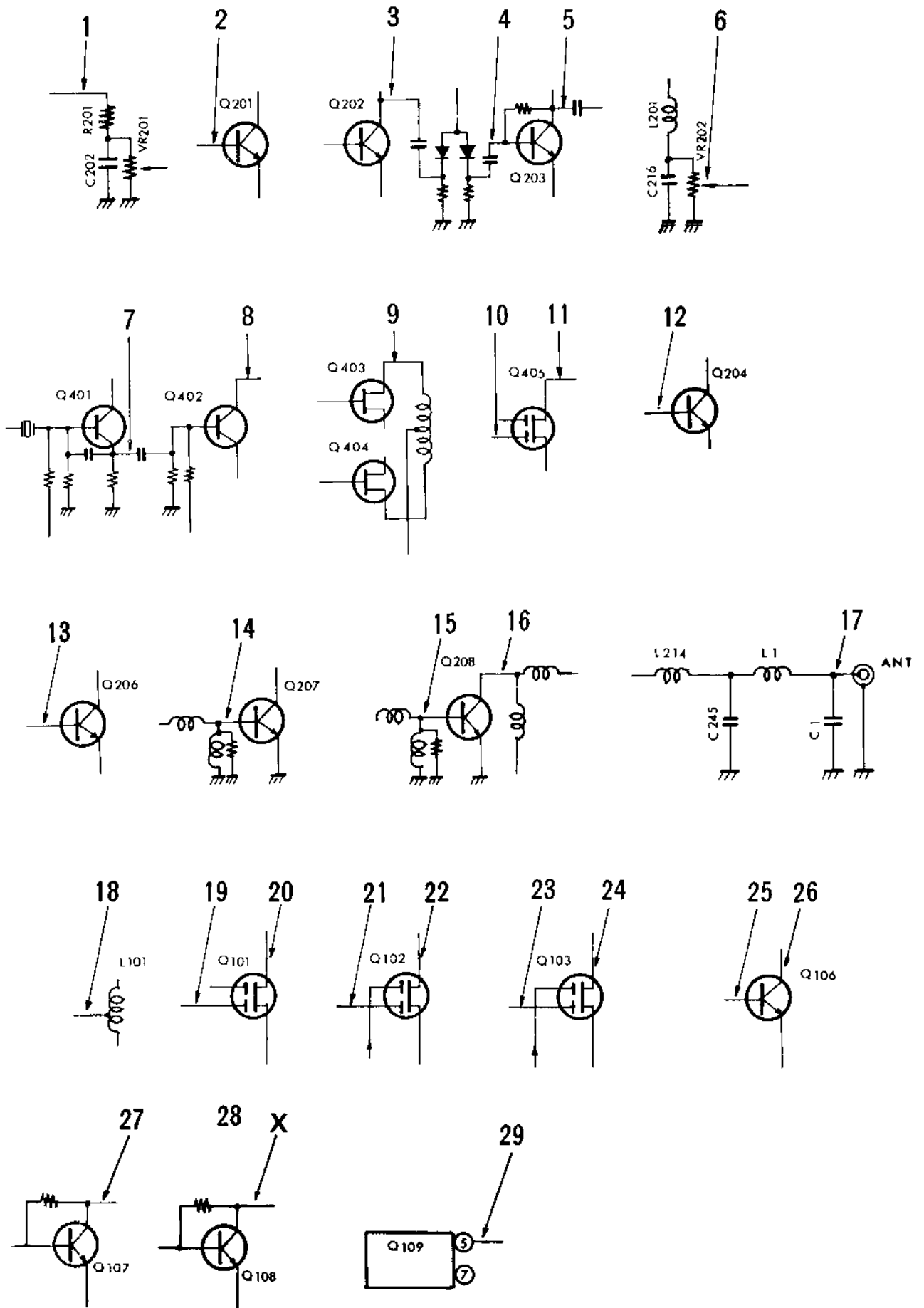

LEVEL DIAGRAM

PB-1757A (PLL UNIT)

PB-1765C (VCO UNIT)

Q302 3SK40M

Q303 2SC535A

Q304 3SK40M

Q301 2SK19BL

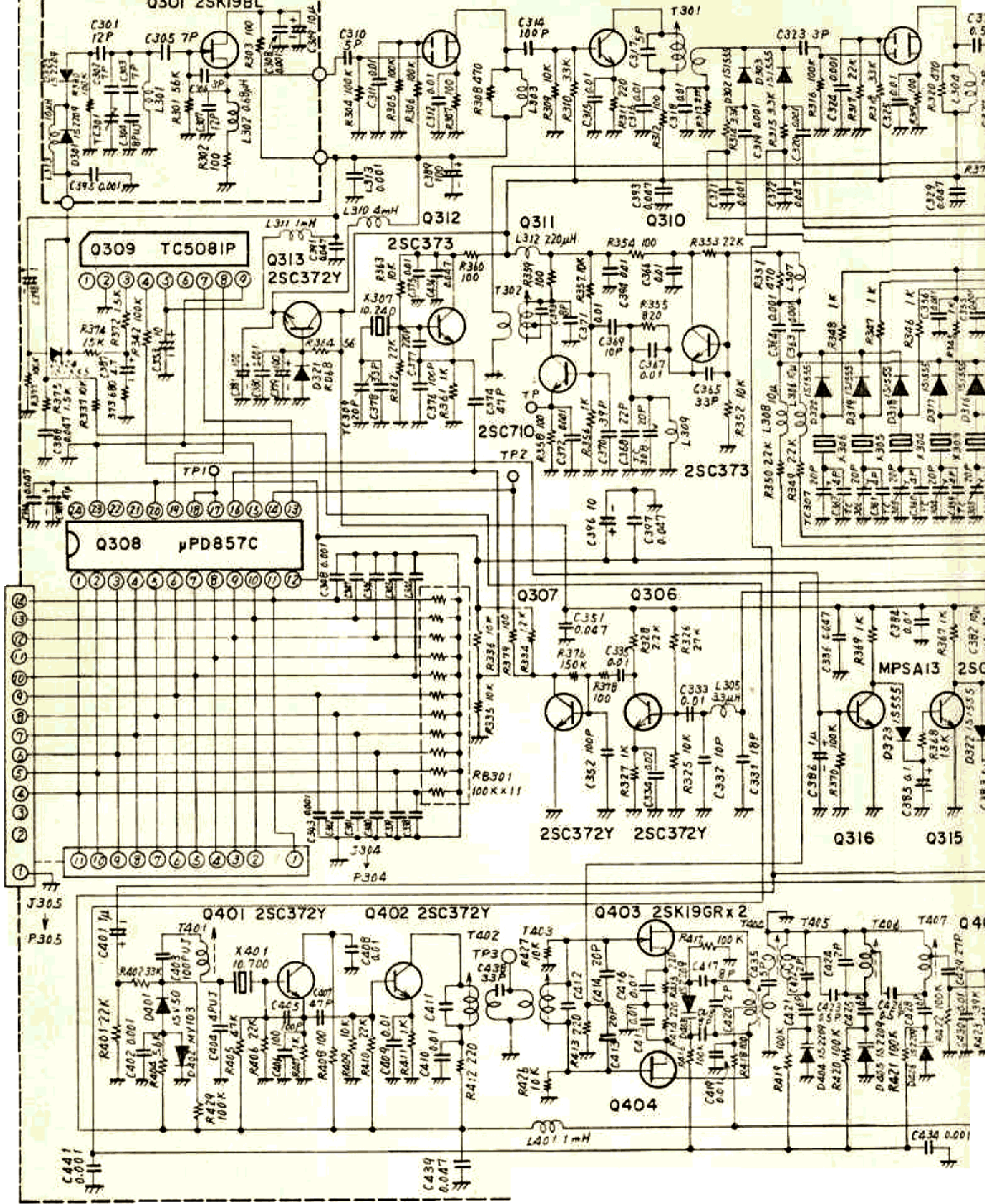

PB-1758 PB-1759 (DISPLAY UNIT)

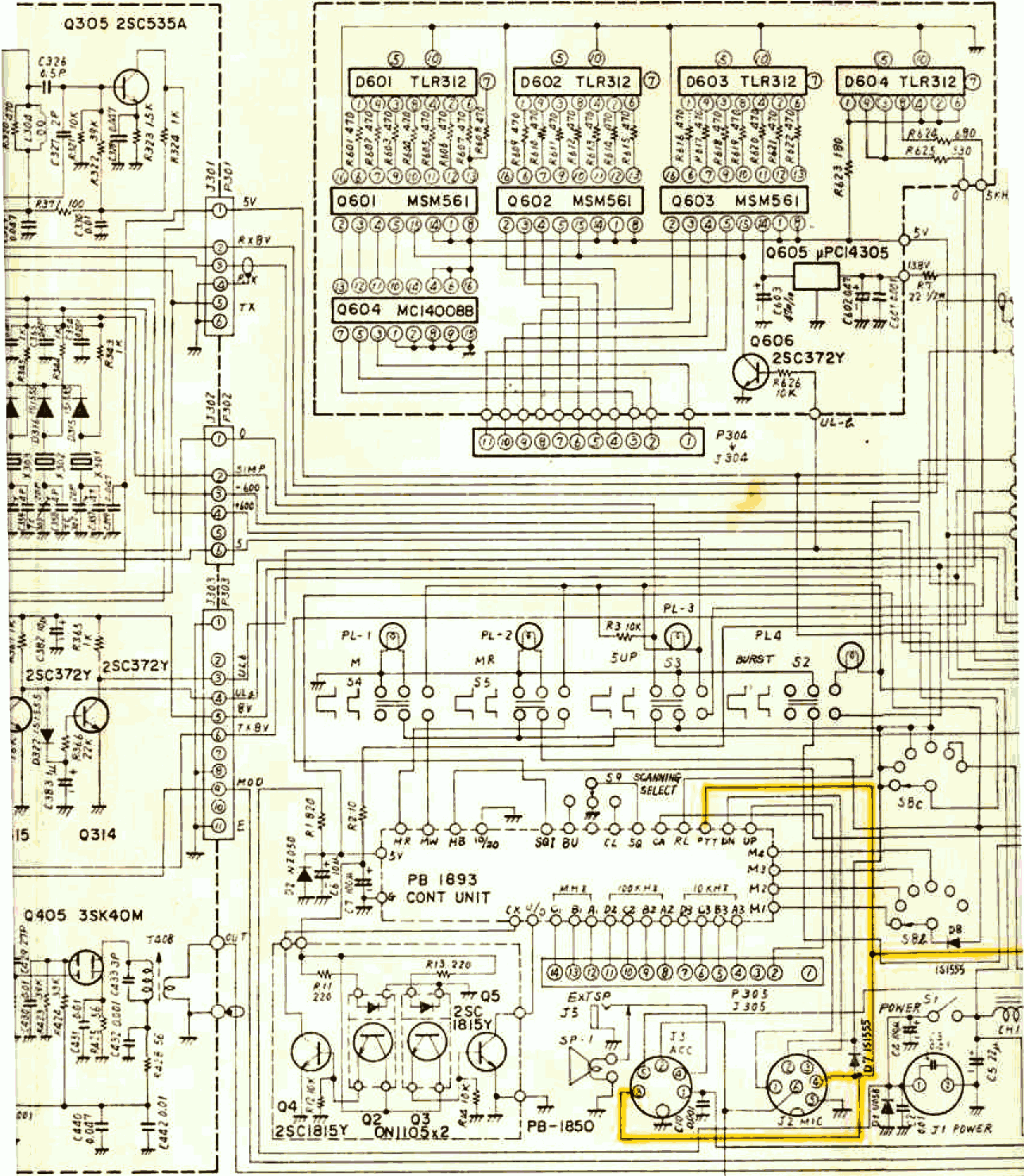

PB-1659C (MAIN UNIT)

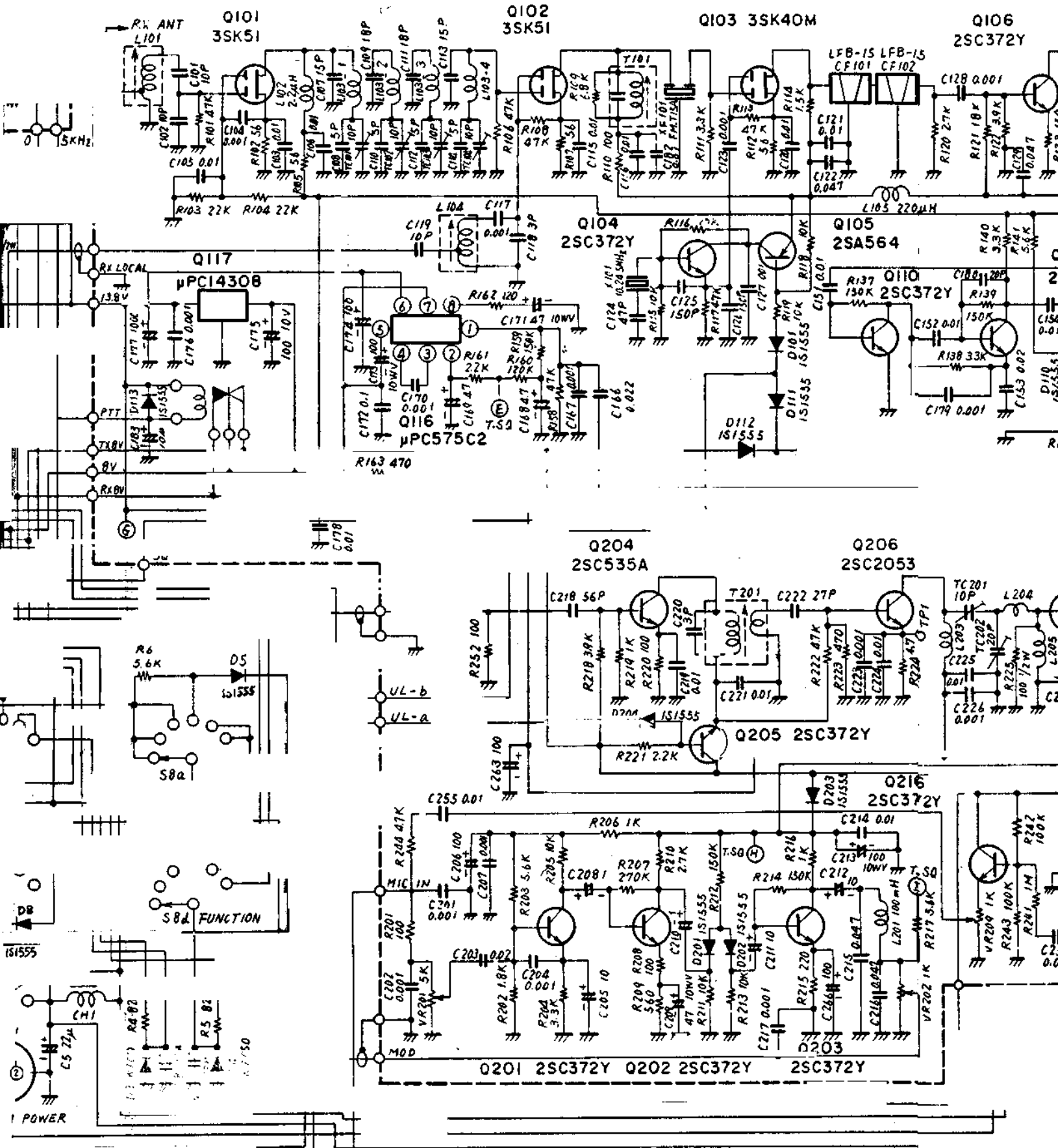

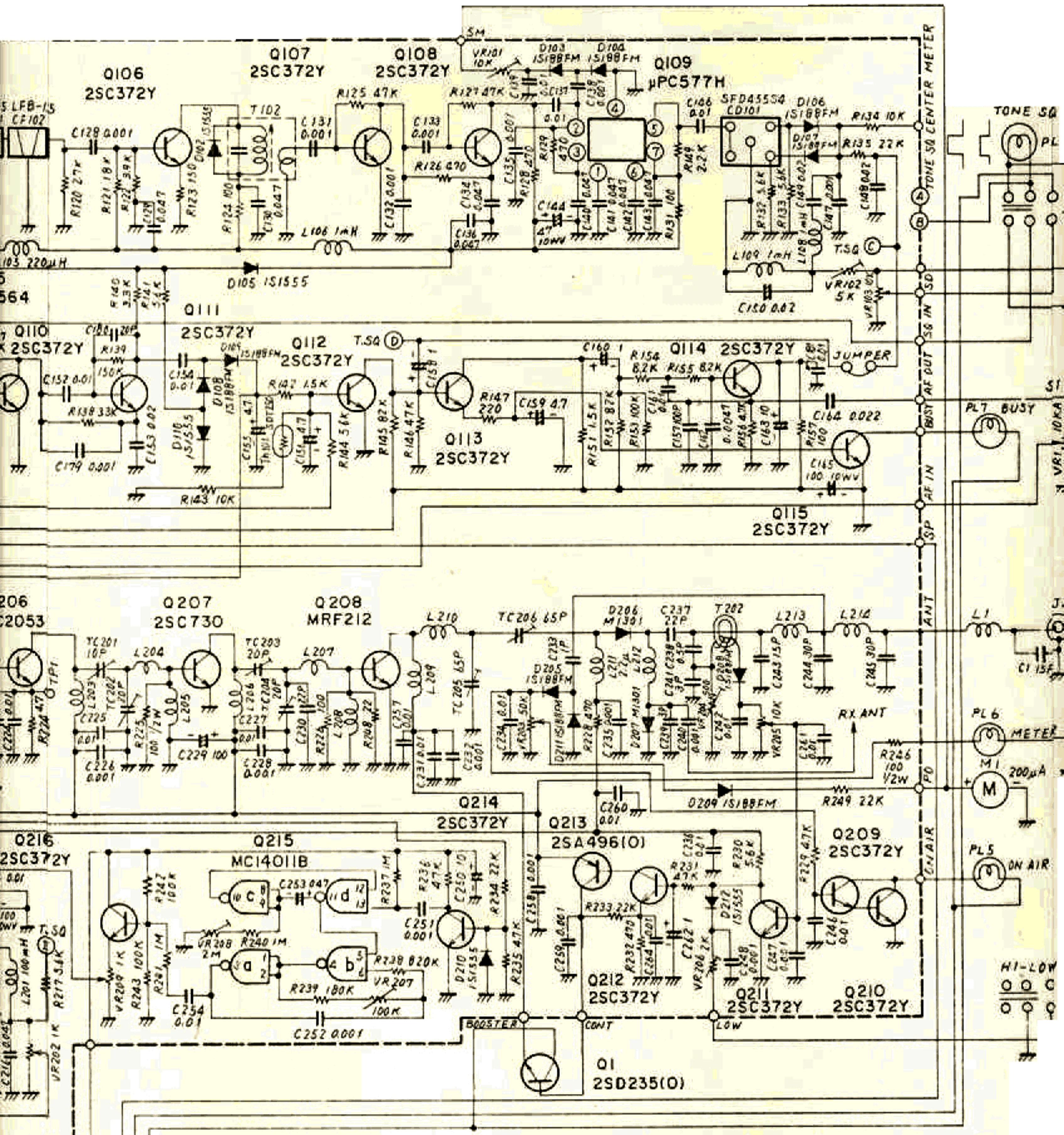

NOTES

1. ALL RESISTORS ARE IN 1/4W UNLESS OTHERWISE NOTED.
2. ALL CAPACITORS ARE IN μF UNLESS OTHERWISE NOTED.
3. ALL ELECTROLYTIC CAPACITORS ARE 16 WV UNLESS OTHERWISE NOTED
4. * VALUE IS NOMINAL.

**FT-227RA
CIRCUIT DIAGRAM**

