

### USE AND DISTRIBUTION NOTICE

- Santa Clara County RACES authorization is granted to use and duplicate this material as-is as long as this page and the copyright notices on each page are included, acknowledging Santa Clara County ARES/RACES as the holder of the copyright.
- Permission is granted to adapt this presentation to your needs as long as you acknowledge our copyright and include a note similar to "adapted with permission from Santa Clara County ARES/RACES"
- For additional information on training or any of our programs send an email to: [info@scc-ares-races.org](mailto:info@scc-ares-races.org)

Copyright (C) 2018 Santa Clara County ARES/RACES. All rights reserved.

1

---

---

---

---

---

---

---

---

---

---



## 2018 Year End Summary, Update, Preview



Santa Clara County ARES®/RACES  
Revised: 05-Dec-2018

ARES and Amateur Radio Emergency Service are registered service marks of the American Radio Relay League Incorporated and are used by permission.  
Copyright (C) 2018 Santa Clara County ARES/RACES. All rights reserved.

2

---

---

---

---

---

---

---

---

---

---

### Housekeeping

- Introductions
- Pen/pencil & paper
- Cell phones on silent or vibrate
- Side conversations
- Questions
- No food or drink in room
  - water only
- Breaks
- Restrooms
- In case of emergency

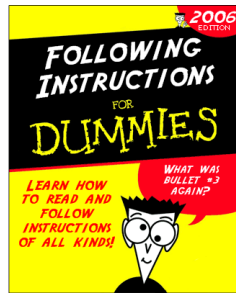

Copyright (C) 2018 Santa Clara County ARES/RACES. All rights reserved.

3

---

---

---

---

---

---

---

---

---

---

**Agenda**

- Training
- Field Operations
- Message Passing
- Net Control and Procedures
- Packet Networking
- County Wide Drill Recap
- SCCo Data Network Update
- Amateur Radio for Emergency Managers



Copyright (C) 2018 Santa Clara County ARES/RACES. All rights reserved.

---

---

---

---

---

---



---

---

---

---

4

**Training**  
2018 Year End Summary, Update



Santa Clara County ARES®/RACES  
Tim Howard, KE6TIM  
Revised: 05-Dec-2018

ARES and Amateur Radio Emergency Service are registered service marks of the American Radio Relay League Incorporated and are used by permission.  
Copyright (C) 2018 Santa Clara County ARES/RACES. All rights reserved.

---

---

---

---

---

---

---

---

---

---

5

**2018 Review**

- 63 hours of classroom training was offered
- 545 attendees (not including today's class)
- 34,335 contact hours
- 162 Unique Individuals
- Courses will continue to evolve and improve
  - Based on observations and changes to procedures
  - It is a good idea to retake a class every 2-3 years
  - Your feedback is important, please turn in course evaluations
- Please remove yourself from the course sign-up if your plans change
  - Free up a seat for someone else in large classes
  - Room size limitations

Copyright (C) 2018 Santa Clara County ARES/RACES. All rights reserved.

---

---

---

---

---

---

---

---

---

---

6

### 2018 Review

- Additional Field Ops and Message Passing Classes
  - Now offered twice each year
  - Pre-requisite for other classes
  
- Created video training on ICS-214 Unit Activity Log
  - Other forms to consider: 211, 205, 309, ??
  - What are your thoughts?

Copyright (C) 2018 Santa Clara County ARES/RACES. All rights reserved. 7

---

---

---

---

---

---

---

---

---

---

7

### 2019 Training Schedule

Day	Date	Course	Instructor
Sat.	January 5	Field Ops Type III Part A	Fox
Sat.	February 9	Field Ops Type III Part B & Type II	Fox
Sat.	February 2	Net Control Type III Part A	Laubach
Sat.	March 2	Net Control Type III Part B	Laubach
Sat.	April 6	Net Control Type II	Laubach
Sat.	May 4	Message Passing	McKee
Sat.	June 1	Event Planning Type I	Howard
Sat.	July 13	Field Ops Type III Part A	Fox
Sat.	July 20	Field Ops Type III Part B & Type II	Fox
Sat.	August 3	Shadowing	Howard
Sat.	September 7	Packet Type III Part A	Oberhofer
Sat.	September 21	Cross Band Repeat / Antenna Fund.	Ott
Sat.	October 5	Packet Type III Part B	Oberhofer
Sat.	November 2	Packet Type II	Oberhofer
Sat.	November 16	Message Passing	McKee
Sat.	December 14	Year End Summary	County Staff

Copyright (C) 2018 Santa Clara County ARES/RACES. All rights reserved. 8

---

---

---

---

---

---

---

---

---

---

8

### 2019 Training Schedule

Day	Date	Course / Location	Instructor
Sat.	Feb. 9	Intro to EmComm (Cupertino)	Halchin
Sat.	Mar. 9	Fund. of EmComm (Cupertino)	Halchin
Wed.	June 14	Intro to EmComm (Sunnyvale)	Howard NIGHT CLASS
Wed.	July 12	Fund. of EmComm (Sunnyvale)	Howard NIGHT CLASS
Wed.	Oct. 9	Intro to EmComm (Mtn. View)	TBD NIGHT CLASS
Wed.	Nov. 13	Fund. of EmComm (Mtn. View)	TBD NIGHT CLASS

[www.scc-ares-races.org/training.html](http://www.scc-ares-races.org/training.html)

Copyright (C) 2018 Santa Clara County ARES/RACES. All rights reserved. 9

---

---

---

---

---

---

---

---

---

---

9

**Theory vs Practice**



- Learning is more than just attending a class
  - Focus of the classroom is on theory/procedures
  - Practice is hands on experimentation
- Just like lecture vs. lab in college, both are needed to learn the subject

**LECTURE LAB**

Copyright (C) 2018 Santa Clara County ARES/RACES. All rights reserved. 10

---

---

---

---

---

---

---

---

---

---

10

**On-Air Message Passing Practice**

- Use the time allocated to the Training Net
- Monthly on 3<sup>rd</sup> Tuesday
- Resource Net Repeaters will be linked  
AA6BT 146.115, N6NAC 444.625, W6ASH 440.800
- Initial session will be a demo
- Everyone encouraged to copy the messages (ICS-213)
- Future sessions will be more interactive with participants
- First one on Tuesday, December 18<sup>th</sup>, 8:30pm

Copyright (C) 2018 Santa Clara County ARES/RACES. All rights reserved. 11

---

---

---

---

---

---

---

---

---

---

11

Packet performance differences noted between weekly Mon. & Tues. practice sessions and performance at drills

**Pop-Up Packet Practice**

- Provide an opportunity to test equipment in a deployed environment
- Morning activity in probably a park
- Participation is quick and easy.
  - Travel to the pop-up packet location
  - Set up your station, send/receive a few messages (less than 1 hour)
  - Pack up your station
  - Be home for lunch
- No AC Power, No Generators. Should be able to run 1 hour on batteries.
- Mentors available to assist
- Saturday, April 13, 2019
- Opportunities for P3 & P2 evals and MAC Credit.

Copyright (C) 2018 Santa Clara County ARES/RACES. All rights reserved. 12

---

---

---

---

---

---

---

---

---

---

12

**Theory, Practice plus Experience**

- Theory and Practice get you most of the way
- You master the subject by getting experience

Copyright (C) 2018 Santa Clara County ARES/RACES. All rights reserved. 13

13

---

---

---

---

---

---

---

---

**2019 Activities**

Day	Date	Description	
Sat.	February 23	City/County Drill	10 am -12 pm
Sat.	April 13	Pop-Up Packet Practice	Morning
Sat.	May 18	City/County Drill	10 am -12 pm
Sat.	August 10	Radio Direction Finding Mini-Drill	Morning
Sat.	August 17	City/County Drill	10 am -12 pm
Sat.	TBD	Annual County Wide Exercise	All Day

Additional Public Service Events  
Additional events in your city

[www.scc-ares-races.org/activities/](http://www.scc-ares-races.org/activities/)

Copyright (C) 2018 Santa Clara County ARES/RACES. All rights reserved. 14

14

---

---

---

---

---

---

---

---

Copyright (C) 2018 Santa Clara County ARES/RACES. All rights reserved. 15

15

---

---

---

---

---

---

---

---



**2019 Changes to Field Ops Class**

- 2018 included more information, but too much for 3 hours
- 2019 splits the class into its original two parts
  - Field Operations Type III, Part A
  - Field Operations Type III, Part B and Type II
- More time for discussion, interaction, exercises

Copyright (C) 2018 Santa Clara County ARES/RACES. All rights reserved. 19

19

---

---

---

---

---

---

---

---



**Message Passing**  
2018 Year End Review, Update



Santa Clara County ARES®/RACES  
Don McKee, KE6DM  
Revised: 02-Dec-2018

ARES and Amateur Radio Emergency Service are registered servicemarks of the American Radio Relay League Incorporated and are used by permission. Copyright (C) 2018 Santa Clara County ARES/RACES. All rights reserved. 20

20

---

---

---

---

---

---

---

---

**What does it take to be a great Message Passer?**

- You need to be a great communicator,
  - com-mu-ni-cate: to transmit information, thought, or feeling so that it is satisfactorily received or understood
- Who is able to communicate *precisely*,
  - pre-cise-ly: 1. in a precise manner 2. exactly
- Using a shared, standard procedure, that EVERYONE is trained to use,

- While following instructions!

Copyright (C) 2018 Santa Clara County ARES/RACES. All rights reserved. 21

21

---

---

---

---

---

---

---

---

## Message Passing Fundamentals

The building blocks of the message passing process

Copyright (C) 2018 Santa Clara County ARES/RACES. All rights reserved. 22

22

---

---

---

---

---

---

---

---

---

---

## Follow the NTS Manual (plus SCCo changes)

- Most of what we will cover comes from the ARRL NTS manual
  - Chapter 2 – Sending Messages on Voice
  - Print it out; keep it in your go kit; refer to it often
  - Look for “[NTS-x.x.x]” section numbers
- A (very) few NTS procedures don’t fit RACES situation where the message author and recipient are not radio operators
  - Example: “X” for end of sentence
- Santa Clara County RACES additions and/or exceptions adjust for our environment (FM simplex or repeaters) and fill in missing procedures
  - Punctuation, symbols, GPS coords, ...

W3WP, vt-04-5101 FROM AAF-18 BYB 000-000000 ON VOICE P 2-1

CHAPTER 2 – SENDING MESSAGES ON VOICE

Table of contents (Double click RTT, click PDF page number to section, Click Home DOC)

2.0 CHAPTER 2 SENDING MESSAGES ON VOICE INTRODUCTION	4
2.1 PROCEDURES	4
2.1.1 PURPOSE	4
2.1.2 PURPOSE FOR INTERRUPTIONS	4
2.1.3 PROWORDS, OPERATIONAL WORDS	4
2.1.4 NUMBER BEFORE MESSAGE NUMBER (OR YES)	4
2.1.5 ENDING OF MESSAGE	4
2.1.6 PUNCTUATION	4
2.1.7 REPEAT	4
2.1.8 SPELL	4
2.1.9 SAY AGAIN (ONE TO) TO REPEAT FOR CLARITY	4
2.1.10 SAY AGAIN (ONE TO) TO CORRECT AN ERROR	4
2.1.11 SAY MORE (ONE MORE (1) MORE (2) OR MORE)	4
2.1.12 STOP	4
2.1.13 X	4
2.1.14 YES	4
2.1.15 AFFIRMATIVE, NEGATIVE, ROGER, Q SIGNALS	4
2.1.16 INTERCEPTOR'S WORDS FOR GROUPS	4
2.1.17 PREFIXES	4
2.1.18 TELEPHONE FIGURES	4
2.1.19 INITIALS (LETTER GROUP)	4
2.1.20 MIXED GROUP	4
2.1.21 MIXED GROUP PREFIXES	4
2.1.22 MIXED GROUP CALL	4
2.1.23 MIXED GROUP AND TEXT, IF NUMBERED DIAGRAMS	4
2.1.24 MIXED GROUP AND OTHER ADDRESSES	4
2.1.25 MIXED GROUP AND MESSAGE	4
2.1.26 MIXED GROUP AND LETTER	4
2.1.27 MIXED GROUP AND SPELLING	4
2.1.28 MIXED GROUP AND SPELLING CHOICES	4
2.1.29 MIXED GROUP AND WORDS	4
2.1.30 MIXED GROUP	4
2.1.31 MIXED GROUP	4
2.1.32 MIXED GROUP	4
2.1.33 MIXED GROUP	4
2.1.34 MIXED GROUP	4
2.1.35 MIXED GROUP	4
2.1.36 MIXED GROUP	4
2.1.37 MIXED GROUP	4
2.1.38 MIXED GROUP	4
2.1.39 MIXED GROUP	4
2.1.40 MIXED GROUP	4
2.1.41 MIXED GROUP	4
2.1.42 MIXED GROUP	4
2.1.43 MIXED GROUP	4
2.1.44 MIXED GROUP	4
2.1.45 MIXED GROUP	4
2.1.46 MIXED GROUP	4
2.1.47 MIXED GROUP	4
2.1.48 MIXED GROUP	4
2.1.49 MIXED GROUP	4
2.1.50 MIXED GROUP	4
2.1.51 MIXED GROUP	4
2.1.52 MIXED GROUP	4
2.1.53 MIXED GROUP	4
2.1.54 MIXED GROUP	4
2.1.55 MIXED GROUP	4
2.1.56 MIXED GROUP	4
2.1.57 MIXED GROUP	4
2.1.58 MIXED GROUP	4
2.1.59 MIXED GROUP	4
2.1.60 MIXED GROUP	4
2.1.61 MIXED GROUP	4
2.1.62 MIXED GROUP	4
2.1.63 MIXED GROUP	4
2.1.64 MIXED GROUP	4
2.1.65 MIXED GROUP	4
2.1.66 MIXED GROUP	4
2.1.67 MIXED GROUP	4
2.1.68 MIXED GROUP	4
2.1.69 MIXED GROUP	4
2.1.70 MIXED GROUP	4
2.1.71 MIXED GROUP	4
2.1.72 MIXED GROUP	4
2.1.73 MIXED GROUP	4
2.1.74 MIXED GROUP	4
2.1.75 MIXED GROUP	4
2.1.76 MIXED GROUP	4
2.1.77 MIXED GROUP	4
2.1.78 MIXED GROUP	4
2.1.79 MIXED GROUP	4
2.1.80 MIXED GROUP	4
2.1.81 MIXED GROUP	4
2.1.82 MIXED GROUP	4
2.1.83 MIXED GROUP	4
2.1.84 MIXED GROUP	4
2.1.85 MIXED GROUP	4
2.1.86 MIXED GROUP	4
2.1.87 MIXED GROUP	4
2.1.88 MIXED GROUP	4
2.1.89 MIXED GROUP	4
2.1.90 MIXED GROUP	4
2.1.91 MIXED GROUP	4
2.1.92 MIXED GROUP	4
2.1.93 MIXED GROUP	4
2.1.94 MIXED GROUP	4
2.1.95 MIXED GROUP	4
2.1.96 MIXED GROUP	4
2.1.97 MIXED GROUP	4
2.1.98 MIXED GROUP	4
2.1.99 MIXED GROUP	4
2.1.100 MIXED GROUP	4

Copyright (C) 2018 Santa Clara County ARES/RACES. All rights reserved. 23

23

---

---

---

---

---

---

---

---

---

---

## Intro Proword: Figure(s) [NTS-2.1.5.1]

- Identifies one or more numerals to follow
- Voice each digit separately
- A “.” is voiced “DECIMAL”
- A preceding “-” is voiced “MINUS”

Examples:

- Written: Send 12 dozen jelly donuts right away
- Spoken: “Send FIGURES ONE TWO <pause> dozen jelly donuts right away”
- Written: Switch to frequency 146.115
- Spoken: “Switch to frequency FIGURES ONE FOUR SIX DECIMAL ONE ONE FIVE”
- Written: The temperature will dip to -10
- Spoken: “The temperature will dip to FIGURES MINUS ONE ZERO”

Copyright (C) 2018 Santa Clara County ARES/RACES. All rights reserved. 24

24

---

---

---

---

---

---

---

---

---

---



**Intro Proword: Figure(s)** [NTS-2.1.5.1]

- Identifies one or more numerals to follow
- Voice each digit separately
- A "." is voiced "DECIMAL"
- A preceding "-" is voiced "MINUS"

Examples:

- Written: Send 12 dozen jelly donuts right away
- Spoken: "Send FIGURES ONE TWO <pause> dozen jelly donuts right away"
- Written: Switch to frequency 146.115
- Spoken: "Switch to frequency FIGURES ONE FOUR SIX DECIMAL ONE ONE FIVE"
- Written: The temperature will dip to -10
- Spoken: "The temperature will dip to FIGURES MINUS ONE ZERO"

Copyright (C) 2018 Santa Clara County ARES/RACES. All rights reserved. 25

---

---

---

---

---

---

---

---

---

---

25

**Punctuation**

- In SCCo RACES we handle punctuation differently than the ARRL NTS manual because the people creating and receiving the message are not other radio operators
- Period
  - Written: "." at the end of a sentence, is not written as a separate group.
  - Spoken: "period"
- Question Mark
  - Written: "?", commonly at the end of a sentence, is not written as a separate group.
  - Spoken: "question mark"
- Colon
  - Written: ":", often in an internet address, is not written as a separate group.
  - Spoken: "colon"
- Semicolon
  - Written: ";", within a sentence, is not written as a separate group.
  - Spoken: "semicolon"

Copyright (C) 2018 Santa Clara County ARES/RACES. All rights reserved. 26

---

---

---

---

---

---

---

---

---

---

26

**Symbols**

- The NTS manual does not cover how to voice many symbols. SCCo RACES will adopt the following standard:
- "/" is spoken "slash"
  - Example: "... and/or ..." is spoken "... mixed group alpha november delta SLASH oscar romeo ..."
- "\" is spoken "backslash"
  - Example: "... PasWd1 ..." is spoken "... mixed group uppercase papa lowercase alfa sierra uppercase whiskey BACKSLASH lowercase delta one ..."
- "+" is spoken "plus"
  - Example: "... +1-408-867-5309 ..." is spoken "... telephone figures PLUS one <pause> four zero eight <pause> eight six seven <pause> five three zero niner ..."
- "-" depends on the context
  - "-" is spoken "minus" as part of a number
    - Example: "... -123 ..." is spoken "... figures MINUS one two three ..."
  - "-" is spoken "dash" when used as a dash
    - Example: "... w2xsc-1 ..." is spoken "... mixed group whiskey two x-ray sierra charlie DASH one ..."

Copyright (C) 2018 Santa Clara County ARES/RACES. All rights reserved. 27

---

---

---

---

---

---

---

---

---

---

27

### Symbols (cont.)

- Voicing of “.” is context dependent:
  - At the end of a sentence, “.” is spoken “period”
    - Example: “... Bring food. ...”
    - Spoken: “... bring food PERIOD ...”
  - In a number, “.” is spoken “decimal”
    - Example: “... 146.475 ...”
    - Spoken: “... figures one four six DECIMAL four seven five ...”
  - In an email, packet, or internet address, “.” is spoken “dot”
    - Example: “... joe@host.com ...”
    - Spoken: “... email address juliet oscar echo atsign hotel oscar sierra tango DOT charlie oscar mike ...”

Copyright (C) 2018 Santa Clara County ARES/RACES. All rights reserved.

28

28

---

---

---

---

---

---

---

---

---

---

### Symbols (cont.)

- Here are some more:
  - “=” is spoken “equal”
    - Example: “... beds = 5; tarps = 10; ...”
    - Spoken: “... beds mixed group EQUAL figure 5 semicolon tarps mixed group EQUAL figures one zero semicolon ...”
  - “&” is spoken “ampersand”
    - Example: “... contact AT&T ...”
    - Spoken: “... contact mixed group alfa tango AMPERSAND tango ...”
    - Example: “... staging near Main & Park ...”
    - Spoken: “... staging near main mixed group AMPERSAND park ...”
  - “\_” is spoken “underscore”
    - Example: “... map\_201802.pdf ...”
    - Spoken: “... mixed group mike alfa papa UNDERSCORE two zero one eight zero two dot papa delta foxtrot ...”

Copyright (C) 2018 Santa Clara County ARES/RACES. All rights reserved.

29

29

---

---

---

---

---

---

---

---

---

---

### Message Passing Prowords

- Prowords are special words used to facilitate message passing by voice
- They are NOT written into the message
- Prowords can be grouped into four categories, depending on how they are used:
  - **Operational/Control Prowords**
    - Define the start, end, or control the flow of the message
  - **Clarification Prowords**
    - Always spoken after a group
    - Clarifies or emphasizes what was just said
  - **Qualification Prowords**
    - Used within a group
    - Defines a quality to allow precise copy
  - **Introductory Prowords**
    - Always spoken before a group
    - Alerts receiving operator to what is coming next
- It is important to use each of them in the right place to avoid confusing the recipient and slowing down the message transfer

Copyright (C) 2018 Santa Clara County ARES/RACES. All rights reserved.

30

30

---

---

---

---

---

---

---

---

---

---

### Qualification Prowords

- Always spoken WITHIN a group
  - Typically previously identified with an Introductory Proword
- Alerts the receiving operator to a special quality for the character(s) that follows
  - Allow precise copy, such as case-sensitive information (web addresses, passwords, chemical names, etc.)
- Implies that the following characters are going to be sent one character at a time, phonetically
- Remains in effect for group until over-ridden
  - Like the “Caps Lock” key on your keyboard

Copyright (C) 2018 Santa Clara County ARES/RACES. All rights reserved.

31

31

---

---

---

---

---

---

---

---

---

---

### Qualification Proword Examples

- “UPPERCASE” and “LOWERCASE”
  - Used to indicate that following characters should be copied in in the appropriate case
  - Used with ONE GROUP AT A TIME
  - Remain in effect until the end of the group or until over-ridden by another Qualification Proword (think “caps lock”)
  - Most of the time case doesn’t matter, but other times it’s critical (e.g. passwords, internet addresses)
- Examples:
  - Written: The password is passWORD
  - Spoken: “The password is password I spell LOWERCASE papa alfa sierra sierra UPPERCASE whiskey oscar romeo delta”
  - Written: Deliver 1 LiFePO4 battery
  - Spoken “deliver figure one mixed group UPPERCASE lima LOWERCASE india UPPERCASE foxtrot LOWERCASE echo UPPERCASE papa oscar four battery”

Copyright (C) 2018 Santa Clara County ARES/RACES. All rights reserved.

32

32

---

---

---

---

---

---

---

---

---

---

### Intro Proword: GPS Coordinates

- Identifies a set of GPS coordinates to follow
- Used when a set of numbers contain one or more of the coordinate “marker” symbols:
  - ° (degrees), ‘ (minutes), “ (seconds)
  - N (north), S (south), E (east), W (west)
- Voice the “marker” symbols where they appear
  - But don’t add them, if not already part of written message.
- **Include the word “AND” between the latitude and longitude parts.**
- Send as a single group, even if written across multiple “slots”
  - You may need to make adjustments to fit the “5 words at a time” rule
- If the numbers *look like* coordinates, but don’t contain any “marker” symbols, just send them as FIGURES.

Copyright (C) 2018 Santa Clara County ARES/RACES. All rights reserved.

33

33

---

---

---

---

---

---

---

---

---

---

### Intro Proword: GPS Coordinates (cont.)

- Examples:
  - Written: 41° 24.20', 2° 10.44'
  - Spoken: "GEE-PEE-ESS COORDINATES four one DEGREES <pause> two four decimal two zero MINUTES comma <pause> two DEGREES <pause> one zero decimal four four MINUTES"
  - Written: 41°24'12.2"N 2°10'26.5"E
  - Spoken: "GEE-PEE-ESS COORDINATES four one DEGREES <pause> two four MINUTES <pause> one two decimal two SECONDS NORTH <pause> two DEGREES <pause> one zero MINUTES <pause> two six decimal five SECONDS EAST"

Copyright (C) 2018 Santa Clara County ARES/RACES. All rights reserved.

34

34

---

---

---

---

---

---

---

---

---

---

### Intro Proword: Internet Address [NTS-2.2.4.6]

- Indicates an internet (e.g. "web") address follows
  - <scheme>://<hostname[:port]/<path>[?<query>]
    - https://www.google.com/
    - ftp://some.host.com:21/
    - http://qrz.com/The/Path/index.htm?name=Herman&call=W6XRL4
- Everything after <hostname> is case-sensitive!
- Example:
  - Written: http://www.scco.org/ops.html#GoKit
  - Spoken: "INTERNET ADDRESS hotel tango tango papa colon slash slash whiskey whiskey whiskey dot sierra charlie charlie oscar dot oscar romeo golf slash lowercase oscar papa sierra dot hotel tango mike lima poundsign uppercase golf lowercase oscar uppercase kilo lowercase india tango"

Copyright (C) 2018 Santa Clara County ARES/RACES. All rights reserved.

35

35

---

---

---

---

---

---

---

---

---

---

## Agency Forms and Informal Messages

Copyright (C) 2018 Santa Clara County ARES/RACES. All rights reserved.

36

36

---

---

---

---

---

---

---

---

---

---

**Critical Information to Capture ...**

As the operator passing the message, always include:

- Your message number
- Their message number
  - Log "N/A" if they don't have one
- Message handling order
  - Municipal Status default = Immediate
  - EOC-213RR default = Priority
  - Otherwise, default = Routine
- "To" Position & Location
  - Default = Planning
    - Includes Municipal Status and 213RR
- "From" Position & Location
- How message was transmitted
  - Sent vs. Received
  - Amateur Radio, Telephone, Packet, etc.
- Your name and FCC call sign
- Date and time message was transmitted

Other information should only be included if already on the form

- For example, message creation date/time, situation severity, reply actions, etc.
- Don't make stuff up!

Copyright (C) 2018 Santa Clara County ARES/RACES. All rights reserved. 37

37

---

---

---

---

---

---

---

---

---

---

---

---



**Net Control**  
2018 Year End Summary, Update



Santa Clara County ARES®/RACES  
Mark Laubach, K6FJC  
Revised: 05-Dec-2018

ARES and Amateur Radio Emergency Service are registered service marks of the American Radio Relay League Incorporated and are used by permission. Copyright (C) 2018 Santa Clara County ARES/RACES. All rights reserved. 38

38

---

---

---

---

---

---

---

---

---

---

---

---

**2018 Net Control Year End**

- No changes felt from California AB 1222 (aka AB 1785, Section 23123.5(f) CVC) and our mobile ham radio use
  - We will continue Travel Tracking Net and H&W checks as we modified from last year
  - <https://www.scc-ares-races.org/operations.html>
- Repeat focus request from 2017 year end: improve efficiency
  - Root cause ⇒ need better following of SCC message passing and use of prowords
    - Please study up – it does take practice
    - Our drills are "dress rehearsals" for the real thing, not the time to start practicing
  - NCO efficiency
    - Find ways to not repeat the same information
    - Remember to allow sufficient pauses, especially Resource Net Level 3 Travel Tracking

Copyright (C) 2018 Santa Clara County ARES/RACES. All rights reserved. 39

39

---

---

---

---

---

---

---

---

---

---

---

---

### Performance Standards and Best Practices

- Updates included:
  - Remove conflicting requirements on clothing
  - Updated procedure for switching nets
  - Requires ANSI Class 2 safety vest
  - Clarified Handling Order options
  - Maps (paper or offline)

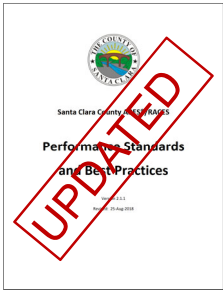

<http://www.scco-ares-races.org/operations.html>

Copyright (C) 2018 Santa Clara County ARES/RACES. All rights reserved.

40

---

---

---

---

---

---

---

---

---

---

### Mutual Aid Communicator Program

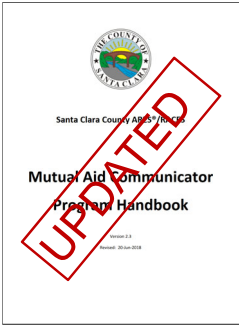

- Updates included:
  - N2, P2: higher power radio
  - F2, N2, S2: cross-band repeat
  - All Type 1: Event planning class
  - Loss/reinstatement process
  - NIMS credentialing

<http://www.scco-ares-races.org/operations.html>

Copyright (C) 2018 Santa Clara County ARES/RACES. All rights reserved.

41

---

---

---

---

---



---

---

---

---

---

## Packet Network Update

2018 Year End Review,  
2019 Update



Santa Clara County ARES®/RACES  
Jim Oberhofer  
Revised: 02-Dec-2018

ARES and Amateur Radio Emergency Service are registered trademarks of the National Radio Relay League, Incorporated and are used by permission.

42

---

---

---

---

---

---

---

---

---

---

**Packet Training  
Review**

Copyright (C) 2018 Santa Clara County  
ARES/RACES. All rights reserved. 43

43

---

---

---

---

---

---

---

---

**2018 Packet Classes**

**By the numbers**

- 318 classroom hours spent (not counting homework)
- 116 class sign-ups (all 3 classes)
- 106 class show-ups
  - 46 in Packet III-A
  - 35 in Packet III-B
  - 25 in Packet II
- 57 unique participants
- 24 packet Ops attended only one class
- 17 packet Ops attended only two classes
- 16 packet Ops attended all three classes

Copyright (C) 2018 Santa Clara County  
ARES/RACES. All rights reserved. 44

44

---

---

---

---

---

---

---

---

**Packet Exercise Workbook**

- Covered Packet III-B content
- Included related topics such as...
  - Checking out your packet station
  - Working with messages
  - Customizing message handling
  - And other topics, such as:
    - ICS 309 Reporting
    - Using Address Books
    - Message Addressing
- Watch for updates to the Exercise Workbook

Packet Exercise Workbook  
Santa Clara County RACES  
Version 1.1  
September 24, 2018

Copyright (C) 2018 Santa Clara County  
ARES/RACES. All rights reserved. 45

45

---

---

---

---

---

---

---

---

### Using Telnet Access for Outpost Training

- Required for Packet III-B and Packet II class \*if\* you have a Laptop but not a TNC & Radio.
- Full instructions on configuring Outpost to access the W5XSC Training BBS.

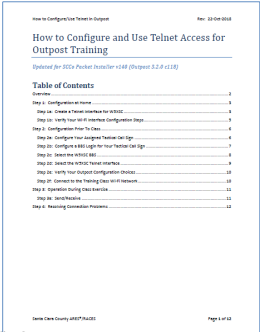

Copyright (C) 2018 Santa Clara County ARES/RACES. All rights reserved.

46

---

---

---

---

---

---

---

---

---

---

### Weekly Packet "Practice"

**By the Numbers (through 26-Nov)**

	Monday	Tuesday	Total
Total Practice Messages sent	821	1295	2116
% Practice Messages sent	38.8%	61.2%	100.0%
% Correct all the time	92.9%	93.5%	93.2%
Average # of Participants / Night	23	28	25.5

Copyright (C) 2018 Santa Clara County ARES/RACES. All rights reserved.

47

---

---

---

---

---

---

---

---

---

---

### Weekly Packet "Practice"

Q: When is a check-in not a check-in?  
 A: When it is "practice"

- See the "Standard Packet Check-In/Out Message" App Note under...  
<https://www.scc-ares-races.org/data/packet/index.html#app-notes>
- See the Practice Message, Subject section under...  
<https://www.scc-ares-races.org/data/packet/weekly-packet-practice.html#Message>

Copyright (C) 2018 Santa Clara County ARES/RACES. All rights reserved.

48

---

---

---

---

---

---

---

---

---

---



**Outpost & PacFORMS**  
Review

Copyright (C) 2018 Santa Clara County ARES/RACES. All rights reserved. 49

49

---

---

---

---

---

---

---

---

---

---

**SCCo Installer v140 – August 2018**

**By the numbers**

- 45 Total changes
- 26 SCCo Submitted
- 23 Enhancements
- 21 Defects

**These were related to**

- 13 - Message Handling
- 8 - PacFORMS
- 7 - Add-on related
- 3 - Send/Receive
- 2 - Subject Line related
- 2 - printer related
- ... plus another 10 changes

• See the details up on the SCCo RACES website...  
**Packet BBS Service > Presentations > 2018 > [SCCo Packet Installer v139 Summary](#)**

Copyright (C) 2018 Santa Clara County ARES/RACES. All rights reserved. 50

50

---

---

---

---

---

---

---

---

---

---

**New OA Municipal Status Form**

- Managing information in their terms
- New Operational Area Municipal Status Form replaces the City Scan form

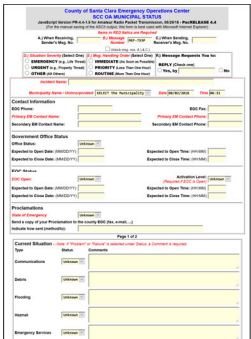

Copyright (C) 2018 Santa Clara County ARES/RACES. All rights reserved. 51

51

---

---

---

---

---

---

---

---

---

---



### First Add-on... *Alternate 911 (Alt911)*

- During the 2009 Morgan Hill cable cut, RACES responders staffed key city locations and the city's Dispatch Center (PSAP) to pass 9-1-1 assistance requests.
- Cupertino, Saratoga, and Los Altos Hills contract with Santa Clara County for all Sheriff, Fire, EMS, and dispatch services.
- In the event of a total telephone service outage, the public in these cities has no way to request 9-1-1 assistance.
- There is no local PSAP in Cupertino, Saratoga, or Los Altos Hills.
- We cannot easily pass 9-1-1 traffic because (i) our PSAP is located 15 miles away in San Jose, and (ii) DSW restrictions do not easily let us operate outside our city.

Copyright (C) 2018 Santa Clara County ARES/RACES. All rights reserved. 55

55

---

---

---

---

---

---

---

---

### First Add-on... *Alternate 911*

Copyright (C) 2018 Santa Clara County ARES/RACES. All rights reserved. 56

56

---

---

---

---

---

---

---

---

### Managing information in their terms

**What County Comm needs to know**

- **WHERE?** Where are you? Where is the incident?
- **WHAT?** What happened?
- **WHO?** Who's involved? Is anyone hurt?
- **WHEN?** When did it happen?  
Is it going on right now?
- **WHY?** Follow-up questions...

• Ref: <https://www.sccgov.org/sites/911/Pages/The-Five-Ws.aspx>

Copyright (C) 2018 Santa Clara County ARES/RACES. All rights reserved. 57

57

---

---

---

---

---

---

---

---

### County Comm's manual paper form

The form is a manual paper form for County Communications. It contains the following handwritten information:

- Type: STAVE
- Location: 2700 Carol Dr
- County Communications
- Beet Hildebrand
- 408,977 3200
- 60 yds mile left side rumness

Copyright (C) 2018 Santa Clara County ARES/RACES. All rights reserved.

58

58

---

---

---

---

---

---

---

---

---

---

### Alt911 Call Taking System

Ready	State	Event ID	Type	Issue	Location	City	Date / Time
Ready	CT0001374	FIRE	Transformer Fire	204 N. ...	Cupertino	03/01/18 03:19	
Ready	CT0001324	FIRE	House Fire	300 N. ...	Cupertino	03/04/18 10:19	
Ready	CT1451262	FIRE	House Fire	6900 West Maple Street	Cupertino	06/14/18 11:44	
Ready	WH1261302	FIRE	Fire	West Elm	Cupertino	08/21/18 14:02	
Ready	WH1261306	MED	Person Cant Get B...	124 East Main Street	Cupertino	09/13/18 19:58	
Ready	WH1261356	FIRE	House Fire	1287 Corner Street	Cupertino	09/13/18 20:15	

Copyright (C) 2018 Santa Clara County ARES/RACES. All rights reserved.

59

59

---

---

---

---

---

---

---

---

---

---

### Taking a MED report (dispatches EMS)

The screenshot shows the 'New Report' window in the Alt911 system. The 'What are you reporting?' field is set to 'Shortness Of Breath'. The 'MED' radio button is selected. The location is '2700 Stelling Road, Cupertino'. The 'Medical' section shows: Age: 78, Gender: Male, Consciousness: Yes, Breathing: Yes.

Copyright (C) 2018 Santa Clara County ARES/RACES. All rights reserved.

60

60

---

---

---

---

---

---

---

---

---

---

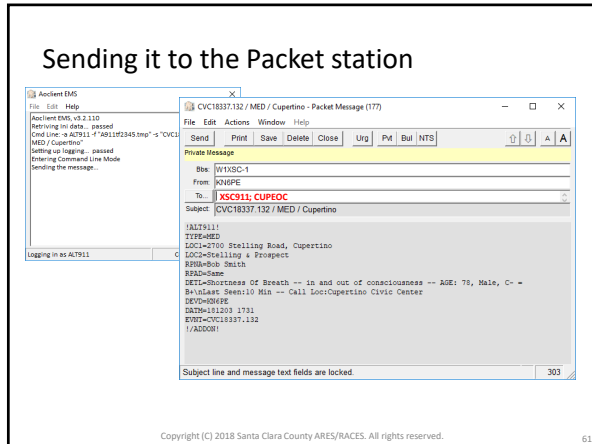

61

---

---

---

---

---

---

---

---

---

---

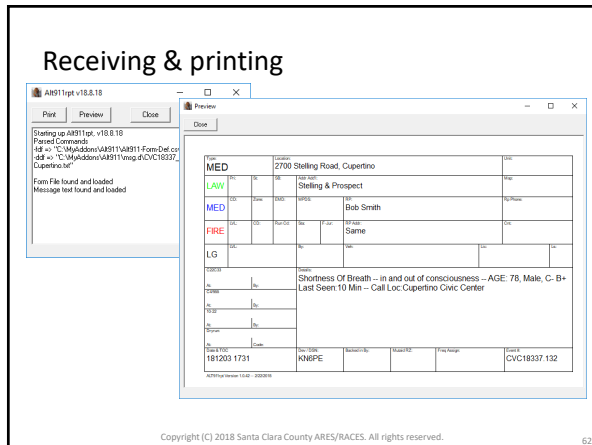

62

---

---

---

---

---

---

---

---

---

---

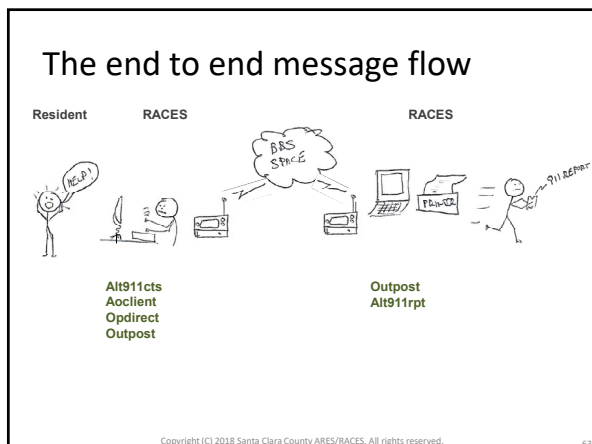

63

---

---

---

---

---

---

---

---

---

---

### The Packet Value Proposition

- What do these things have in common?
  - Outpost enhancements, updates
  - PacFORM additions, changes
  - Policy refinements
  - Messaging add-on delivery
- All of SCCo Packet Service improvements enhance our ability to support our Served Agencies.
- Our Served Agencies see our value as **doing business in their terms**, that is, managing information and communications on their behalf.
- Our packet infrastructure, training, and capabilities allow us to do this!

Copyright (C) 2018 Santa Clara County ARES/RACES. All rights reserved. 64

---

---

---

---

---

---

---

---

---

---

64

### For More Information

- Support
  - See the Santa Clara County ARES/RACES web site packet page
    - <https://www.scc-ares-races.org/data/packet/index.html>
  - Join the packet discussion group
- Practice
  - Send a message during the weekly packet net, either or both days
    - <https://www.scc-ares-races.org/data/packet/weekly-packet-practice.html>
    - Automated feedback to help you improve, verify you've got it right
  - Participate as a packet operator at drills and other events

Copyright (C) 2018 Santa Clara County ARES/RACES. All rights reserved. 65

---

---

---

---

---

---



---

---

---

---

65

## County Wide Drill Moffett Field



Santa Clara County ARES®/RACES  
Andreas Ott, K6OTT  
Revised: 05-Dec-2018

ARES and Amateur Radio Emergency Service are registered service marks of the American Radio Relay League Incorporated and are used by permission.  
Copyright (C) 2018 Santa Clara County ARES/RACES. All rights reserved. 66

---

---

---

---

---

---

---

---

---

---

66

**XSC-18-08T**  
**aka. #CWD20181027**  
**Moffett Field**  
 ARRL Simulated Emergency Test 2018  
 Supporting Santa Clara County CERT  
 teams communications at six field  
 locations and an EOC

KB0TF

Copyright (C) 2018 Santa Clara County ARES/RACES. All rights reserved.

67

67

---

---

---

---

---

---

---

---

**Stats (some preliminary)**

- 60 participants: 41 ham radio operators (17 “new hams” licensed since 2014), 1CERT, 18 staff
- MAC evaluations at levels 3, 2 and 1
- 2 operations shifts, 3.25 hours each
- 16 cities and agencies represented
- 6 simulated command posts, 1 EOC in Drill City
- 78 messages passed: 43 packet, 35 voice (some logs are most likely missing)
- ARRL SET score: 579 points

Copyright (C) 2018 Santa Clara County ARES/RACES. All rights reserved.

68

68

---

---

---

---

---

---

---

---

**EOC**



Copyright (C) 2018 Santa Clara County ARES/RACES. All rights reserved.

69

69

---

---

---

---

---

---

---

---

### Field Command Post



Copyright (C) 2018 Santa Clara County ARES/RACES. All rights reserved.

70

70

---

---

---

---

---

---

---

---

---

---

### Lessons learned (what staff is doing)

- This is as close to a real incident as it gets (supporting CERT in the field to communicate to the EOC)
- Repeat experience (same drill held in 2016), still very labor intensive in planning and execution
- You wish you had a working printer at your field packet station
- DSW processing (thank you for your patience)
- Processes, procedures, content of training classes
- Forms review on-site at checkout (and trying to “recreate” the event from incomplete logs)

Copyright (C) 2018 Santa Clara County ARES/RACES. All rights reserved.

71

71

---

---

---

---

---

---

---

---

---

---



## SCCo ARES/RACES Data Network Update



Santa Clara County ARES®/RACES  
Michael E Fox, N6MEF  
Revised: 05-Dec-2018

ARES and Amateur Radio Emergency Service are registered service marks of the American Radio Relay League Incorporated and are used by permission.

Copyright (C) 2018 Santa Clara County ARES/RACES. All rights reserved.

72

72

---

---

---

---

---

---

---

---

---

---



### Agenda

- Infrastructure
  - Plain Text Conversion for E-mail to Packet
  - Redundant Core Connectivity
  - Power System Enhancements
- Access
  - 440 MHz TCP/IP Radios
  - WiFi Connections to Cities, Hospitals, ...

Copyright (C) 2018 Santa Clara County ARES/RACES. All rights reserved.

73

---

---

---

---

---

---

---

---

---

---

### Reminder: Plain Text Conversion for E-mail to Packet

Original E-Mail      Packet: Old Behavior      Packet: New Behavior

**Result:** Shorter, readable, printable, recipient informed of changes

Copyright (C) 2018 Santa Clara County ARES/RACES. All rights reserved.

74

---

---

---

---

---

---

---

---

---

---

### Plain Text Conversion: Status

- 2017 Year End
  - Basic functionality working on development server
  - Need to add
    - Error-handling
    - Variety of unusual cases: ex. encoding, blank body w/ text attachment
  - Lots more testing needed; move to test server
  - Expected production deployment: Spring 2018
- 2018 Year End
  - No additional progress – other priorities
  - Plan: Deliver basic functionality for early 2018; complex cases later

Copyright (C) 2018 Santa Clara County ARES/RACES. All rights reserved.

75

---

---

---

---

---

---

---

---

---

---

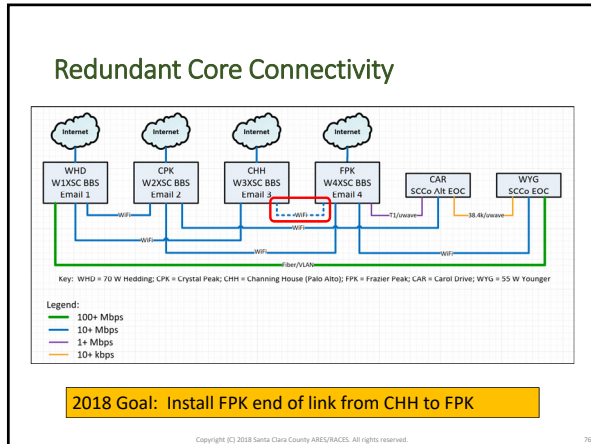

76

---

---

---

---

---

---

---

---

---

---

---

---

### Redundant Core Connectivity: Status

- 2018 Progress
  - Administrative challenges overcome
  - Dish mounted at Frazier Peak
- Next steps
  - Complete wiring at Frazier Peak
  - Antenna alignment (both ends)
- Challenges
  - Rainy season

77

---

---

---

---

---

---

---

---

---

---

---

---

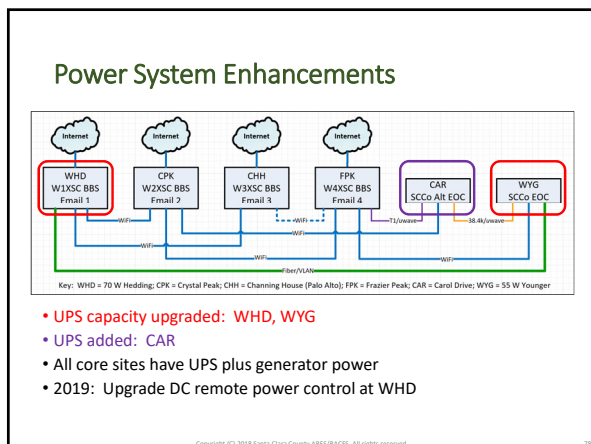

78

---

---

---

---

---

---

---

---

---

---

---

---



### 440 MHz TCP/IP Radios: 2019 Plan

- We know this works
  - Both vendors have large commercial deployments
  - But they are in licensed bands with directional antennas
- Radios are too expensive and proprietary to move forward before we achieve success in a reasonable number of locations
- Follow-up with vendor, implement recommendations, make it work in our environment
- Once we know what it takes to make it work, re-evaluate cost of overall solution

Copyright (C) 2018 Santa Clara County ARES/RACES. All rights reserved.

82

---

---

---

---

---

---

---

---

### WiFi Connections to Cities, Hospitals, ...

- We're ready for subscriber connections
- Service description web pages exist
  - Explains what's possible, how to request connection
- Subscriber config web page by end of the month
  - Should answer most (all?) questions about subscriber-side network configuration: addressing, routing, firewalling, etc.
- 2019 Plans
  - Acceptable use policy
  - Self-service login/password management
  - Connecting sites

Copyright (C) 2018 Santa Clara County ARES/RACES. All rights reserved.

83

---

---

---



---

---

---

---

---

## Amateur Radio for Emergency Managers



Santa Clara County ARES®/RACES/ACS  
Michael Fox, N6MEF  
Revised: 05-Dec-2018

ARES and Amateur Radio Emergency Service are registered service marks of the American Radio Relay League Incorporated and are used by permission.  
Copyright (C) 2018 Santa Clara County ARES/RACES. All rights reserved.

84

---

---

---

---

---

---

---

---

This section to be distributed later

Copyright (C) 2018 Santa Clara County ARES/RACES. All rights reserved.

85

---

---

---

---

---

---

---

---

End

Thanks for coming!

Please complete the course Evaluation.  
See you at a training class next year!

Copyright (C) 2018 Santa Clara County ARES/RACES. All rights reserved.

86

---

---

---

---

---

---

---

---