

Packet Type III Part A



Santa Clara County ARES®/RACES/ACS

Last Updated: 29 July 2024

ARES and Amateur Radio Emergency Service are registered service marks of the American Radio Relay League Incorporated and are used by permission.

© Copyright 2011-2024 Santa Clara County ARES®/RACES. All rights reserved. 1

USE AND DISTRIBUTION NOTICE

Santa Clara County RACES authorization is granted to use and duplicate this material as-is as long as this page and the copyright notices on each page are included, acknowledging Santa Clara County ARES/RACES as the holder of the copyright.

Permission is granted to adapt this presentation to your needs as long as you acknowledge our copyright and include a note similar to "adapted with permission from Santa Clara County ARES/RACES"

For additional information on training or any of our programs send an email to: info@scc-ares-races.org

© Copyright 2011-2024 Santa Clara County ARES®/RACES. All rights reserved. 2

Housekeeping

- Introductions
- Pen/pencil & paper
- Cell phones on silent or vibrate
- Side conversations
- Questions
- Breaks (code: 9033)
- Restrooms
- In case of emergency
- No wandering or exploring other areas of the building.

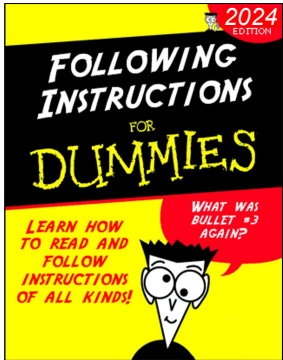

Copyright (C) 2024 Santa Clara County ARES/RACES. All rights reserved.

1. OVERVIEW

© Copyright 2011-2024 Santa Clara County ARES®/RACES. All rights reserved.

Overview: Packet Classes

Packet Type III, Part A

- Packet Operator Credentials
- Packet Network Overview
- Packet Network Components
- Packet Station HW & SW
- Accessing the Network
- Standard Workflow

Packet Type III, Part A+

- Packet Operations Self-Paced Exercise workbook

Packet Type III, Part B

- Packet Operations
- Diagnosing Setup Problems
- Selecting a BBS
- Creating Messages
- Event Documentation
- Productivity Hints
- Exercises

Packet Type II: Advanced Techniques, such as County EOC Packet Station Setup & Operations, Operating without Outpost.

© Copyright 2011-2024 Santa Clara County ARES/RACES. All rights reserved.

5

Learning Objectives

At the end of this class, you should be able to:

- Describe the purpose and use of packet communications
- Describe the Santa Clara County BBS network
- Describe the components of the baseline packet station
- Describe the Outpost and PackItForms software and their basic use

© Copyright 2011-2024 Santa Clara County ARES/RACES. All rights reserved.

6

Agenda

- Packet Operator Credentials
- Packet Network Overview
 - What is packet? Why do we use it?
- Packet Network Components
 - SCCo BBSs, other networks, antennas, radios, TNCs, PCs, printers
- Baseline Packet Station: hardware & software
- Accessing the Network
- Standard Workflow
- Homework Intro

© Copyright 2011-2024 Santa Clara County ARES/RACES. All rights reserved.

7

P3

P2

P1

2. PACKET OPERATOR CREDENTIALS

© Copyright 2011-2024 Santa Clara County ARES/RACES. All rights reserved.

8

Packet Operator Type III

P3

- Capabilities and services offered
 - Fully independent operator
 - Set-up an existing, pre-installed packet system that is currently disconnected and stored
 - Turn everything on and verify connectivity
 - Operate a PC that has Outpost and PackItForms already pre-installed
 - Configure Outpost options to the county standard
 - Operate a packet station to send, receive, print, log and track packet messages
 - Send 7 standard PackItForm messages (Check-In/Out message, ICS 213 Message, ICS 213RR Resource Request, OA Jurisdiction Status, Shelter Status, Allied Health Status, RACES Mutual Aid Request)

© Copyright 2011-2024 Santa Clara County ARES/RACES. All rights reserved.

9

Packet Operator Type III



P3

- Typical Assignments
 - Locations with low-to-medium traffic and a pre-installed packet station
 - Small city EOC
 - Small staging area
 - Small aid station
 - Shelter
 - Health facility
 - Point of Distribution/Dispensing site

© Copyright 2011-2024 Santa Clara County ARES/RACES. All rights reserved.

10

Packet Operator Type II, Type I

- Packet Operator Type II = Advanced Operator 
 - Perform the tasks of a Packet Operator III
 - Equipped with a complete packet station
 - Able to install Outpost and PackItForms
 - Able to send messages, including PackItForms without Outpost
 - Medium to high traffic conditions
- Packet Operator Type I = Specialist Operator 
 - Capable of the most complicated, highest traffic levels
 - Capable of designing, deploying, operating and coordinating complex multi-radio, multi-band, multi-node packet networks for larger events or incidents
 - Set-up, manage, and troubleshoot a packet BBS
 - Equipped for and capable for out-of-county and extended deployments

© Copyright 2011-2024 Santa Clara County ARES/RACES. All rights reserved.

11

For more information...

Credentialing Program

- Program Information
<https://www.scc-ares-races.org/credentials>
- Discussion group
<https://www.scc-ares-races.org/discuss-groups.html>

© Copyright 2011-2024 Santa Clara County ARES/RACES. All rights reserved.

12

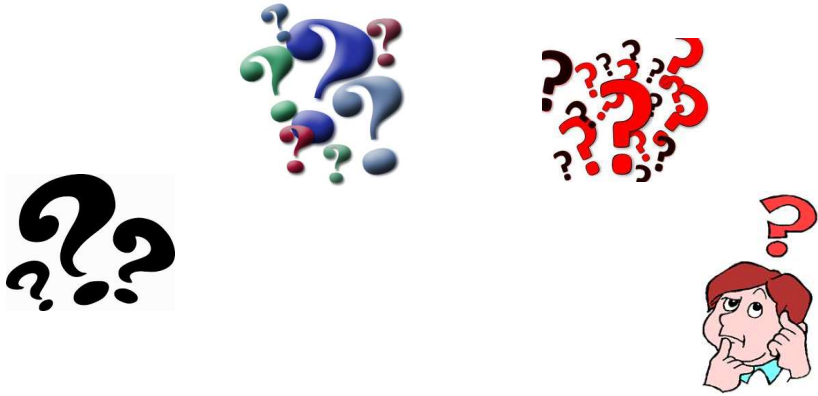

What is packet radio? Why do we use it?

3. PACKET RADIO OVERVIEW

© Copyright 2011-2024 Santa Clara County ARES/RACES. All rights reserved.

13

What is Packet Radio?

- One of many digital modes available in Amateur Radio
- Transmitted information is error free!
- AX.25; based on the X.25 protocol, with Amateur Radio features
- Sends a “packet” of data at a time: envelope + payload
 - Differs from character-at-a-time modes (PSK31 or RTTY)
 - Envelope contains header at beginning & checksum at end

Header	Payload	CHK
--------	---------	-----

- Header contains addressing information (to, from)
- Payload contains the data to be sent
- Checksum used to determine if packet was received error-free... the error check

- Typically operates at 1200, 9600 baud on VHF & UHF and 300 baud on HF

© Copyright 2011-2024 Santa Clara County ARES/RACES. All rights reserved.

14

Why Packet Radio?



- It's fast
 - When there is no Internet, it's fast!
 - ~15 times faster than voice
 - 80+ messages sent/received, logged, acknowledged, printed in triplicate, perfectly legible, in < 2 hrs, with 0 errors, by 1 person!
- It's easy
 - Hardware: pre-built cables; straight-forward connections
 - Software: if you can use e-mail, you can use Outpost
if you can use a browser, you can use PackItForms
 - Procedures: extensive documentation on the website
- It's deployable
 - Virtually anywhere in the county and most of surrounding counties
- It fits our served agencies' needs and workflow
 - Preferable for long, complex, and/or high-volume messages; forms; message numbering; explicit acknowledgments, logging, tracking

© Copyright 2011-2024 Santa Clara County ARES/RACES. All rights reserved.

15

Why Use Packet Radio?

- Packet is ideal for passing complex messages
 - Lists of information
 - Tabular data
 - Addresses
 - Instructions
 - Complex words
“turboencabulator”, “thymidylate synthase”
- Messages are transmitted accurately
 - Originator can verify the contents before it is sent
 - Reduces transcription errors
- Messages are transmitted quickly
 - Keeps the voice channel clear

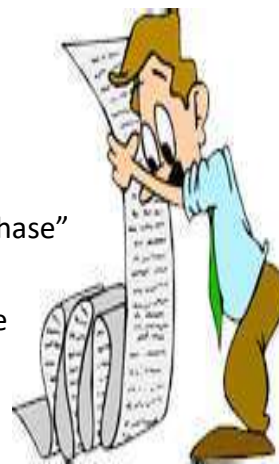

© Copyright 2011-2024 Santa Clara County ARES/RACES. All rights reserved.

16

Typical Message Content

- Unstructured Text (informal message)
 - Check-ins, and -outs
 - Health and Welfare
 - Simple text messages
- Forms
 - Status
 - Resources
 - ICS 213
 - Others.....
- Structured Text
 - Lists
 - Addresses
 - Tables



© Copyright 2011-2024 Santa Clara County ARES/RACES. All rights reserved.

17

Typical Message Flows

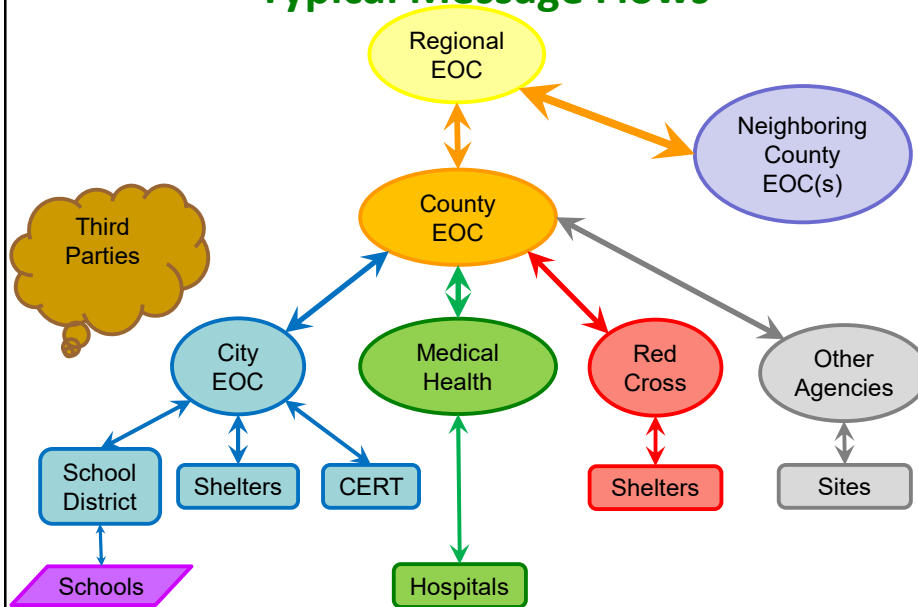

© Copyright 2011-2024 Santa Clara County ARES/RACES. All rights reserved.

18

What Can We Connect To?

- A packet radio station can connect to a variety of other station types

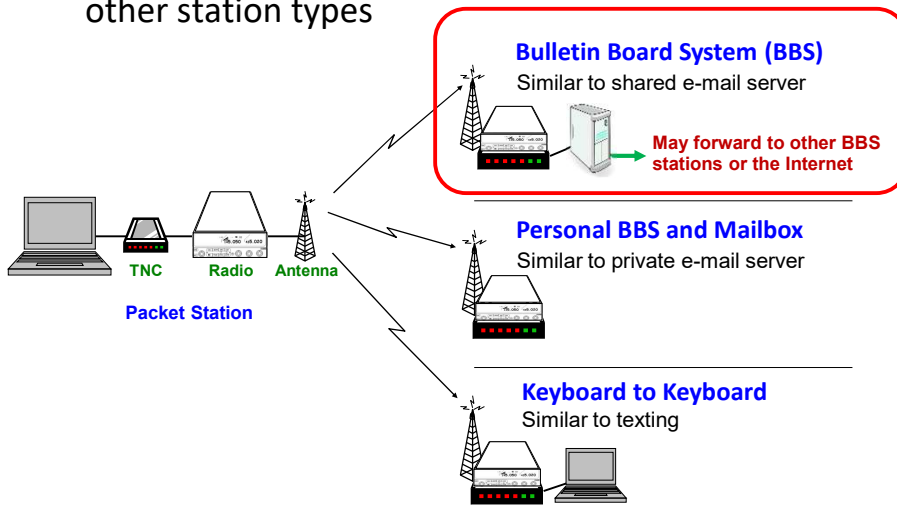

© Copyright 2011-2024 Santa Clara County ARES/RACES. All rights reserved.

19



High level overview

4. PACKET NETWORK COMPONENTS

© Copyright 2011-2024 Santa Clara County ARES/RACES. All rights reserved.

20

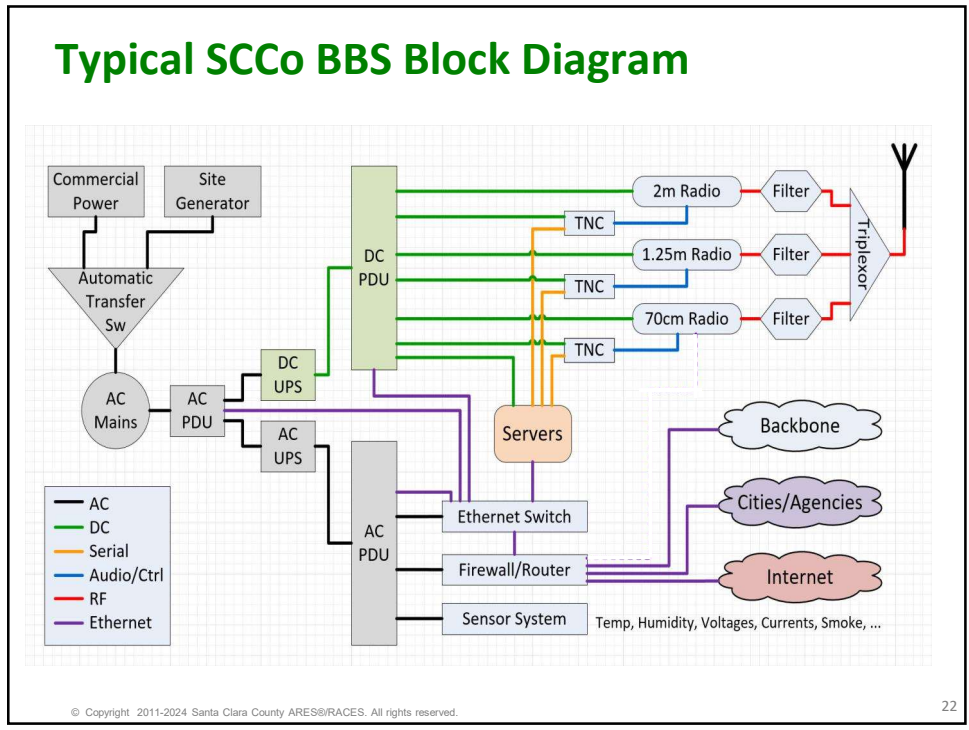
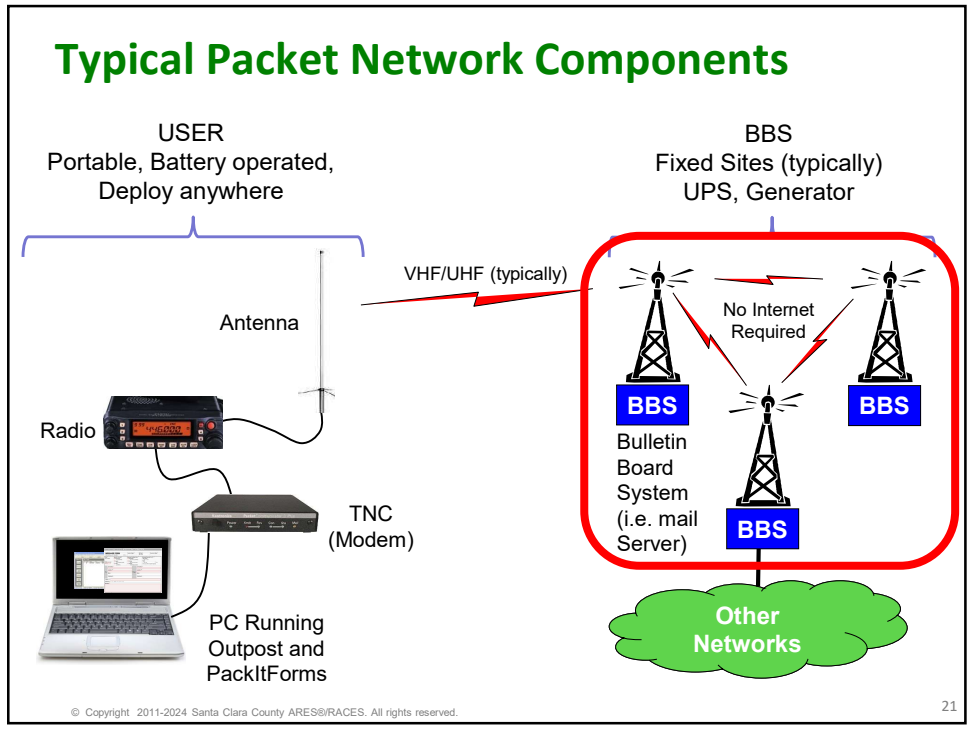

Typical SCo BBS Installation



- ← Cavity Filters
- ← Sensor System
- ← KB/Mouse/Display
- ← Routers
- ← Ethernet Switch
- ← Firewall
- ← Wi-Fi PoE
- ← Server(s)
- ← Radios
- ← Power Dist/Control
- ← AC & DC UPS
- ← All strapped or bolted down



Commercial installation standards, shielding, frequency coordination



No moving parts (fanless)
Mirrored SSD storage
Commercial temp range (120F)

© Copyright 2011-2024 Santa Clara County ARES/RACES. All rights reserved.

23

Typical Sensors and Alarms

Summary					
Internal Sensors					
No.	Description	Type	Value	Status	Action
1	Internal Temperature	Temperature	81.5°F	Normal	View Edit
2	Internal Humidity	Humidity	25%	Normal	View Edit
3	Input Voltage	Voltage	13.6V	Normal	View Edit

Sensors					
Conn.	Description	Type	Value	Status	Action
1	Thermostat Temp (TH1)	Temperature Combo	76.4°F	Normal	View Edit Delete
1	Thermostat Humidity (TH1)	Humidity Combo	26%	Normal	View Edit Delete
2	Room Temp (TH2)	Temperature Combo	80.1°F	Normal	View Edit Delete
2	Room Humidity (TH2)	Humidity Combo	23%	Normal	View Edit Delete
3	Cabinet Temp (TH3)	Temperature Combo	80.3°F	Normal	View Edit Delete
3	Cabinet Humidity (TH3)	Humidity Combo	25%	Normal	View Edit Delete
5	Mains AC Vols (ACL1)	ACLM-V AC Voltage	120.6V	Normal	View Edit Delete
5	Mains AC Freq (ACL1)	Frequency	60.1Hz	Normal	View Edit Delete
5	Inverter AC Vols (ACL2)	ACLM-V AC Voltage	123.4V	Normal	View Edit Delete
5	Inverter AC Freq (ACL2)	Frequency	60.1Hz	Normal	View Edit Delete
9	DC UPS Batt1 Vols (DC1.1)	Voltage	13.6V	Normal	View Edit Delete
9	DC UPS Batt2 Vols (DC1.2)	Voltage	13.6V	Normal	View Edit Delete
10	AC UPS Batt1 Vols (DC2.1)	Voltage	13.6V	Normal	View Edit Delete
10	AC UPS Batt2 Vols (DC2.2)	Voltage	13.6V	Normal	View Edit Delete
11	DC UPS Load Vols (DC3)	Voltage	13.6V	Normal	View Edit Delete
11	AC UPS Load Vols (DC4)	Voltage	13.6V	Normal	View Edit Delete

Digital Inputs	
Conn.	Description
8	Smoke

IP Devices	
No.	Description
1	MEF-Primary-WAN-IP
2	WXSC-GW
3	WXSC-GW
4	CHK-FPK-B1
5	WHO-CHK-R2

- Environmental
 - Temp, humidity, voltage, current, smoke, ...
- Operational
 - Backbone links, critical systems, storage, gateway functions, forwarding, ...

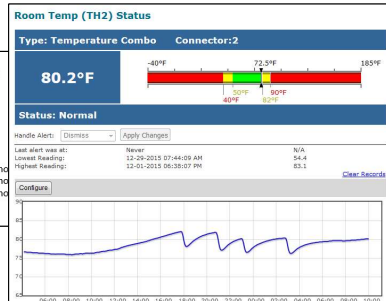

24

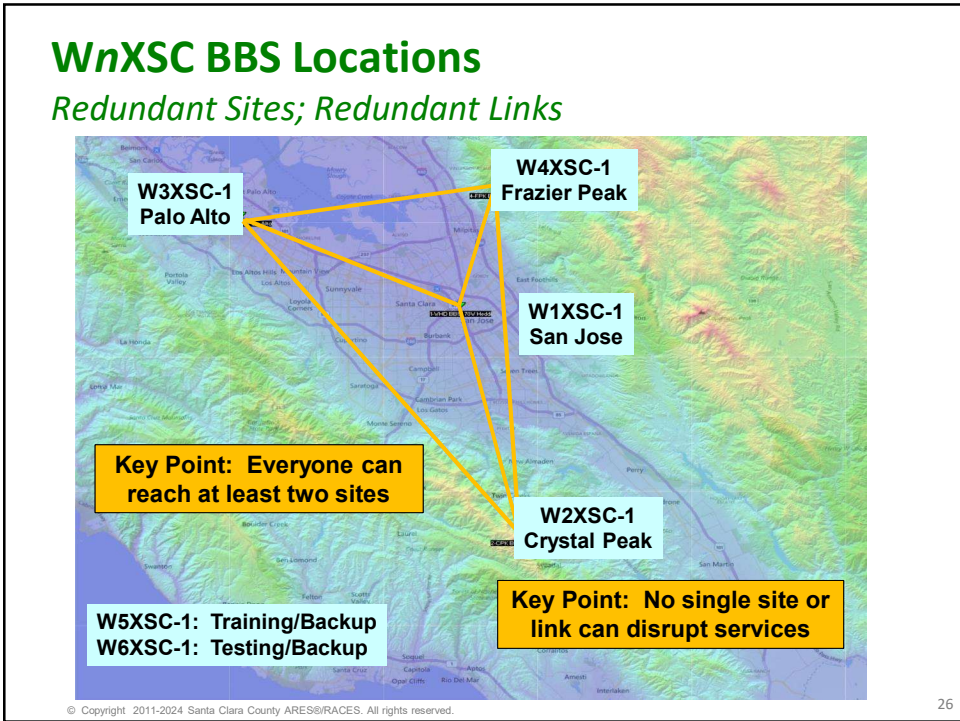
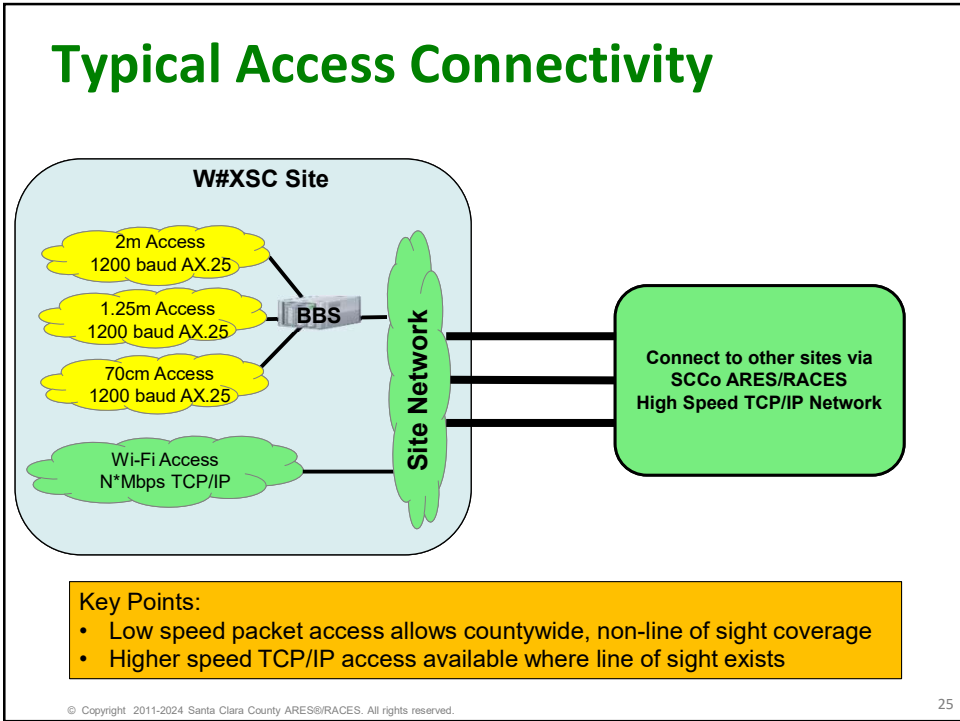

Which BBS Should I Use?

- Every city/agency has a primary and secondary BBS
 - Based on RF coverage and user load
 - All users in that city/agency should use those BBS's
- Use the primary BBS whenever possible
- If the primary is not available, use the secondary
- If the primary and secondary are not available, use whatever you can reach

© Copyright 2011-2024 Santa Clara County ARES/RACES. All rights reserved.

27

Coverage Maps Available On The Web

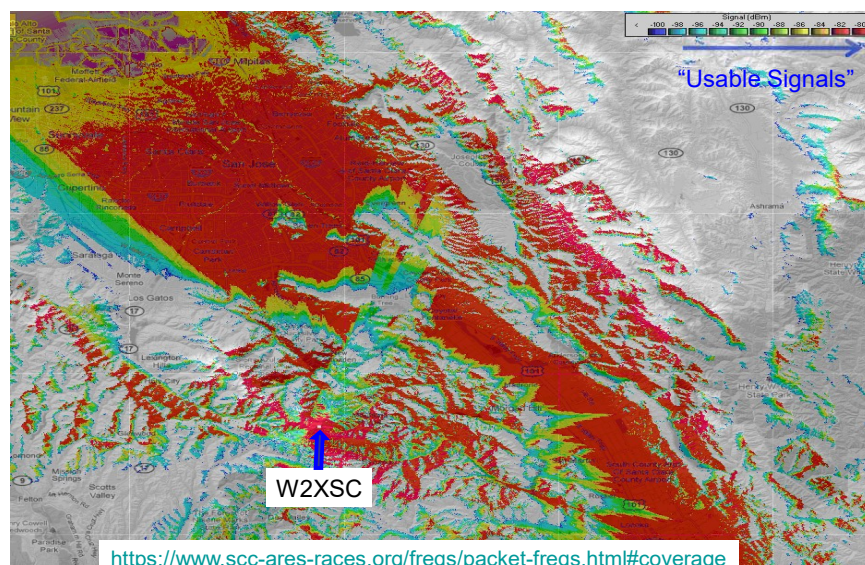

© Copyright 2011-2024 Santa Clara County ARES/RACES. All rights reserved.

28

Primary & Secondary BBSs

- Primary and Secondary BBSs are listed on the website

#	Agency	Prefix	Primary BBS	Secondary BBS
Santa Clara County Cities and Agencies				
1	American Red Cross	ARC	W1XSC	W4XSC
2	CAL FIRE VIPs - Santa Clara Unit	SCU	W2XSC	W1XSC
3	Campbell, City of	CBL	W1XSC	W4XSC
4	Cupertino, City of	CUP	W1XSC	W4XSC
5	Gilroy, City of	GIL	W2XSC	W1XSC
6	Hospitals (all SCCo) & DEOC	HOS	W2XSC	W1XSC
7	Loma Prieta Region	LMP	W2XSC	W1XSC
8	Los Altos, City of	LOS	W3XSC	W1XSC
9	Los Altos Hills, Town of	LAH	W3XSC	W1XSC

<https://www.scc-ares-races.org/freqs/packet-freqs.html>

© Copyright 2011-2024 Santa Clara County ARES/RACES. All rights reserved.

29

BBS Call Signs and Frequencies

- BBS access frequencies are also listed on the website

Call Sign	AX.25	User Access	BBS-BBS	Location
W1XSC	W1XSC-1	145.750, 223.620, 433.570		Santa Clara Co Office Bldg (San Jose)
W2XSC	W2XSC-1	145.730, 223.560, 433.590		Crystal Peak (South County)
W3XSC	W3XSC-1	144.310, 223.540, 433.450		Palo Alto
W4XSC	W4XSC-1	145.690, 223.600*, 433.550	223.600	Frazier Peak (above Milpitas)
W5XSC	W5XSC-1	varies	varies	Training, events, backup
W6XSC	W6XSC-1	varies	varies	Testing, backup

- Recommendation
 - Individuals use 2m or 440 access (more readily available equipment)
 - EOCs use 220 access (less congested)
 - Download and print this listing for your Go Kit
 - Check web site and bulletins for changes

© Copyright 2011-2024 Santa Clara County ARES/RACES. All rights reserved.

30

BBS information on packet

What if the web site is not available?

- The same information is also posted in a notice on all BBSs
 - Currently located in the “xscperm” area.
- Keep a copy in your Outpost “Archive” folder or create a “XSC Notices” folder
- Post it at your EOC or packet operating position

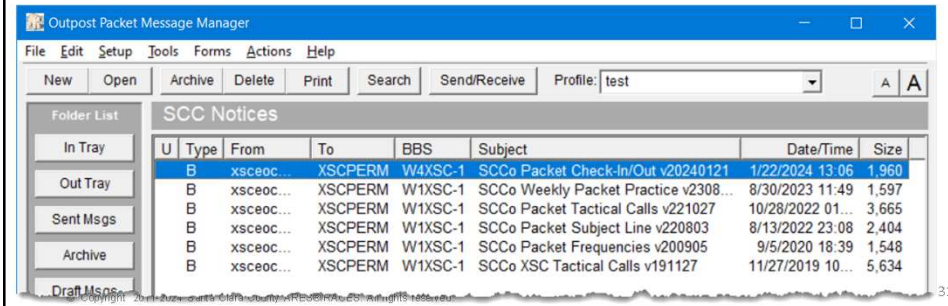

Typical Packet Network Components

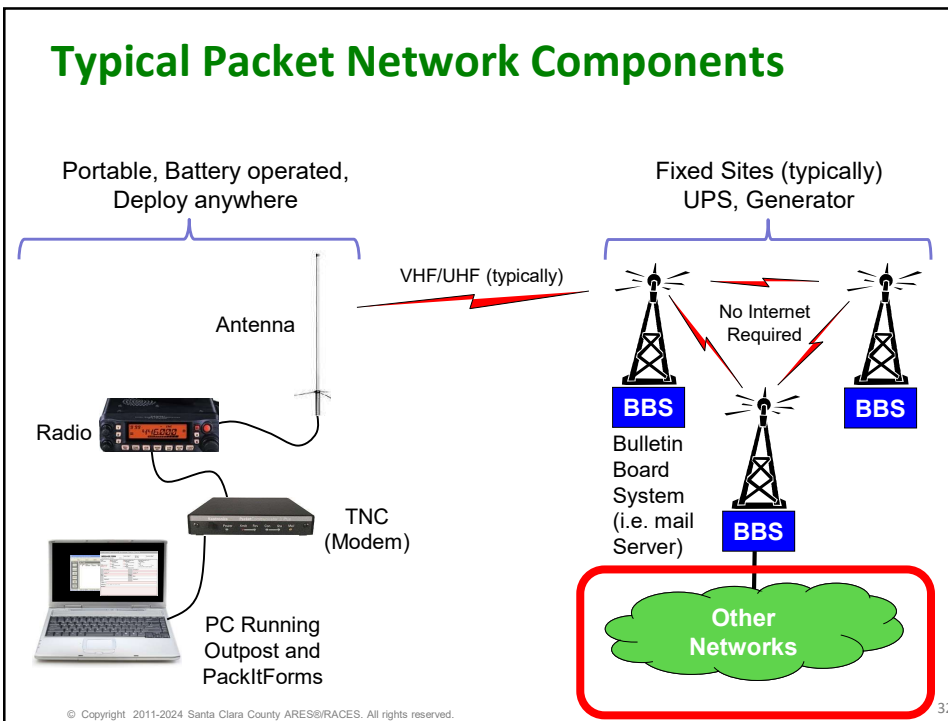

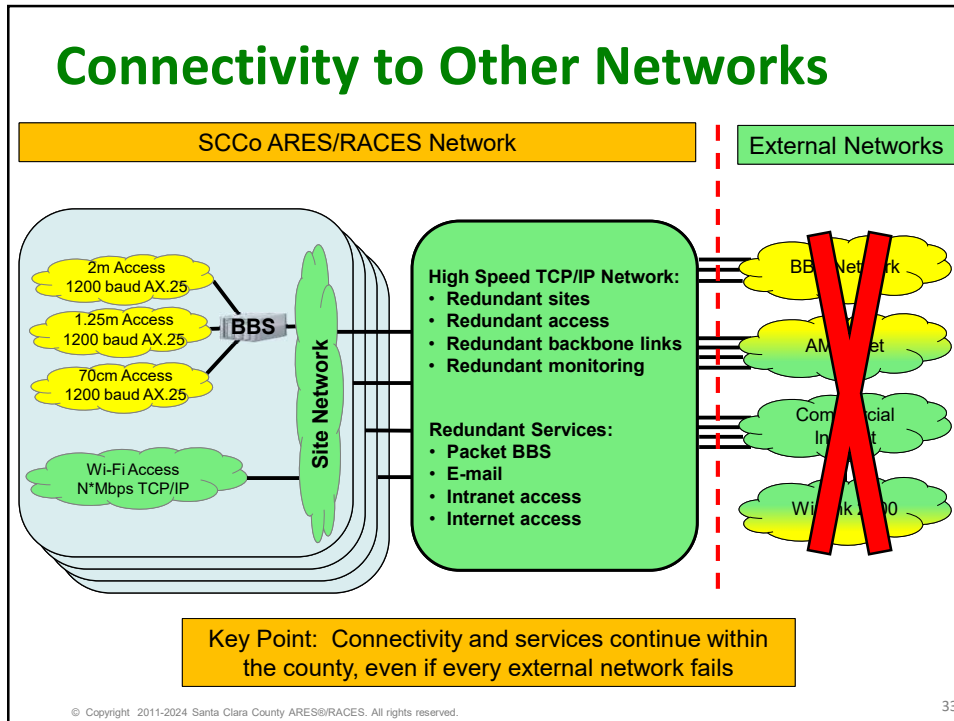

“When All Else Fails”

- 2016 Loma Fire
- Failure on top of failure
 - Commercial power failed
 - Generator at radio site failed
 - Roads closed; no access to site to bring backup generator
 - Internet service provider networks failed
 - Most private communications systems failed
- Santa Clara County ARES/RACES network continued to run
 - Provided temp, humidity, smoke sensor info to other site tenants
 - Used to send/receive Internet email while ISP networks were down

Crystal Peak – North Tower

Source: NBC

© Copyright 2011-2024 Santa Clara County ARES@RACES. All rights reserved. 34

Designed for harsh conditions



- January 2020: winter conditions on Crystal Peak (3600 ft ASL)... about 6 to 8 inches of snow
- Some sites experience high winds (100+ MPH), freezing conditions (including snow and ice), high temperatures (when A/C fails), power outages, or worse
- Conditions may make sites inaccessible for days or even weeks.
- Regardless of the situation, the network has to keep running or it won't be useful in an emergency
- This influences everything we do:
 - Station design (redundancy), equipment selection
 - Hardware installation standards, software configuration practices
 - Monitoring and alarms

© Copyright 2011-2024 Santa Clara County ARES/RACES. All rights reserved.

5. More Packet Network Components

© Copyright 2011-2024 Santa Clara County ARES/RACES. All rights reserved.

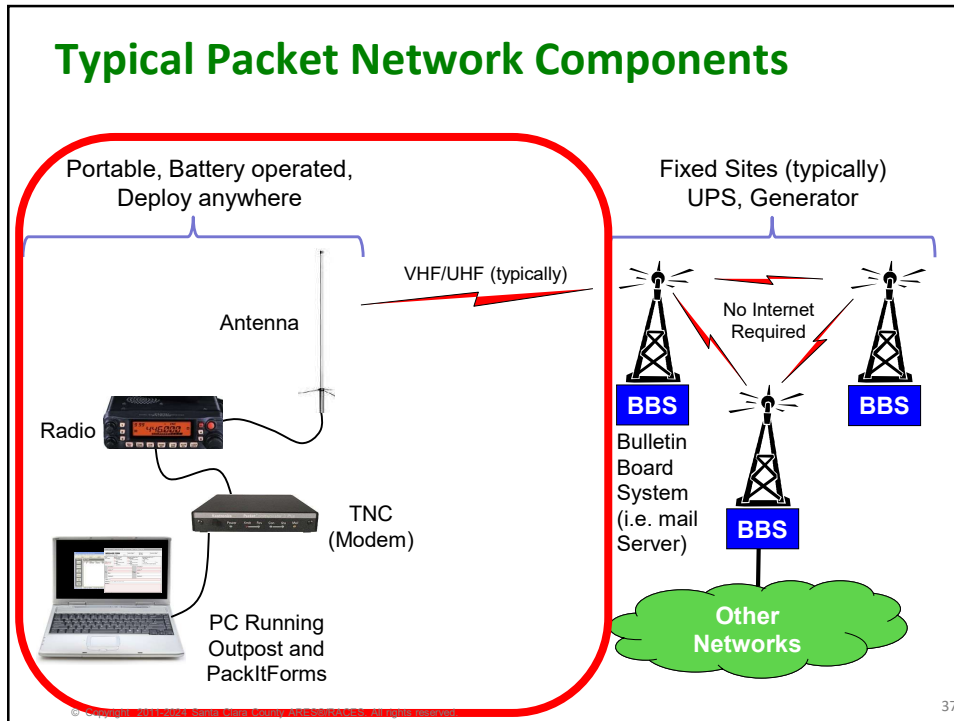

Packet Station Components (Details)

Santa Clara County ARES®/RACES

Home Services Operations Data Training & Events Reference About June 21, 2023

Network Access using AX.25 over VHF/UHF Amateur Radio

Overview | Services | Connect | Equipment | Resources

Overview

AX.25 is a protocol based on the X.25 protocol and uses amateur radio call signs for addresses. It is efficient for low bandwidth, noisy environments, such as VHF/UHF radio. This makes it ideal for access to the packet BBS network from anywhere in Santa Clara County. The use of VHF/UHF radio means RF coverage throughout the county is good enough for most locations to reach at least two of the packet BBS systems.

Accessible Services

AX.25 over VHF/UHF Amateur Radio can be used to access the following SCCo ARES/RACES service:

- Packet BBS Service
 - User Access: Users can connect to the packet BBSs using one of the VHF radio channels allocated for user access.
 - BBS Forwarding: Other packet BBSs can connect to the SCCo BBS network using AX.25 on a radio

Equipment and Software

- AX.25 over VHF Station Configuration Diagram (PDF)
- Consider the following when building an AX.25 (packet) over VHF radio station:
 - City/Agency EOC/DOC Equipment
 - Antenna
 - Feedline
 - Lightning Arrestor
 - Radio
 - TNC
 - USB-to-Serial Adapter
 - Computer
 - Printer
 - Software
 - Network
 - Power
 - Make sure your station helps to reduce/eliminate the "hidden node" problem

<https://www.scc-ares-races.org/data/access/ax25-vhf/ax25-vhf-access.html>

© Copyright 2011-2024 Santa Clara County ARES®/RACES. All rights reserved.

- Detailed information is available to help select each component of your packet station

38

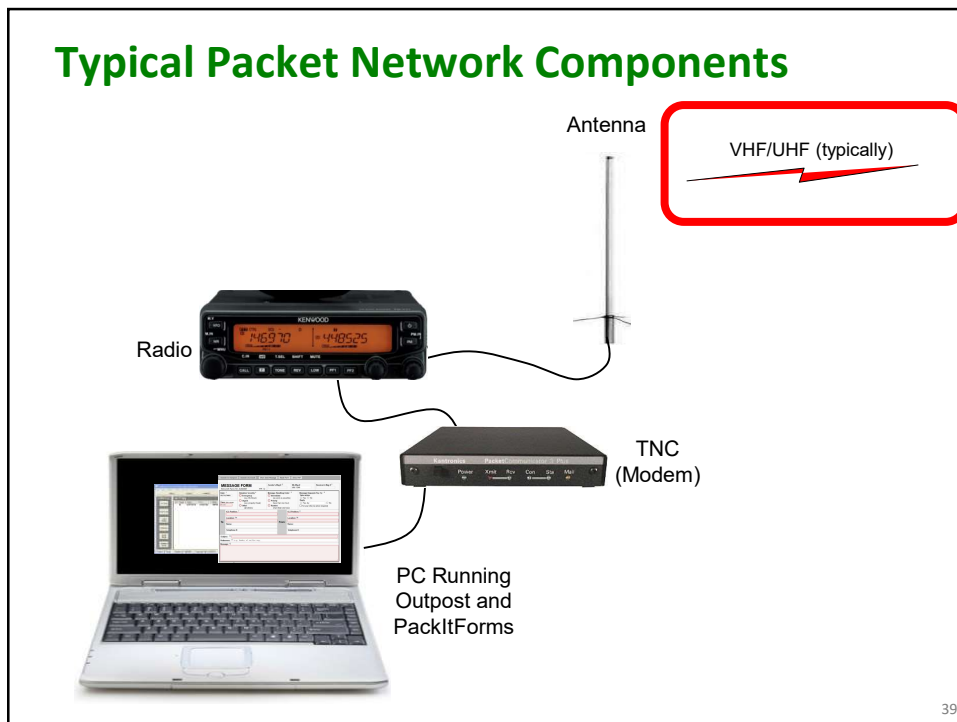

Access Frequencies

- Access is simplex with no tone
- 2m band access
 - User access; typically individuals, some EOCs
- 1.25m (220) band access
 - User access; typically EOCs, some individuals
- 70cm (440) band access
 - User access; typically individuals, some EOCs
- Advantages:
 - Simple antennas such as J-pole
 - Line of sight not required; county-wide coverage
 - But remember... do not be a "hidden node"

© Copyright 2011-2024 Santa Clara County ARES/RACES. All rights reserved.

40

Hidden Node Problem

- Affects ALL simplex communications (voice, packet, Wi-Fi, CW, ...)

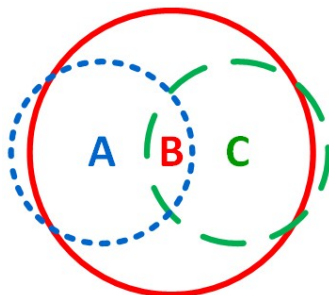

- Suppose: A & B can hear each other, and B & C can hear each other, but A & C cannot hear each other ...
- IF A transmits while C is transmitting (or vice versa), THEN B to hear a “double”. This causes message retries and slows down the channel for everyone.

© Copyright 2011-2024 Santa Clara County ARES/RACES. All rights reserved.

41

Hidden Node Solution

- Solution: don't be a hidden node!
 - Make sure your signal is heard by EVERYONE that is using the same BBS (multiple cities)
- Get your antenna up high
 - High enough that your signal is heard by as many people using the same BBS, as possible
- Use plenty of power
 - Enough that your signal is heard by as many people using the same BBS as possible

© Copyright 2011-2024 Santa Clara County ARES/RACES. All rights reserved.

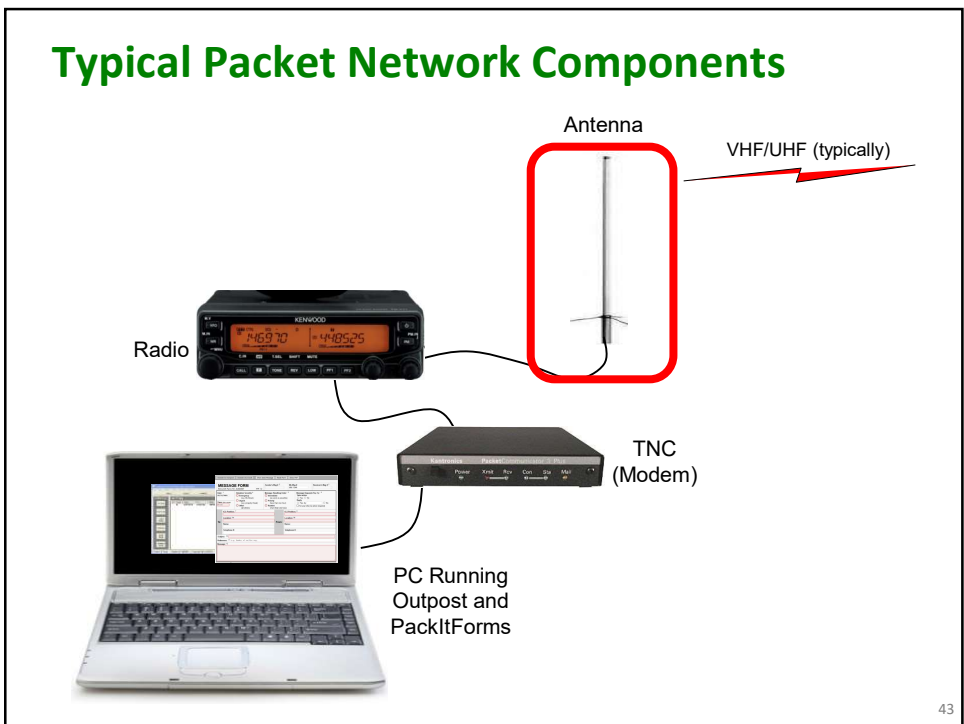

42





43

Antennas

- Get your antenna up high
- Home or EOC installation recommendation:
 - Tri-band ground-plane mounted on a tower or a mast above the roof
- Go Kit recommendation:
 - Roll-up j-pole antennas for 2m/440 and 220
 - 32 ft collapsible fiberglass windsock mast
 - Collapses to < 4 feet; weighs just a few pounds
 - Gets antenna above all 1-story and many 2-story buildings
 - Tripod with sandbags to support mast in wind
 - 50 feet of quality coax

© Copyright 2011-2024 Santa Clara County ARES®/RACES. All rights reserved.

44

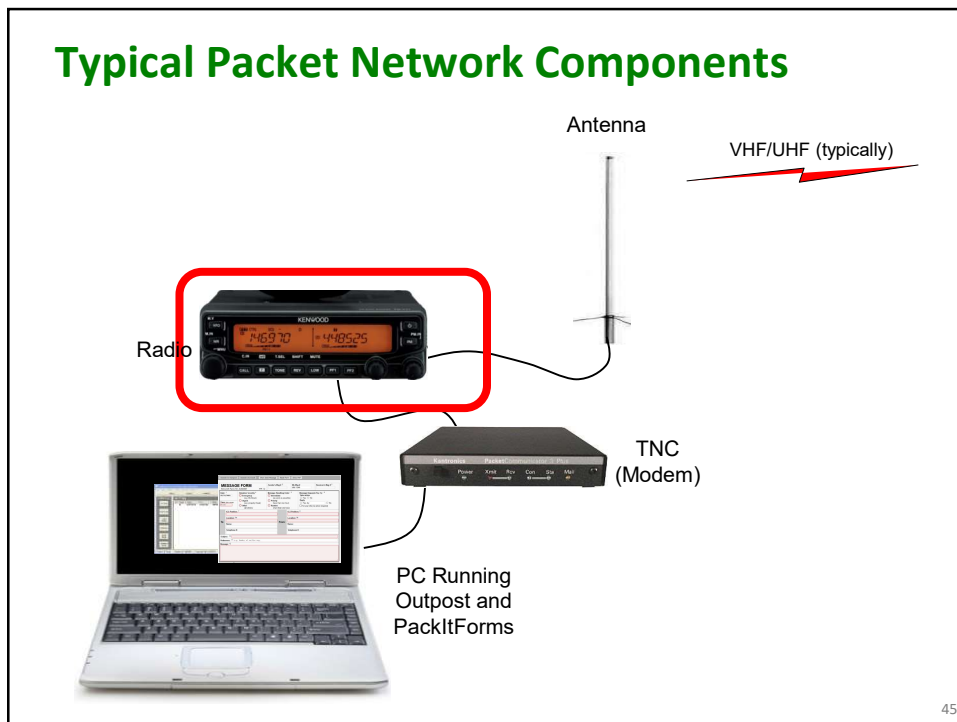

Radios

- Use plenty of power (25 to 50 Watts)
- Recommendation:
 - Mobile radio with 25 or more Watts of output
 - Data connector on back (usually 6-pin DIN)
 - Consistent audio levels between radio and TNC; unaffected by volume control
 - Allows operator to listen to speaker while operating
 - Dual receive – allows simultaneous monitoring of voice channel
- What about an HT?
 - Yes, it will work, BUT you will be a hidden node to everyone except your next door neighbors!
 - May be OK for hobby time or experimentation when the frequency is not busy (how would you know?), but will cause problems during real EmComm deployments.

© Copyright 2011-2024 Santa Clara County ARES/RACES. All rights reserved.

46

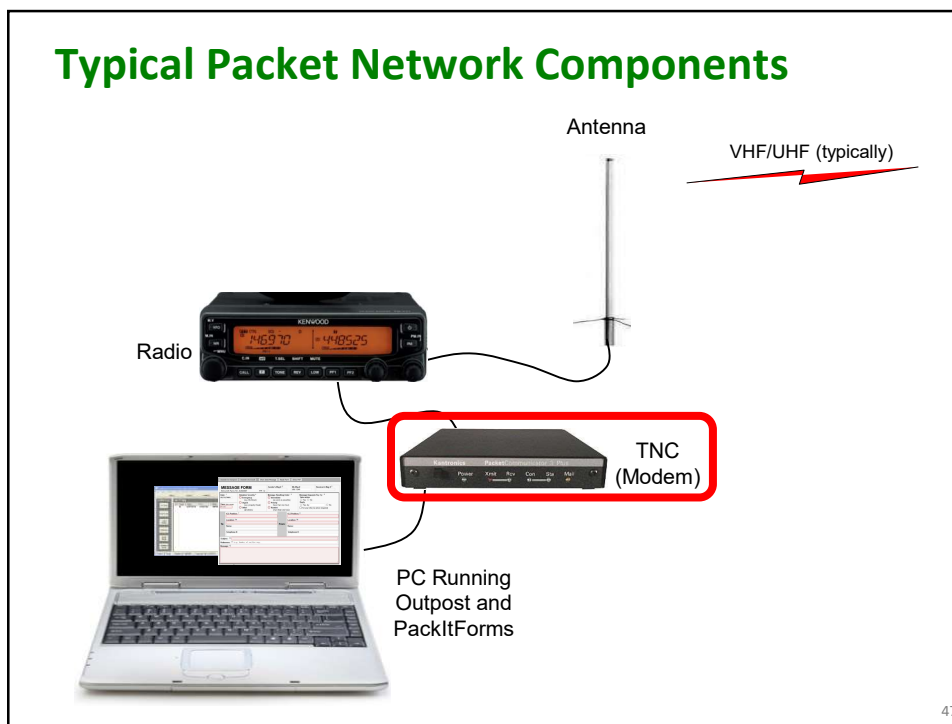

Terminal Node Controller (TNC)

- Reliable, consistent, out of the box operation needed
- Hardware TNCs preferred
 - County BBSs make extensive use of Kantronics KPC 3+ TNC
 - KPC 3+ has other features, such as:
 - Personal BBS, digipeater, node
 - Command line interface (Outpost not needed)
- What about software TNCs?
 - Yes, they will work
 - HOWEVER, experience shows they are finicky to set-up and operate; good for personal use or hobby work
 - But, not recommended for EmComm work

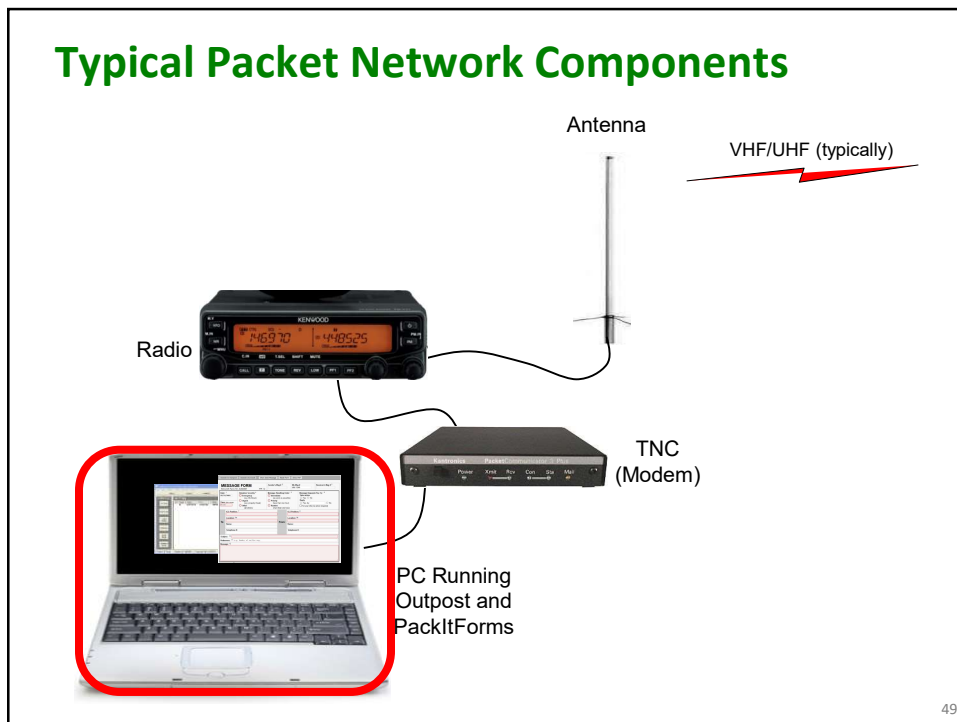

PC

- Characteristics
 - Must run a current version of MS Windows
 - Screen must be big enough to read and fill in large forms easily
 - Keyboard must allow for easy, reliable typing
 - Battery runtime of at least 1 hour
- Recommendation
 - Laptop or larger netbook running at least Windows 10
(end of W8.1 extended support: January 10, 2023... no more security updates)
- What about tablets?
 - As long as it runs Windows and has an external keyboard and mouse.
But most people find the screen sizes too small for extended use.
- What about Linux or MAC?
 - Not recommended. The software we use runs on Windows. Running a virtual machine or emulator just complicates things. Experience has shown that people who try this struggle to make it work effectively.

50

© Copyright 2011-2024 Santa Clara County ARES/RACES. All rights reserved.



Required for Type III Qualification

6. ASSEMBLING A PACKET STATION

© Copyright 2011-2024 Santa Clara County ARES/RACES. All rights reserved.

51

Type III Scenario

**W6XRL4, this is Xanadu
EOC**

This is W6XRL4, go ahead

**W6XRL4, please deploy to
Xanadu Community
Hospital and set up the
on site packet station.
Tactical call is XNDHSP.
Do you need directions?**

**Acknowledged. I know
the location and will
deploy immediately.
W6XRL4**

Xanadu EOC

© Copyright 2011-2024 Santa Clara County ARES/RACES. All rights reserved.

52

“Thinking outside the box”

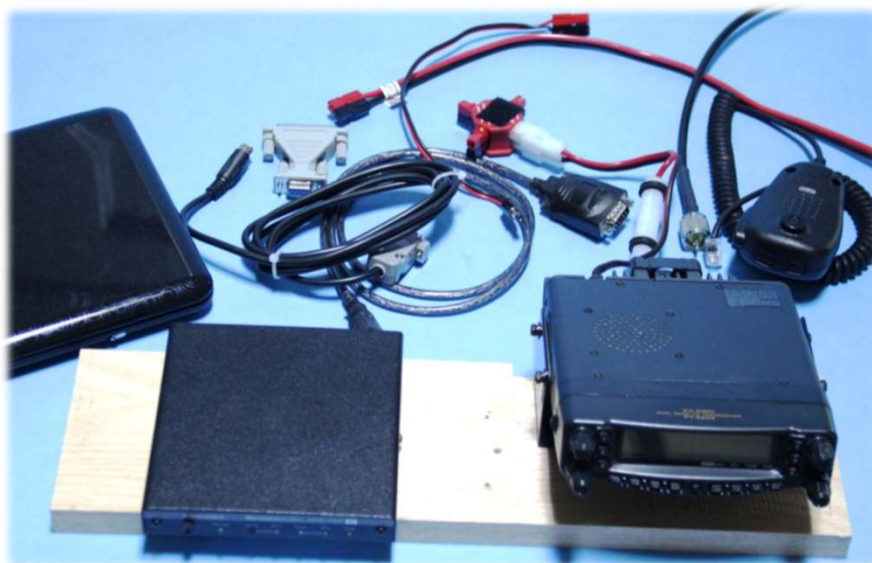

© Copyright 2011-2024 Santa Clara County ARES/RACES. All rights reserved.

53

But first, what’s in the box? (partial list)

Radio	2m, 220, 440, 25-50W Power Cable, adaptors 12VDC Microphone
Antenna	2m, 220, 440 roll-up J-Pole Mast, tripod, straps, sandbags, etc. 50ft of Coax
TNC	KPC-3+ Packet Communicator RS232 Serial cable to PC; 25pin/M to 9pin/F, or USB (newer KPC’s) Custom cable to Radio; 9pin/M to <whatever_your_radio_has> Cable to 12VDC
Laptop, PC	Windows PC, mouse (optional) USB-to-Serial Adaptor (older KPC3’s) or USB cable Power adaptor Mobile Printer, cable, power adaptor
Power	Battery or Power Supply Splitter, jumper cables

© Copyright 2011-2024 Santa Clara County ARES/RACES. All rights reserved.

54

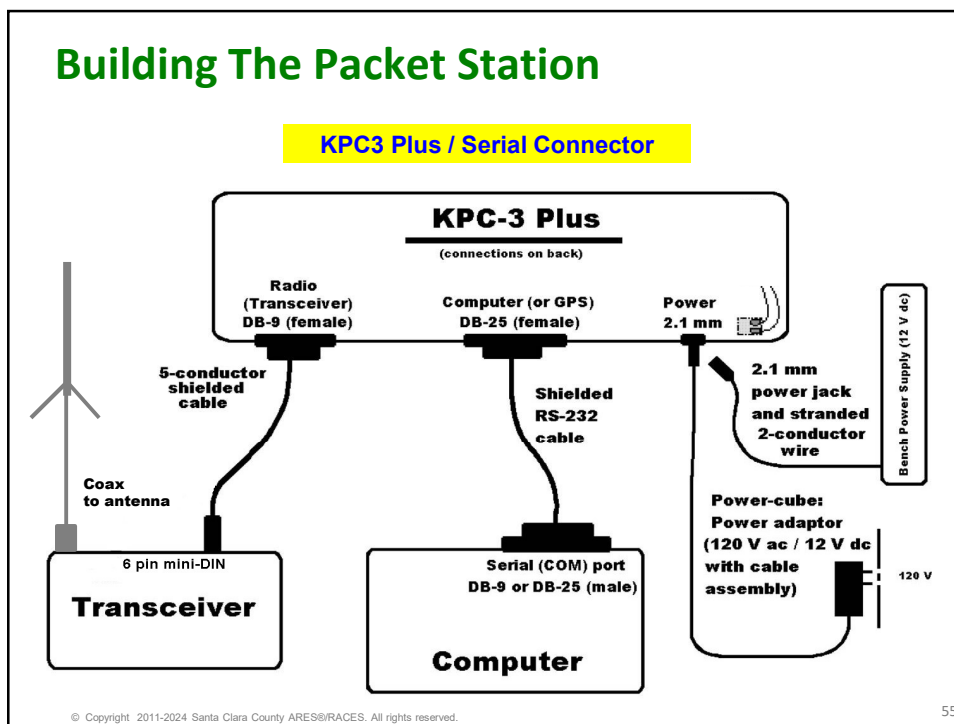

Connect TNC to PC

KPC3+ Serial port version

Radio Connection

Serial Connection

- KPC-3+ serial port has a DB-25 connector
 - DB-9 adapter may be needed
- Standard RS-232 serial cable; with USB-to-Serial for newer PCs
- **Caution – The Radio connector is a DB-9 !**
 - PTT, Transmit audio, Received Audio (NOT RS-232!)

© Copyright 2011-2024 Santa Clara County ARES/RACES. All rights reserved. 56

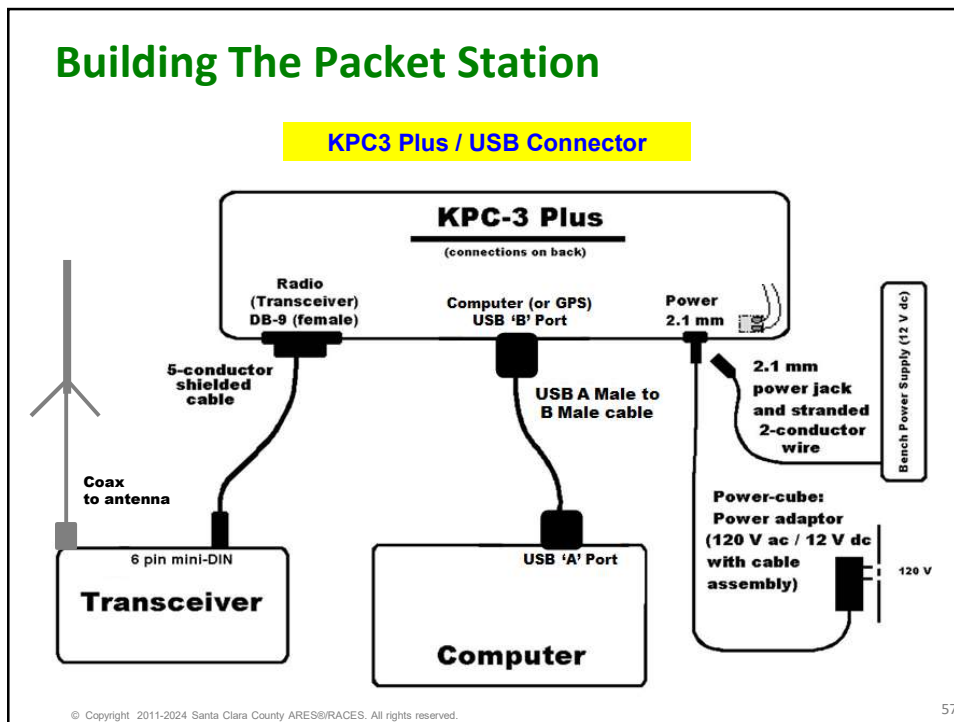

Connect TNC to PC

KPC3+ USB version

Radio Connection

USB 'B' Connection

- KPC-3+ USB port is a 'B' connector
- No longer requires a separate USB-to-Serial adaptor (FTDI USB chip is built in); **BUT...** not the case for other TNCs
- Caution – The Radio connector is a DB-9 !**
 - PTT, Transmit audio, Received Audio (NOT RS-232!)

© Copyright 2011-2024 Santa Clara County ARES/RACES. All rights reserved. 58

Connect TNC to Radio

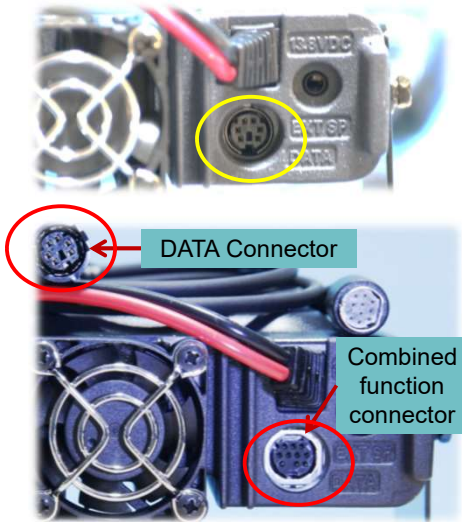

- Most radios have a dedicated 6 pin mini-DIN DATA connector
- Some have a combined 8 pin mini-DIN connector and a breakout cable
– **Best Option!!**
- Otherwise, you will use the speaker and mike connectors

© Copyright 2011-2024 Santa Clara County ARES/RACES. All rights reserved.

59

Connect TNC to Radio



- KPC-3+ has a DB-9 connector
- Radio will have a dedicated “data” connector for packet
 - 6 pin mini-DIN
 - May have to use mic connector and external speaker

© Copyright 2011-2024 Santa Clara County ARES/RACES. All rights reserved.

60

A note on the Alinco radios for packet

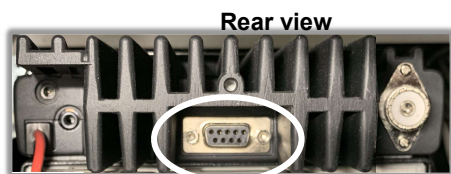

DATA Connector

- Alinco DR-135T (2m), DR-235T (220) and DR-435T (440) are single-band radios and very popular for packet.
- The radios use a DSUB-9 connector for their data port.
- **Do not use** the internal *EJ-41U module* as a TNC; it has insufficient memory for ECOMM message passing.
- For an **external TNC**, **do not use a standard RS-232 modem cable!** You need a **custom cable** for **PTT, Transmit Audio, Receive Audio, and GND**.

However... the DR-135T, DR-235T, and DR-435T are no longer in production, but could be found in the 2nd hand market.

© Copyright 2011-2024 Santa Clara County ARES/RACES. All rights reserved.

“Got My Act Together”

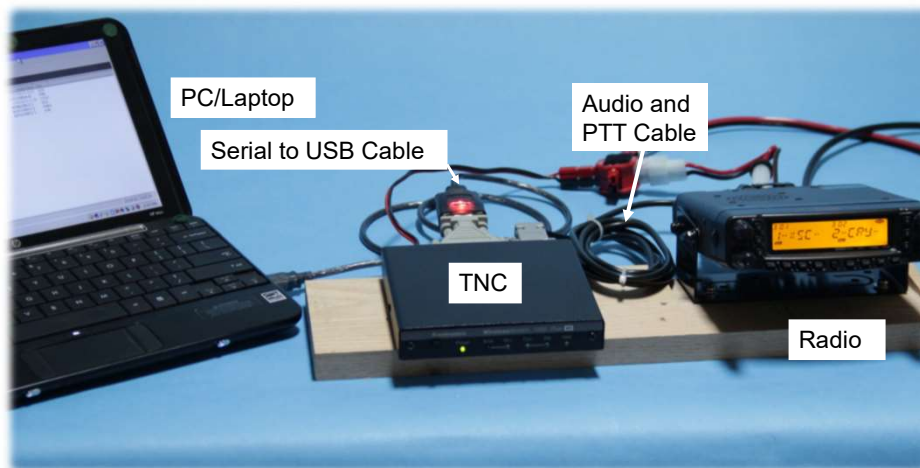

© Copyright 2011-2024 Santa Clara County ARES/RACES. All rights reserved.

PC Setup



- Secure a work area suitable for computer use
 - Protected
 - Out of sunlight
 - AC power, if possible
- Set up PC
 - Verify that Outpost and PacketForms are installed
 - Verify the version
 - Set up user identification and Tactical ID (if needed)
 - Make sure computer date and time are set correctly
 - Verify correct Profile
 - Verify BBS and TNC settings
 - Adjust other settings as needed for the assignment

© Copyright 2011-2024 Santa Clara County ARES/RACES. All rights reserved.

63

Creative “Get-out-of-the-Sun” ideas



© Copyright 2011-2024 Santa Clara County ARES/RACES. All rights reserved.

64

Radio Settings



- Consult radio manual for packet settings
 - Packet or data mode
 - Packet baud rate – 1200 bps
 - If Dual Receive, which side does Packet use?
 - Simplex
 - No tone or tone squelch
 - Yaesu users - make sure WIRES is off
 - RF squelch/S-meter squelch to minimum
 - Turn off any function that might interrupt radio function
 - 25 W or more transmit power

© Copyright 2011-2024 Santa Clara County ARES/RACES. All rights reserved.

65

KPC-3+ Setup Overview

- Use a *terminal emulator* (such as Outpost's Ipserial program) to communicate with the TNC
 - Verify Com Port settings
 - Verify that TNC "connected" – "**cmd:**" prompt
 - Adjustment of serial connection baud rate may be needed
- Use the Command mode to instruct the TNC
 - Actions to be performed
 - Parameters to be set
 - Diagnostic information

© Copyright 2011-2024 Santa Clara County ARES/RACES. All rights reserved.

66



Outpost and PackItForms

7. NOW THE SOFTWARE...

© Copyright 2011-2024 Santa Clara County ARES/RACES. All rights reserved.

67

What is Outpost?

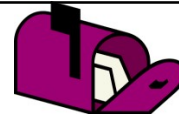

- A Windows-based packet messaging client; email-like GUI; hides the complexity of the packet world
- Helps ARES, RACES, and other amateur radio emergency response teams meet the needs of their served agencies
- Automates and manages all message handling between you and your BBS
- Lets you read, delete, create, send, reply to, and forward messages back to the BBS
- SCCo Packet Installer is available from County web site
 - www.scc-ares-races.org/data/packet
- General release version available from Outpost web site
 - www.outpostpm.org

© Copyright 2011-2024 Santa Clara County ARES/RACES. All rights reserved.

68

Install Santa Clara County Version

- Combined Installer for Outpost & PackItForms
 - Unique directory names
 - Programs: C:\Program Files (x86)\SCCo Packet
 - Data: C:\SCCo Packet
 - Does not interfere with general release version of Outpost on the same machine
- Includes all updates
 - Standard TNC and County BBS setups
 - Standard County user settings
 - Standard County forms
 - Updates will not overwrite user defined settings



© Copyright 2011-2024 Santa Clara County ARES/RACES. All rights reserved.

69

Install Outpost and PackItForms

- Single click install process for both Outpost and PackItForms
- Click the defaults

Start

Finished

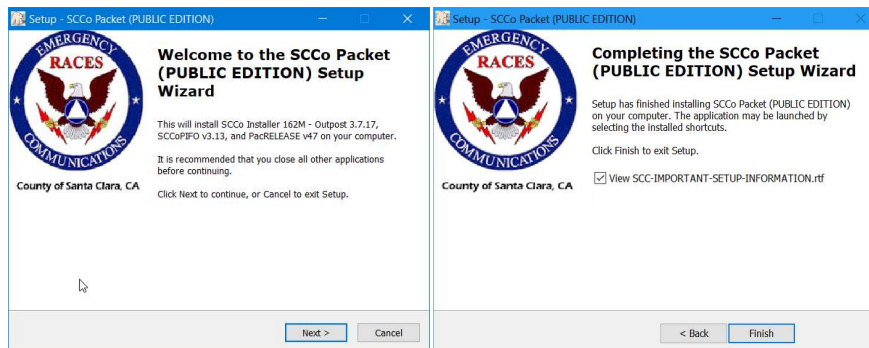

© Copyright 2011-2024 Santa Clara County ARES/RACES. All rights reserved.

70

Confirming the installed version

```

SCCo Version Information
=====
This release contains the following:
1. Install: v162M
2. Outpost: v3.7.17
3. PIFO: v3.13
4. PacRELEASE: v4.7

Build Date: 21 September 2023

For Outpost release details, do the following:
1. Run Outpost
2. From the main menu, press Actions > "View Outpost Data Directories"
3. Double-click on the file "README370.txt"

For SCCoPIFO details, see UserGuide.html located at "c:\PackItForms
\Outpost\SCCo".

For PacFORMS release details, see the various Readme files located at
"c:\PacFORMS\Docs".
    
```

From the Start Menu, look for **SCCo Packet** under:

- Windows 10: Start > scroll down through the list of apps
- Windows 11: Start > All Apps, scroll down through the list of apps

Confirming the installed version

Outpost Startup



Outpost: Help -> About

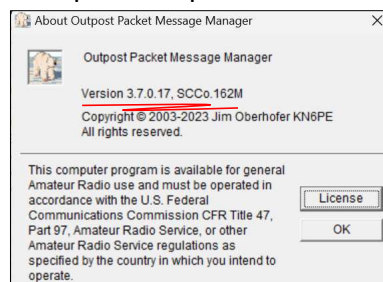

Setting up Outpost's User ID

Outpost Setup > Station ID

- Previously setup? Select your call from the **User Call Sign** drop down
- First time user setup? Press New
- Fill in all Legal ID fields:
 - User call sign
 - User Name (Your full name)
 - Message ID Prefix
 - Defaults to the last 3 letters of your call sign
- To change from FCC call to Tactical
 - Click/Uncheck - **Use Tactical Call**
 - When unchecked and fields are greyed out, you are using your FCC call
- Press OK when done
- When you take over a shift as a Packet Operator, you will need to change the User Call sign and User Name

Station ID is W6XRL4

Identification | BBS Logins | Signatures |

Current Profile: Outpost

Legal

User Call Sign: W6XRL4 [New]

User Name: Herman Munster [Delete]

Message ID Prefix: RL4 (3 Characters max)

Tactical

Use Tactical Call for all BBS interaction

Tactical Call Sign: XNDEOC [New]

Additional ID Text: Xanadu EOC [Delete]

Message ID Prefix: XND (3 Characters max)

Show this form on startup [OK] [Apply] [Cancel]

© Copyright 2011-2024 Santa Clara County ARES/RACES. All rights reserved.

73

Tactical Calls

Outpost Setup > Station ID

- Tactical Calls are assigned to support message processing
 - Independent of operator's FCC call sign
- Once added to BBSs:
 - Packet users can log in with city tactical call signs
- Updates occur upon request from an agency
- Tactical calls for your city are available from your EC
- Tactical calls also added for Coastal Region and all surrounding counties
- To request new or update your agency's tactical calls, see:
 - <http://www.scc-ares-races.org/data/packet>
 - "How to Request Tactical Calls"

© Copyright 2011-2024 Santa Clara County ARES/RACES. All rights reserved.

74

Setting up a Tactical Call ID

Outpost Setup > Station ID

- If Using a Tactical Call, check the "Use Tactical Call ..." box
- Previously setup? Select the tactical call from the **Tac Call Sign** drop down
- First time Tac call setup? Press New
- Fill in all Tactical fields:
 - Call Sign
 - Additional ID Text
 - Message ID Prefix
 - 3 letter prefix used in msg number
 - Set per your served agency policy
- Press OK when done
- When you take over a shift as a Packet Operator, you will need to change the User Call sign and User Name, and confirm the tactical call

The screenshot shows a dialog box titled "Station ID is W6XRL4 as XNDEOC". It has tabs for "Identification", "BBS Logins", and "Signatures". The "Current Profile" is "Outpost". Under the "Legal" section, "User Call Sign" is "W6XRL4", "User Name" is "Herman Munster", and "Message ID Prefix" is "RL4". Under the "Tactical" section, the checkbox "Use Tactical Call for all BBS interaction" is checked. "Tactical Call Sign" is "XNDEOC", "Additional ID Text" is "Xanadu EOC", and "Message ID Prefix" is "XND". There are "New" and "Delete" buttons for both the Legal and Tactical sections. At the bottom, there is a "Show this form on startup" checkbox and "OK", "Apply", and "Cancel" buttons.

© Copyright 2011-2024 Santa Clara County ARES/RACES. All rights reserved.

75

Confirming the PC Time

Outpost Startup > time check

- Old and/or seldom-used PCs are usually not set to the correct time
- Outpost and PackItForms use the PC time
- If wrong, causes incorrect and confusing information on message listing and logs
- On startup, Outpost displays the current PC time and offers a chance to change it

The screenshot shows a dialog box titled "PC Time Check v3.5.0". It displays "Your PC's current time" as "Wednesday, 28-Jul-2021 08:37:01". Below this, it says "If the Date or Time is incorrect, then press Update and set the correct date and time for your PC." There are "Update" and "Close" buttons.

The screenshot shows the Windows "Date and Time" settings window. It has tabs for "Date and Time", "Additional Clocks", and "Internet Time". The "Date and Time" tab is active, showing a clock, the date "Wednesday, July 28, 2021", and the time "8:37:31 AM". There are "Change date and time..." and "Change time zone..." buttons. The time zone is "(UTC-08:00) Pacific Time (US & Canada)". There is a note about Daylight Saving Time ending on Sunday, November 7, 2021 at 2:00 AM. The "Notify me when the clock changes" checkbox is checked. There are "OK", "Cancel", and "Apply" buttons at the bottom.

© Copyright 2011-2024 Santa Clara County ARES/RACES. All rights reserved.

76

Confirming the Station ID

Outpost Setup > Station ID

- **FCC Call** - Only the call sign is listed

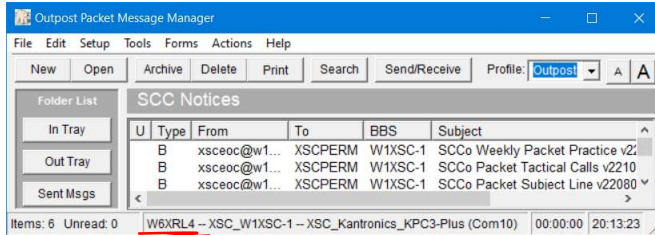

- **Tactical Call** – listed as “<call_sign> as <tactical_call>”

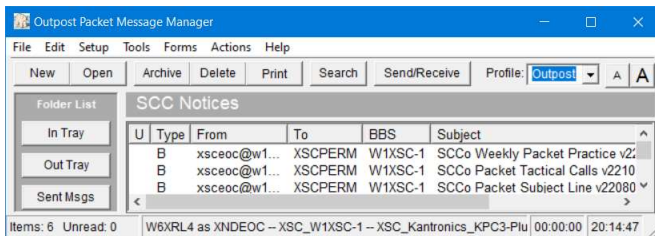

© Copyright. 2011-2024 Santa Clara County ARES/RACES. All rights reserved.

77

Outpost - A Closer Look

Main form controls

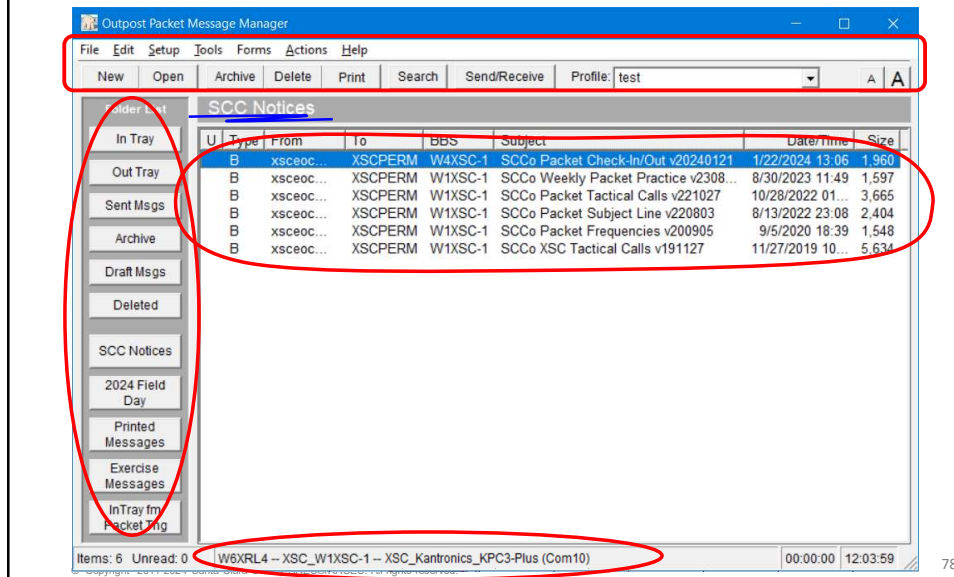

Outpost – Profiles

Main form controls

- Profiles store Outpost settings under a name
 - Tools menu settings, Station Identification, BBS, TNC selection, etc.
 - The “OUTPOST” profile contains all of the default SCCo settings
- Switch between profiles without restarting Outpost
- Verify that the Profile is correct

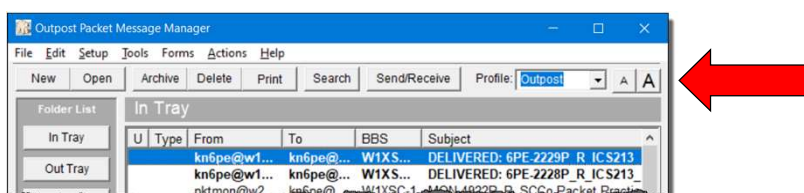

© Copyright 2011-2024 Santa Clara County ARES/RACES. All rights reserved.

79

Configuring Outpost

Setup menu

All configuration items are under two Menu items

- The **Setup** menu...
 - **BBS...** Santa Clara County BBS's are preloaded
 - **Interface...** Preconfigured TNCs
 - **Station ID...** for setting your FCC and tactical call
 - **Address Book...** create alias and distribution lists
 - **Profiles...** manage different configurations
 - **PC Time Check...**

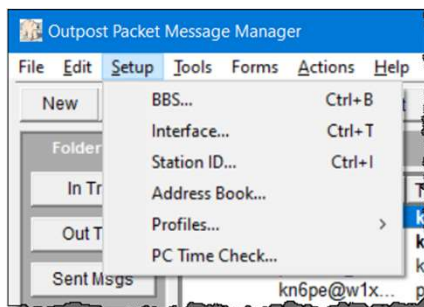

© Copyright 2011-2024 Santa Clara County ARES/RACES. All rights reserved.

80

Configuring Outpost

Tools menu

All configuration items are under two Menu items

- The **Tools** menu...
 - **Send/Receive...** Automation, Auto Printing, etc.
 - **Message...** defaults, numbering, receipts
 - **Log settings...** helps with troubleshooting
 - **General...** Print settings, name extra folders
 - Running programs or scripts
 - Column resets
 - Manual packet programs

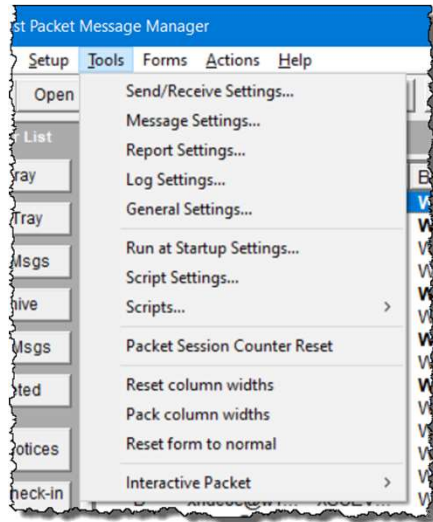

© Copyright 2011-2024 Santa Clara County ARES/RACES. All rights reserved.

Configuring Outpost

Tools menu > Message Settings > Msg Numbering Tab

- Add message number...
 - With hyphenation
- Add message number suffix. Adds a "P" suffix to all inbound and outbound message numbers
 - Check this box
 - Plain Text
 - PacketForms
- Add message num separator
 - leave unchecked
- Assign a local message ID
 - check this box
- Message numbering is common across profiles
 - Numbers are common across all profiles

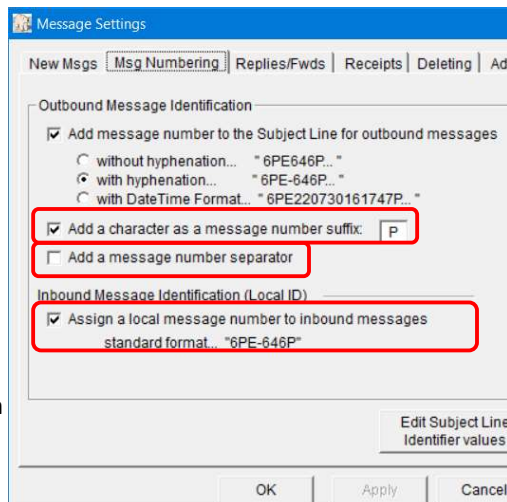

© Copyright 2011-2024 Santa Clara County ARES/RACES. All rights reserved.

82

Working with messages

Viewing messages – Plain Text

- Supports viewing, printing, deleting or saving a message to a local file
- Reply and Forward message formatting
- To view a message,
 1. Highlight, then press Open, or
 2. Single-click then press Enter

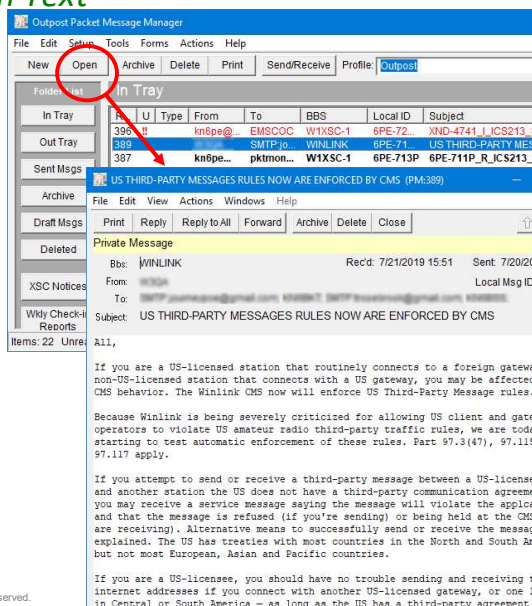

© Copyright 2011-2024 Santa Clara County ARES/RACES. All rights reserved.

Working with messages

Viewing messages – PackItForms

- What if it is a PackItForm?
- To view a message,
 1. Highlight a PackItForms message, then press Open, or
 2. Right-click to open the popup menu

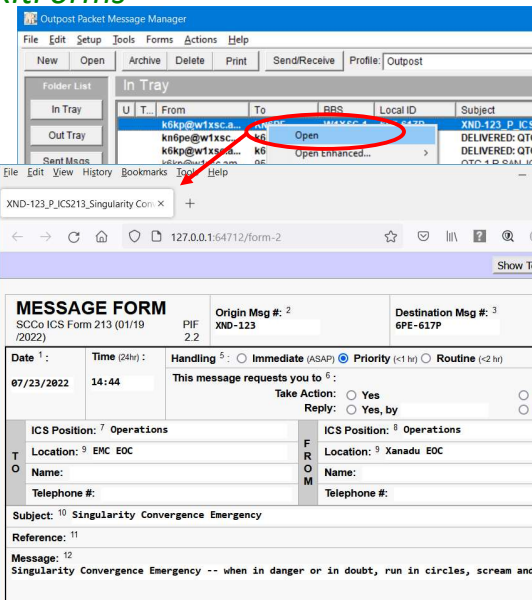

© Copyright 2011-2024 Santa Clara County ARES/RACES. All rights reserved.

Working with messages

Creating messages

- Start a new message:
 1. Press New
 2. Fill in all remaining fields
- Multiple message sourcing options
 1. Free-form: what you see is what you get
 - Supports TAB characters thereby reducing the character count
 2. Cut and Paste from other apps, like notepad, Excel
 3. Import .csv files
 4. Import text files directly into the message form
 5. Press **Send** or **Save** when done

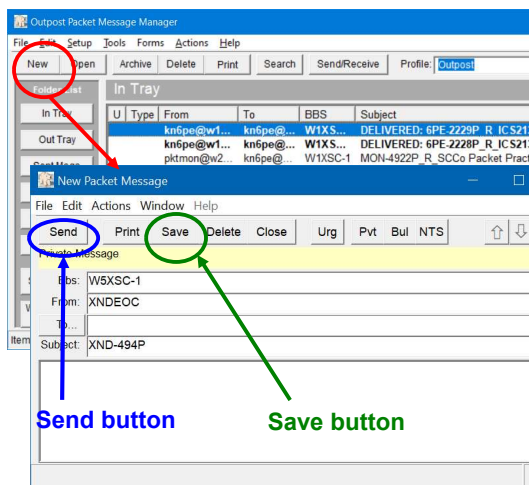

© Copyright 2011-2024 Santa Clara County ARES®/RACES. All rights reserved.

85

Watch out for Drafts

Creating messages

Folder List		Out Tray					
		U	Type	From	To	BBS	Subject
In Tray							
Out Tray		D...	KN6PE	cupcsa@w1...	cupeoc...	W1XSC-1	CSA-231 R SitStat-Creekside.csv
		D...	KN6PE	95825@...	K6FB-2	QTC 1 R SACRAMENTO CA 916 555	

- If you click **“Save”**, the message is saved as a DRAFT and will not be sent
 - The blue highlighted text means it is a DRAFT message
 - Lose your Saved Message? Check the Draft Folder
- If you click **“Send”**, the message will be saved, and
 - A black text entry means it is ready to be sent
- Check the **Out Tray** after a **Send/Receive** to make sure your messages were sent

© Copyright 2011-2024 Santa Clara County ARES®/RACES. All rights reserved.

86

Message form specifics

Creating messages

- Message character counter
 - Watch when preparing large messages... this is a shared channel
- Moving between messages
 - Up/Down arrows allow easy movement to previous or next message
- Urgent Message
 - Flags a message as urgent and displays in **RED** in your folders and the receiving station
- Address Book entries
 - Press To: button to select previously defined address book entries

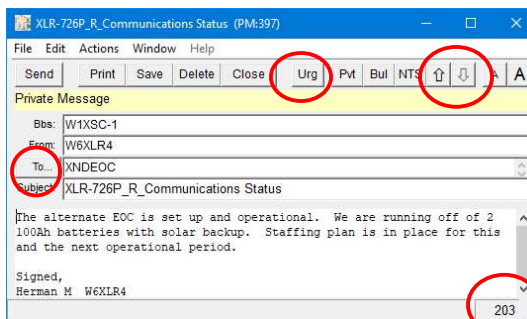

© Copyright 2011-2024 Santa Clara County ARES/RACES. All rights reserved.

87

Outpost Workflow

How it Gets Done

1. On Outpost: press “New” to create a new message
2. On the Message Form
 - Compose the message. Fill in all blank fields
 - Press “**Send**” – message is moved to Out Tray (Press “**Save**” to store to the **Draft Msgs** folder)
3. On Outpost: Press “Send/Receive”
 - Looks for and sends messages from the **Out Tray** for this User and BBS
 - When sent, the message is moved to the **Sent Msgs** folder
 - Checks for and retrieves new messages, places them in bold in **In Tray**
 - If requested, DELIVERY RECEIPTS are sent back to the originator
4. Read and handle new messages
5. Print, Delete, Archive, or move messages to a folder as needed
 - Deleted messages are automatically moved to Deleted Messages folder



If you think there is a problem with a message, refer the message to your Shift Supervisor for resolution

© Copyright 2011-2024 Santa Clara County ARES/RACES. All rights reserved.

88

Outpost do's and don'ts

- DO...
 - Keep your message short enough to communicate what needs to be passed... same as a voice message
 - Be Patient; after your message is downloaded by the recipient, they will send a delivery receipt. Then you will retrieve it on your next Send/Receive session.
- DON'T...
 - Continuously press Send/Receive to check for a reply. This ties up the channel needlessly.
 - If a message was not acknowledged:
 - Check the message address and BBS
 - Resend the message if needed
 - Let your supervisor know

© Copyright 2011-2024 Santa Clara County ARES/RACES. All rights reserved.

89

PackItForms

The screenshot displays the PackItForms application interface, which is a web-based form system. It features several overlapping windows, each representing a different form used for reporting incidents and resource requests. The forms are organized into a stack, with the most recent or active form in the foreground.

Key forms visible include:

- Santa Clara County EOC Resource Request Form 213RR**: A form for requesting resources from the Emergency Operations Center (EOC).
- Santa Clara OA Jurisdiction Status**: A form for reporting the status of jurisdiction for the Office of the Assessor (OA).
- Santa Clara OA Shelter Status**: A form for reporting the status of shelters.
- Allied Health Status Report Short Form (DEOC-9)**: A form for reporting the status of allied health personnel.
- Santa Clara County RACES -- Mutual Aid Request**: A form for requesting mutual aid resources from the Radio Amateur Emergency Society (RACES).

The interface includes various input fields, dropdown menus, and buttons for submitting forms. The background shows a grid of data, likely representing a list of messages or reports. The overall design is functional and focused on data entry for emergency services.

© Copyright 2011-2024 Santa Clara County ARES/RACES. All rights reserved.

90

Introduction to PackItForms



- PackItForms are an enhanced tool for forms-based messaging and supports sending Santa Clara County forms by packet radio
 - Minimizes data actually sent
 - Web tool to “fill in the blanks”
 - Entered information is extracted from the forms to build up a text message that is then sent.

© Copyright 2011-2024 Santa Clara County ARES/RACES. All rights reserved.

County Use of PackItForms

- Santa Clara County PackItForms contains these public forms
 1. *XSC Check-In/Out Message* Form
 2. *XSC ICS-213 Message* Form adapted for Santa Clara County to transmit messages.
 3. *XSC EOC-213RR Resource Request* Form – Requests specific resources needed to support an emergency.
 4. *XSC OA Jurisdiction Status* Form – Reports jurisdiction emergency situation status to county OEM.
 5. *XSC OA Shelter Status* Form – Reports information and status on shelters opened in the cities to county OEM.
 6. *XSC Allied Health Facility Status* – Reports information & status of private Skilled Nursing facilities to SCC Public Health Department.
 7. *XSC RACES Mutual Aid Request* Form used by a jurisdiction to request a RACES Mutual Aid.
- The SCC Installer program automatically installs these packet forms along with Outpost.
 - Additional forms may be provided by your EC

PackItForms and Outpost

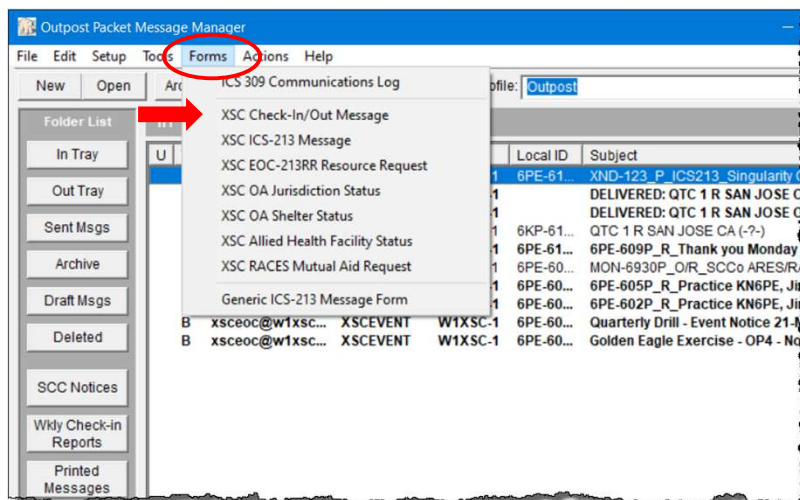

© Copyright 2011-2024 Santa Clara County ARES/RACES. All rights reserved.

93

XSC Check-In/Out Message

- For check-in and check-out messages
- Most fields are automatically filled in
 - Message Number
 - Call Sign
 - Name
- If **Use Tactical Call** is checked,
 - Tactical Call
 - Tactical Name
- Make your selections:
 - Check-in or Check-out
 - Use Tactical Call

© Copyright 2011-2024 Santa Clara County ARES/RACES. All rights reserved.

94

XSC ICS 213 Message Form

95

- SCC IS 213 Message Form
 - Message Number Fields
- Paper form should come to you already filled out
 - If you have to fill it out, have the originator review and initial it
- For drills, fill in the blanks just like the paper version
- No need for 5 words per line
- Replies to a received message must have the original message number in the reference line

XSC EOC Resource Request 213RR

96

- For material, equipment, and staff requests, never for RACES Mutual Aid
- Signature Checkbox
 - with signature
- *Form defaults*
 - To ICS Position: **Planning Section**
 - To Location: **County EOC**
- **Note!** Fields can be changed at message create time
- Paper form should come to you already filled out
- Should answer
 - What do you need
 - Who needs it
 - Where do you need it
 - When do you need it
 - How long do you need it
 - How do you get there

Medical Resource Request forms also have a new ' with signature ' checkbox.

XSC OA Jurisdiction Status Report

- For jurisdiction status & incident reporting to County EOC
- *Form defaults*
 - Handling Order: **Immediate**
 - To ICS Position: **Situation An...**
 - To Location: **County EOC**
- Paper form should come to you already filled out
- Replaces the City Scan form

Note 2024!
For all IMMEDIATE packet messages, notify the recipient on the COMMAND Net as soon as it is sent.

XSC OA Shelter Status Report

- For local shelter status reporting
- New layout better aligns with the .pdf
- *Form defaults*
 - Handling Order: **Priority**
 - To ICS Position: **Mass Care and...**
- **Note!** Fields can be changed at message create time

XSC Allied Health Status Report

Allied Health Status Report Short Form (pEOC-9) Version: February 2018 PIF: 2.3

Message Numbers: Origin: RL4-2253P Destination: []
 Date: 06/21/2023 Time: [hh:mm] Handling: Immediate (ASAP) Priority (<1 hr) Routine (<2 hrs)

ICS Position: EMS Unit ICS Position: []
 Location: MHJOC Location: []
 Name: [] Name: []
 Contact Info: [] Contact Info: []

Report Type: Update Complete

Facility Name: [] Facility Type: [] Date: 06/21/2023 Time: [hh:mm]

Contact Name: [] Phone # [000-000-0000 x00] Fax # [000-000-0000 x00]

Other Phone, Fax, Cell Phone, Radio: [] Incident Name and Date: [mm/dd/yyyy]

Facility Status: Green - Fully Functional Red - Limited Services Black - Impaired/Closed

Additional Attachments Provided: NHCS/ICS Organization Chart DEOC/SA Resource Request Forms NHCS/ICS Status Report Form - Standard NHCS/ICS Incident Action Plan Phone/Communications Directory

Facility Contact Information: Facility EOC Main Contact Number [000-000-0000 x00] Facility EOC Main Contact Fax [000-000-0000 x00] Facility Liaison Officer Name: Liaison to Public Health/Medical Health Branch Facility Liaison Contact Number [000-000-0000 x00] Facility Information Officer Name [] Facility Information Officer Contact Number [000-000-0000 x00] Facility Information Officer Contact Email []

If Facility EOC is Not Activated, Who Should be Contacted for Questions/Requests: [000-000-0000 x00] Bed Resource Availability: Staffed Bed M [] Staffed Bed F [] Vacant Beds M [] Vacant Beds F []

Facility Contact Number: [000-000-0000 x00] Facility Contact Email: []

© Copyright 2011-2024 Santa Clara County ARES/RACES. All rights reserved. 99

- For skilled nursing facility status reporting
- *Form defaults*
 - Handling Order: **Routine**
 - To ICS Position: **EMS Unit**
 - To Location: **MHJOC**
 - **Note!** Fields can be changed at message create time
- Hand off SCC Public Health Department

XSC RACES Mutual Aid Request

Santa Clara County RACES - Mutual Aid Request Version: 20220129 PIF: 2.4

Message Numbers: Origin: RL4-2254P Destination: []
 Date: 06/21/2023 Time: [hh:mm] Handling: Immediate (ASAP) Priority (<1 hr) Routine (<2 hrs)

ICS Position: RACES Chief Radio Officer ICS Position: []
 Location: County EOC Location: []
 Name: [] Name: []
 Contact Info: [] Contact Info: []

Agency Name: []
 Event / Incident Name: [] Number: []

Assignment: []
 Amateur Radio Resources Requested: []
 Requested Arrival: Date(s) [] Time(s) []
 Needed Until: Date(s) [] Time(s) []
 Reporting Location: []
 Contact on Arrival: []
 Requested By: Name [] Title [] Contact []
 Approved By: Name [] Title [] Contact [] Signature with signature Date: 06/21/2023 Time: [hh:mm]

Radio Operator Only: Relay: [] Revd: [] Sent: [] Name: Herman Munster Call Sign: 460XRL4 Date: [] Time: []

99

- For RACES Mutual Aid requests only
- Signature Checkbox
 - with signature
- *Form defaults*
 - Handling Order: **Routine**
 - To ICS Position: **RACES Chief...**
 - To Location: **County EOC**
 - **Note!** Fields can be changed at message create time
- For jurisdiction material, equipment, and staff requests, use the ICS 213RR form.

Message numbers

Considerations

- If you are given a paper form with an existing message number, do not change it!
- For instance: If you are given this:

MESSAGE FORM
 For paper: use ballpoint pen – blue or black ink only (See back for instructions)

Origin Msg #: **XND-123** Destination Msg #:

Handling ⁵(✓one): Immediate (ASAP) Priority (< 1hr) Routine (< 2hr)

- then replace the Outpost-generated number with:

Submit to Outpost Submit via Email Reset Form Show PDF = required Show Text Message

MESSAGE FORM
 SCCo ICS Form 213 (01/19/2022) PIF 2.2

Origin Msg #: **XND-123** Destination Msg #:

Date ¹: Time (24hr): Handling ⁵: Immediate (ASAP) Priority (< 1 hr) Routine (< 2 hr)

- It's that simple!

© Copyright 2011-2024 Santa Clara County ARES/RACES. All rights reserved.

101

What Really Gets Sent

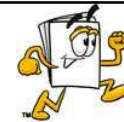

- PacketForms creates the Outpost subject line automatically
- Subject line and message body are locked (grayed out); cannot be changed.
- If you need to make changes,
 - Open (or double-click on) the message in Outpost
 - it will open in the Browser and now can be updated,
 - Then press “Submit to Outpost” to resubmit the updated message.

XND-123_I_CS213_Singularity Convergence Emergency (PM:398)

Send Print Save Delete Close Urg PM Bul NTS ↑ ↓ A A

Urgent, Private Message

Bbs: W1XSC-1
 From: KN6PE
 To: XNDEOC
 Subject: XND-123_I_CS213_Singularity Convergence Emergency

!SCCoPIFO!
 #T: form-ics213.html
 #V: 2.6-1.2
 MsgNo: [XND-123]
 1a.: [07/27/2019]
 4.: [EMERGENCY]
 5.: [IMMEDIATE]
 6a.: [No]
 1b.: [21:38]
 7.: [Operations]
 8.: [Operations]
 9a.: [EMC EOC]
 9b.: [Sanadu EOC]
 10.: [Singularity Convergence Emergency]
 12.: [Yes, it is happening, and there is nothing we can do to stop it. When in danger or in doubt, run in circles, scream and shout.]
 Rec-Sent: [sender]
 OpCall: [KN6PE]
 OpName: [Jim Oberhofer]
 Method: [Other]
 Other: [Packet]
 !/ADDON!

Subject line and message text fields are locked.

498

© Copyright 2011-2024 Santa Clara County ARES/RACES. All rights reserved.

102

Generic ICS-213 Form

- Use XSC ICS-213 Message Form in Santa Clara County
- Use Generic ICS-213 Message Form elsewhere
 - Communications to/from Regional EOC
 - Communications to/from other county EOCs

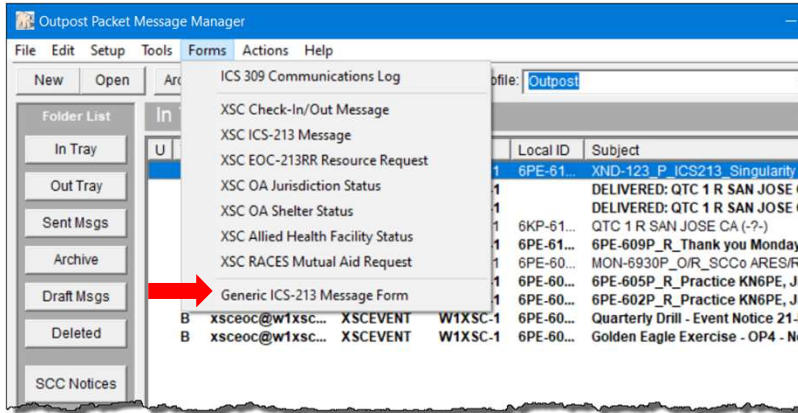

© Copyright 2011-2024 Santa Clara County ARES/RACES. All rights reserved.

103

8. WRAP UP

© Copyright 2011-2024 Santa Clara County ARES/RACES. All rights reserved.

104

Final Assignment

- Online Class Evaluation
 - Log into <https://www.scc-ares-races.org/activities/events.php>
Click “Submit Class Evaluation” in Events

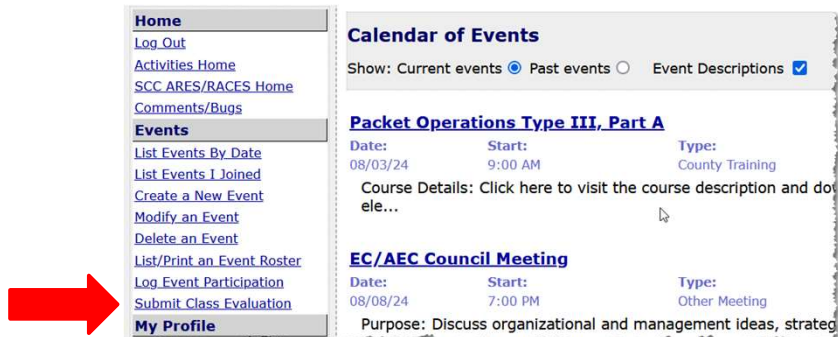

The screenshot shows the 'Calendar of Events' page on the SCC ARES/RACES website. On the left, there is a navigation menu with a red arrow pointing to the 'Submit Class Evaluation' link under the 'Events' section. The main content area displays a list of events. The first event is 'Packet Operations Type III, Part A' with a date of 08/03/24, starting at 9:00 AM, and of type 'County Training'. Below it is 'EC/AEC Council Meeting' with a date of 08/08/24, starting at 7:00 PM, and of type 'Other Meeting'. The purpose for this meeting is 'Discuss organizational and management ideas, strateg...'. There are radio buttons to filter by 'Current events' (selected), 'Past events', and a checked checkbox for 'Event Descriptions'.

- Submit your evaluation as soon as possible... after 1 week, the form will no longer be available for this class!

© Copyright 2011-2024 Santa Clara County ARES®/RACES. All rights reserved.

105

HOMEWORK!

- Complete the following tasks before attending the next class.
 1. Familiarize yourself with entire SCCo ARES/RACES Packet web page
 - <http://www.scc-ares-races.org/data/packet>
 2. Join the scc-packet group (packet@scc-ares-races.groups.io)
 3. Install Outpost and review the settings menus
 4. **Read and Understand the “Packet Network Addressing” web page**
 - <http://www.scc-ares-races.org/data/packet/packet-addressing.html> (linked from main packet page)
 - **Use packet groups.io email list for questions**
 5. From your packet station
 - Connect to your primary BBS and send yourself a message
 - Download, save, read and understand the SCCo Notices
 - Check in to the Mon/Tue packet net (see the SCCo packet web page)
 6. And... complete the SCC Packet Exercise Workbook!

© Copyright 2011-2024 Santa Clara County ARES®/RACES. All rights reserved.

106

SCCo RACES

Packet Exercise

Workbook

2024 edition

Contents

0	Overview	3
0.1	Introduction	3
0.2	Getting the most from this workbook	3
0.3	Before you begin	3
0.4	Other References	4
1	Setup	5
1.1	Before you begin	5
1.2	Finding your TNC's Com Port	5
1.3	Setting up Outpost	6
1.4	Sending a test message... to yourself (round-trip)	7
2	Working with Messages	8
2.1	Sending a message to someone else	8
2.2	Sending to multiple destinations	9
2.3	Sending to an email address	10
2.4	Sending PacketForm messages	11
2.5	Storing Messages: Customizing Folders	12
3	Customizing Message Handling	13
3.1	Setting up a Default destination	13
3.2	Automatic Message Printing	14
3.3	More Msg Settings: Message Numbering	16
3.4	Message Receipts	17
3.5	Setting up Tactical Calls	18
4	Other Settings	19
4.1	Automatic BBS Polling	19
4.2	Retrieving Messages	20
4.3	ICS309 Reporting	21
4.4	Setting up address book entries	22
4.5	Message Addressing	23
5	Localizing Packet	25
5.1	Polling for local bulletins	25
6	Advanced Message Handling	27
6.1	Sending a message from a text file	27
6.2	Sending a Spreadsheet .csv file	28
6.3	Sending an unknown form	29

© Copyright 2011-2024 Santa Clara County ARES/RACES. All rights reserved. 107

- ## For Your Information
- Download SCC Notices into Outpost
 - Store in Archive folder to save for reference
 - Check-In/Out
 - Frequencies (and BBS's)
 - Subject Line Format
 - Tactical Calls
 - Weekly Packet Practice
 - XSC Tactical Calls

 - Force a one-time SCC Notice download
 - Actions -> Force one-time bulletin retrieve
- © Copyright 2011-2024 Santa Clara County ARES/RACES. All rights reserved. 108

For Your Information

- These documents are recommended for your Go Kit
 - Packet Frequencies and BBS Assignments
 - Outpost Configuration Settings
 - Message Addressing
 - Standard Subject Line Format

- Download and print out a hardcopy

<http://www.scc-ares-races.org/data/packet>

© Copyright 2011-2024 Santa Clara County ARES®/RACES. All rights reserved.

109

Stay Current, Stay Informed

- Visit the County web site often
- Check the Announcement space
- Check the Packet page
- Check for updates often
- Take personal responsibility for keeping yourself and your equipment up-to-date

- Join the SCC-Packet group

packet@scc-ares-races.groups.io



**Keep your equipment,
software, and yourself
up to date**

© Copyright 2011-2024 Santa Clara County ARES®/RACES. All rights reserved.

The screenshot shows the website header with the logo and name "Santa Clara County, California ARES®/RACES". Below the header is a welcome message and a prominent "ANNOUNCEMENTS" section. The announcement states: "This is a Non-Emergency, Information Only Message: WBASH - Linking is down: The WBASH repeaters are being relocated during the next two to three weeks. Both the 2 meter and 440 WBASH repeaters will be usable from other temporary locations during the relocation. However, linking of WBASH to ARES1 for the Resource Net will not be available during this transition. All users that used WBASH should determine if they can reach either ARES1 or N9NAC during the interim. The relocation is expected to be completed by the 2nd week of July (06/29/22 KESTM) UPDATE: Repeaters have been successfully relocated but are awaiting some cabling before they can be turned on. This is expected to take another 2 to 3 weeks. The temporary repeaters are still operational but without the ability to link WBASH to the Resource Net (07/18/22 KESTM). Command Net: The WGGGF-UHF repeater is currently operating on reduced power. While it is being repaired, the KESNY-UHF repeater (443 275 (+) 107.2) will be used for the primary county Command Net repeater. WGGGF-UHF will be used as the backup Command Net. (3/2/20 NMECF)".

Below the announcement are several navigation sections: "Training & Events Calendar" with a list of upcoming events; "QUICK LINKS" including Alerts, Frequency Lists, and Services; "OPERATIONS" with links for activation info and standards; "DATA NETWORKING" with service and access information; "TRAINING & EVENTS" with calendar and sign-up options; "REFERENCE INFORMATION" with links to ARRL and band plans; and "ABOUT SCCo ARES/RACES" with information on county leadership.

Summary

- You should now understand
 - The role of a Packet Operator Type III
 - What packet is and why we use it
 - The Santa Clara County BBS network and BBS assignments
 - How to set up the baseline packet station
 - The use of Outpost and PackItForms
- Next Class – Packet III B
 - Operating Procedures
 - Troubleshoot a packet station
 - Bulletins and Message addressing
 - Send and receive PackItForms messages using Outpost

© Copyright 2011-2024 Santa Clara County ARES®/RACES. All rights reserved.

111

Thank You!

Please complete the Course Evaluation
and packet exercise homework
on or before next Saturday!

If you have questions or feedback about this or other training activities, you can join our Training discussion group.

<https://scc-ares-races.groups.io/g/packet>

Make sure you're signed up for the second part:
Packet Type III, Part B

Questions, comments, suggestions?
kn6pe@arrl.net

© Copyright 2011-2024 Santa Clara County ARES®/RACES. All rights reserved.

112